

Final Environmental Impact Statement

(Final Statement to FEA-DES-77-8)

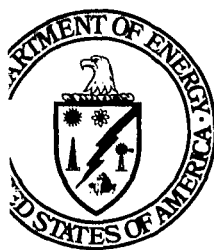

**STRATEGIC
PETROLEUM RESERVE**

Texoma Group Salt Domes

(West Hackberry Expansion, Black Bayou, Vinton, Big Hill)

**Cameron and Calcasieu Parishes,
Louisiana and Jefferson County, Texas**

U.S. DEPARTMENT OF ENERGY

November 1978

**Volume 2 of 5
Appendices A and B**

Final Environmental Impact Statement

(Final Statement to FEA-DES-77-8)

STRATEGIC PETROLEUM RESERVE

Texoma Group Salt Domes

(West Hackberry Expansion, Black Bayou, Vinton, Big Hill)

Cameron and Calcasieu Parishes, Louisiana and Jefferson County, Texas

Responsible Official

Ruth C. Clusen
Assistant Secretary for Environment

U.S. DEPARTMENT OF ENERGY

Washington, D.C. 20545

November 1978

**Volume 2 of 5
Appendices A and B**

VOLUME II - TABLE OF CONTENTS

APPENDIX A - DESCRIPTION OF THE PROJECT	A.1-1
A.1 INTRODUCTION	A.1-1
A.2 CONCEPT OF STORAGE IN SOLUTION MINED CAVERNS IN SALT DOMES	A.2-1
A.3 GENERAL CAVERN CONSTRUCTION TECHNIQUES	A.3-1
A.4 PROPOSED STORAGE SITE - WEST HACKBERRY EXPANSION	A.4-1
A.5 ALTERNATIVE STORAGE SITE - BLACK BAYOU	A.5-1
A.6 ALTERNATIVE STORAGE SITE - VINTON SALT DOME	A.6-1
A.7 ALTERNATIVE STORAGE SITE - BIG HILL SALT DOME	A.7-1
A.8 SUMMARY	A.8-1
APPENDIX B - DESCRIPTION OF THE ENVIRONMENT	B.2-1
B.1 INTRODUCTION	B.2-1
B.2 REGIONAL ENVIRONMENT	B.2-1
B.3 SITE SPECIFIC ENVIRONMENT	B.3-1

APPENDIX A

DESCRIPTION OF THE PROJECT

A.1 INTRODUCTION

The candidate SPR sites in the Texoma group of salt domes are located in the southwestern corner of Louisiana and the adjacent southeastern corner of Texas, within a 40 mile radius of Nederland, Texas (See Figure A.1-1) The Sun Oil Company terminal at Nederland would serve as the crude oil supply terminal for the designated SPR storage site. During subsequent strategic distribution, the SPR oil would be transported to inland refineries through the Texoma Pipeline, which initiates at the Sun Terminal, other inland pipelines, and also reloaded onto tankers for distribution to the East Coast or the Caribbean refineries.

The West Hackberry salt dome is the proposed site for SPR development in the Texoma group of salt domes. It is located in north-central Cameron Parish of southwestern Louisiana, approximately 40 miles east of the Sun Terminal which is located at Nederland, Texas. The storage of 60 million barrels of oil in existing solution caverns at West Hackberry was evaluated as a candidate plan for the ESR program, and a final EIS (FES 76/77-4) addressing the effects of the plan was published in January 1977, with a supplement addressing facility design changes following in April, 1977. The West Hackberry facility is currently being developed as part of the ESR, and a proposed SPR expansion of the site for an additional storage capacity of 150 million barrels is discussed in this document.

Three alternative sites are also discussed in this document as proposed candidates for SPR development associated with the Texoma system. One or a combination of these three sites may be developed such that the total SPR storage capacity for the Texoma group of salt domes will be 150 million barrels. In this document, however, each candidate site is treated separately for organizational purposes. The Black Bayou dome is located in northwestern Cameron Parish of southwestern Louisiana about 30 miles east of the Nederland terminal. It could be developed to a capacity of 150 million barrels of oil storage. The Vinton dome is located in southwestern Calcasieu Parish of southwestern Louisiana, a distance 30

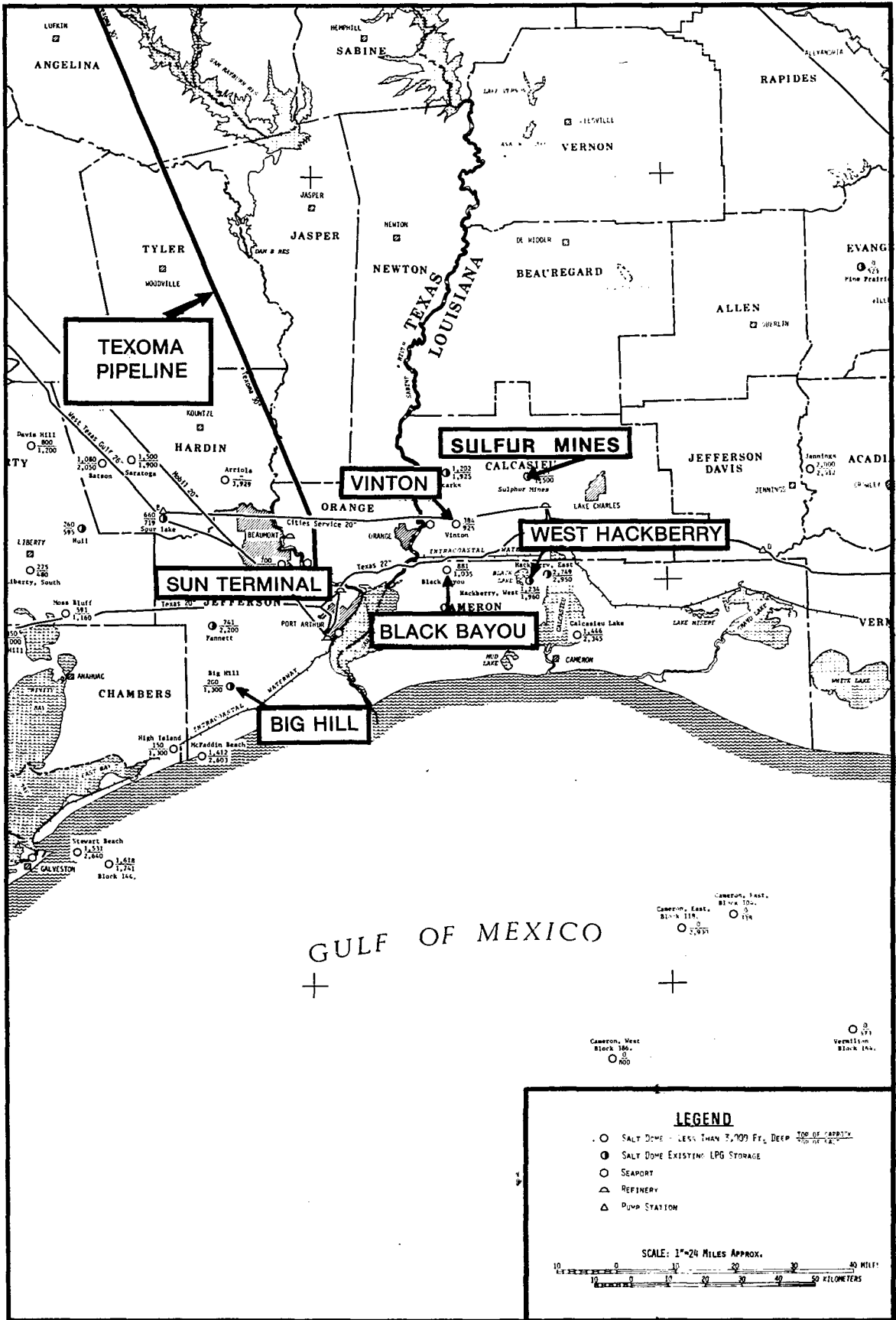

Figure A.1-1 TEXOMA GROUP SALT DOMES

A.1-2

miles northeast of Nederland. Development here could provide 50 million barrels of storage capacity. The Big Hill dome is located in southwestern Jefferson County, Texas, about 25 miles southwest of the Texoma terminal at Nederland. It could be developed to a 100 million barrel storage capacity.

All development of new storage capacity for these four salt domes in the Texoma group of SPR sites would require newly mined cavities. A system of wells would be constructed and the storage space in the salt would be created by a solution mining process. The concept of this method of oil storage development is discussed in Section A.2.

The oil storage facilities are presently in the preliminary design stage. Engineering feasibility analyses have been prepared as the basis for evaluation of the socioeconomic and environmental impacts of the project. Future studies would provide detailed information on equipment design, construction methodology, and operational procedures. For the purpose of this EIS, project development is assumed to follow standard industry practice, consistent with good engineering principles and a concern for environmental values. Whenever reasonable doubt exists about the ultimate performance characteristics or environmental effects of any phase of the project, a worst-case analysis of potential impacts is provided.

This document also includes a discussion of the impacts which would result from the construction and operation of the proposed raw water supply system for the Sulphur Mines SPR site. Recent findings by DOE have shown that the supply of fresh-water from the location proposed in the Sulphur Mines FES might be inadequate to supply the needs of the Sulphur Mines site during drawdown, so a new intake location and associated pipeline corridors have been examined as a possible alternative to the water intake system proposed in the Sulphur Mines Final Environmental Impact Statement. The new intake location would be the same as that proposed for the West Hackberry SPR site development and was chosen as an environmentally desirable withdrawal point. The impacts relating to the Sulphur Mines intake location and pipeline corridors as discussed in this document are supplemental to information contained in the Sulphur Mines Final Environmental Impact Statement (DOE/EIS-0010).

A.2 CONCEPT OF STORAGE IN SOLUTION MINED CAVERNS IN SALT DOMES

The use of salt domes for petroleum storage is attractive because of both the relatively low cost of such bulk storage and the extreme geological stability of rock salt masses. In addition, oil storage deep underground provides security from natural catastrophes or sabotage.

Salt domes are a major source of brine feedstock for chemical and salt industries in the Gulf region. Solution cavities are formed by dissolving the salt with circulating water and pumping out the resulting brine. The process requires a large volume of leach water (about 7 barrels fresh water or about 8 barrels seawater for every barrel of space created). Some of these cavities are currently used to store a number of petroleum products. In the U. S., the products stored are primarily LPG (Liquefied Petroleum Gas) products such as propane, ethylene, etc., as well as some fuel oil. Although crude oil storage in solution cavities does not present particular technical problems, it has been practiced principally in other countries.

In the Texoma group of salt domes, the West Hackberry dome contains existing cavities resulting from brining operations. These cavities, as well as other existing cavities in salt domes, have been selected and are being developed for use in the ESR program because they require less time to prepare for oil storage than creating new salt caverns.

Approximately 900 cavities with a total capacity of 300 million barrels are known to exist in salt domes and bedded salt formations in the United States. In some cases it is feasible to enlarge existing cavities or to leach additional cavities at selected sites. New cavity construction is planned for the SPR development at West Hackberry and other alternative sites.

A.3 GENERAL CAVERN CONSTRUCTION TECHNIQUES

The development of oil storage capacity at the four proposed sites requires newly leached space. The drilling and cavern construction techniques associated with the facility development are discussed in detail in Appendix J. A brief summary follows.

Wells would be drilled into the salt mass to the projected bottom of each cavern, using conventional "oil field" drilling technology. The wells would be from 3,600 to 3,800 feet deep. After all casings are cemented in place and the well is equipped with displacement tubings and wellhead, a sump would be leached under the planned cavern to accommodate the 3 to 7 percent insolubles normally present in the salt. The fundamental technique of cavern development is to inject fresh water into the well, allow time for the water to dissolve the salt, and then replace the resulting brine from the well. As the salt dissolves, the borehole enlarges and eventually forms a cavern.

There are generally two methods of cavern construction under consideration for use in the SPR program. They are being addressed in this document as co-proposals.

A.3-1 Separate Leach Then Fill Process

The engineering system descriptions used in this document, including flow rates and development timetables, are based upon the separate leach then fill process of cavern development. In this process, the caverns would first be leached to full size by injecting only raw water and disposing of the resulting brine. Then the wellhead would be adapted for oil injection and brine withdrawal. The cavern would remain full of stored oil or brine at all times. To remove the oil would involve the injection of water into the bottom of the cavern which would displace the oil out the top. Figure A.3-1 is a simplified diagram showing a developing cavern equipped with necessary displacement tubing and wellhead.

A.3-2 Simultaneous Leach and Fill Process

As a co-proposal, a newer simultaneous leach and fill process would be tried. Essentially, this process would allow for the early storage of oil as the cavern leaching progresses.

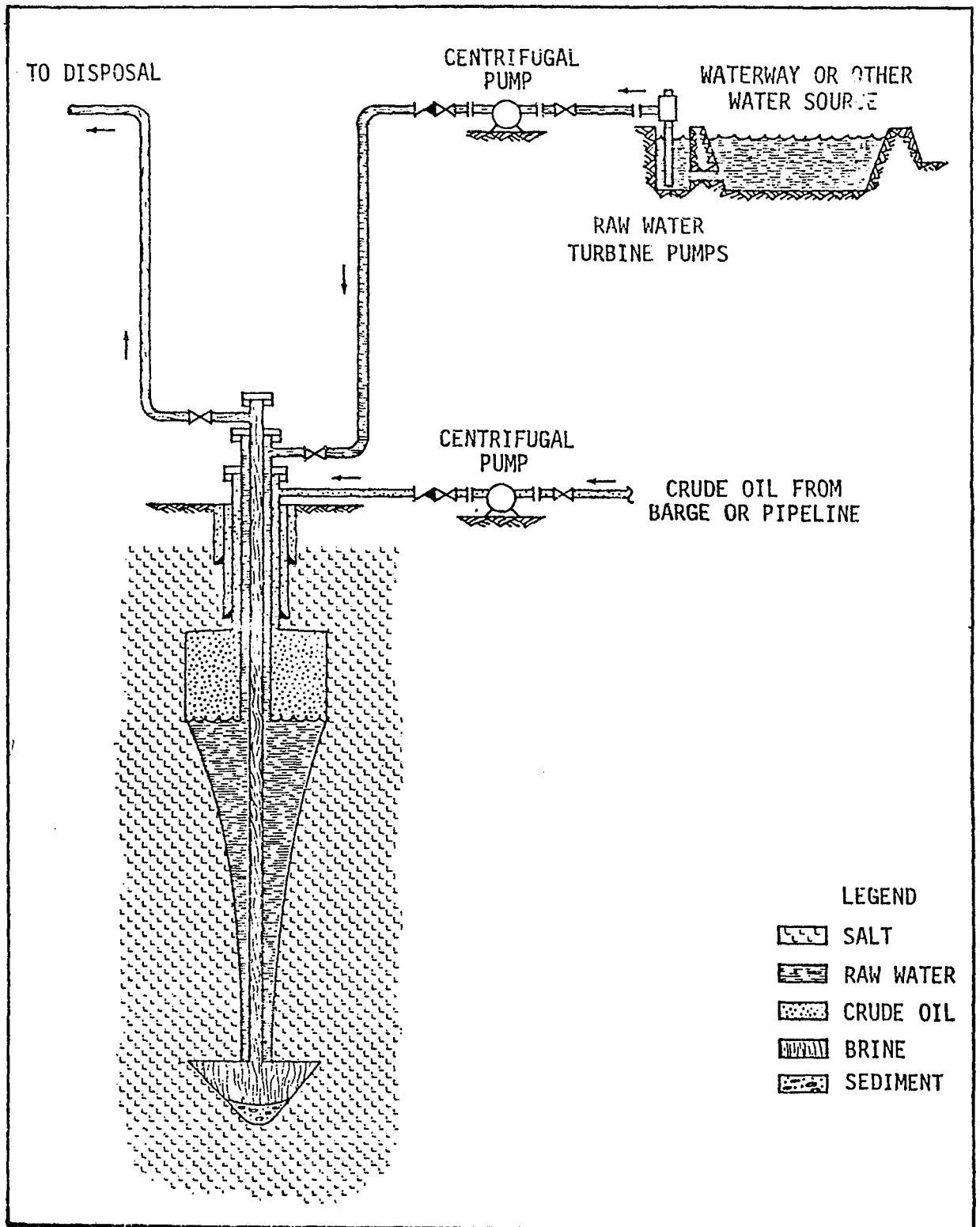

Figure A.3-1 Typical Solution Cavities in Salt Formations

The amount of oil which would be stored at the top of the cavern could be increased as the cavern is enlarged by leaching toward the bottom. When the cavern reaches full size, approximately 90 percent of the oil to be stored would be in place. This process is still an untried technology in this country, DOE plans to verify it through a test well before it is implemented for the general program. This technology is being used successfully in West Germany.

Oil injection rates and water supply rates for the simultaneous leach and fill process would be somewhat less than those required for the separate leach then fill process. Brine disposal rates would essentially be the same during cavern leaching which presents higher brine rates than cavern filling. Therefore, the separate leach then fill process would present the worst-case for environmental impact consideration, and it is this more extreme case which is described in the following sections for environmental impact assessment.

A.4 PROPOSED STORAGE SITE - WEST HACKBERRY EXPANSION

The West Hackberry facility as currently designed would satisfy a total of 210 million barrels of the SPR crude oil storage requirements in the Texoma/Lake Charles/Beaumont storage region. The development proposed herein would be a 150 million barrel expansion of the ESR facility of 60 million barrels which is described in the Final Environmental Impact Statement for the West Hackberry Salt Dome Early Storage Reserve (FES 76/77-4, FEA 1977a) and the Supplement to FES 76/77-4 (FEA 1977b).

A.4.1 Location

The West Hackberry salt dome is located in north-central Cameron Parish of southwestern Louisiana (see Figure A.4-1). The proposed site is approximately 20 miles southwest of the city of Lake Charles, Louisiana, and 16 miles north of the Gulf of Mexico. Black Lake, a 3.4 square mile shallow body of water, lies just to the north and partly covers a portion of the area over the salt dome. Hackberry, the local unincorporated town of 1,300 population, and the Calcasieu Ship Channel are approximately 4 miles east of the site. Sabine National Wildlife Refuge lies approximately 2 miles to the south.

Portions of the dome were recently used by Olin Corporation for brine production and by Cities Services for hydrocarbon product storage. The dome area is extensively developed with hundreds of oil and gas wells located on its perimeter. Little or no mining from the cap rock has taken place on the dome, and no cavern development has taken place over the area of the salt dome proposed for SPR expansion of the site.

About 220 acres of West Hackberry dome property formerly leased by Olin was acquired by FEA on April 18, 1977 for the ESR onsite developments. Cities Services occupies about 80 acres on the middle portion of the dome. Amoco owns a considerable amount of area, especially over the marsh areas on the northeastern half of the dome. The balance of the dome acreage not under water is under private ownership by various families. Approximately 250 acres within the -2000 ft salt contour are in this category.

The salt dome exhibits two topographic expressions. The western portion of the dome is overlain by a definite mounded area from 2 to 21 feet above mean sea level. It is the

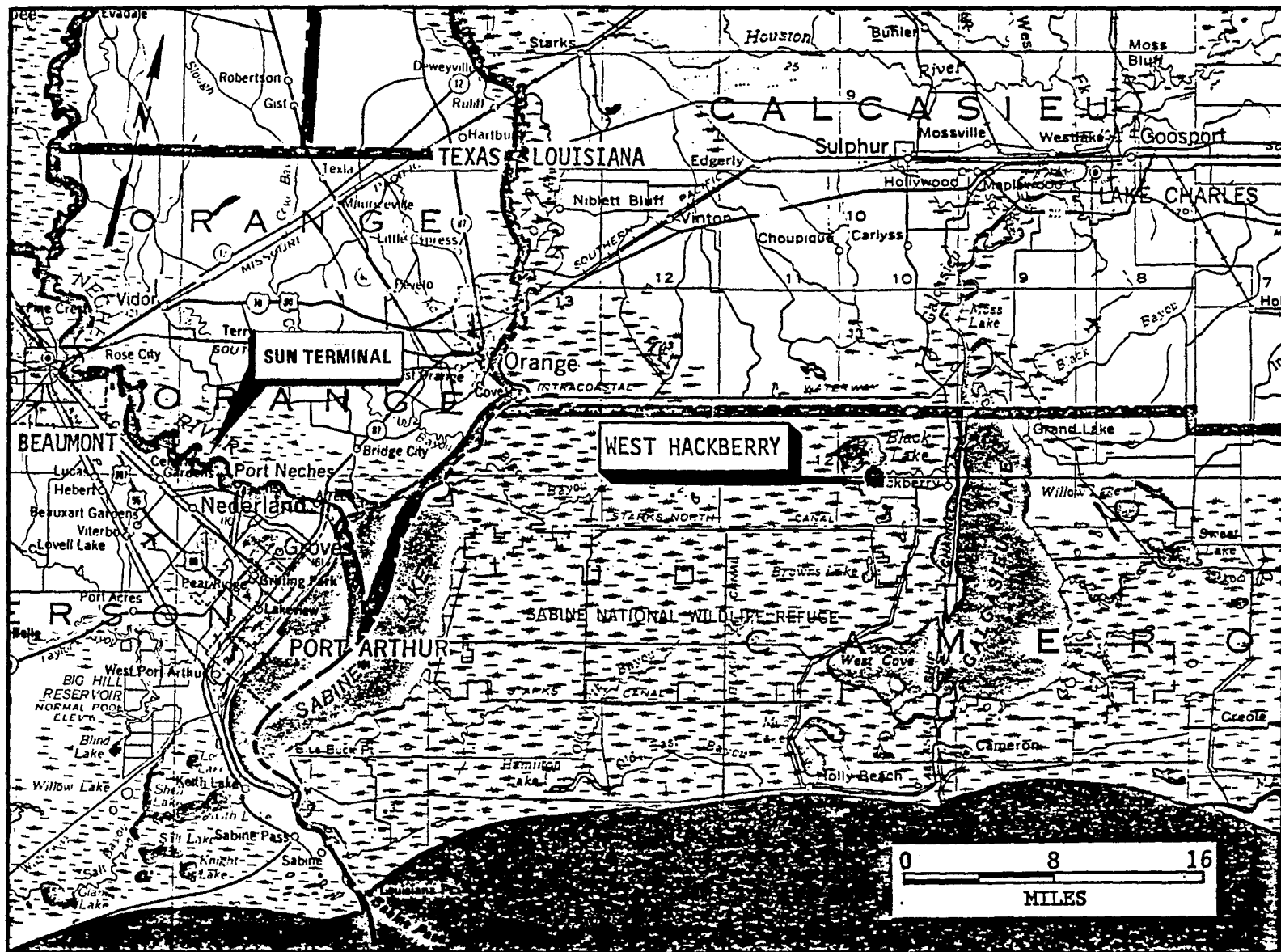

Figure A.4-1 Location Map - West Hackberry Dome

highest point in Cameron Parish with an area of about 890 acres elevated above 5 feet, (48.6% of the area above the -2,000 feet depth to salt contour). The eastern half of the dome area is covered by bayous and marsh.

Road access to the dome from Lake Charles is via State Highway No. 27. Parish Road No. 390 provides access from Hackberry. A network of gravel and shell roads serves the brining and storage facilities on the western portion of the dome. The eastern portion of the dome is served by canals allowing barge access to most of the area.

Barge access to Black Lake from the Intracoastal Waterway (ICW) is via Alkali Ditch, an 80 to 150 foot wide canal some 3.8 miles long. This canal is presently navigable by 6 to 7 foot draft barges. The site is favorably located with respect to ship terminals at Lake Charles (see Figure A.4-1).

West Hackberry is near existing pipelines. The Sun Terminal, which is the initiating point for the 30-inch Texoma pipeline at Nederland, Texas, is located about 40 miles to the west. An oil distribution pipeline connecting West Hackberry with the Sun Terminal at Nederland is under construction for ESR development at West Hackberry, and would be used in the SPR development.

Other than the proposed means of distribution, local refineries could be connected to the site by new and existing pipelines. The proposed facilities at West Hackberry are located within 55 miles of eight major refineries. Table A.4-1 lists these refineries.

A.4.2 Capacity

The proposed expansion of the West Hackberry storage site would entail the development of 15 new solution caverns of 10 million barrels (mmb) each, thus accommodating 150 mmb of new storage capacity. The ESR facility would have a capacity of 60 mmb in five existing caverns, giving a total capacity of 210 mmb for the combined ESR and SPR facilities.

Crude oil storage at West Hackberry has been considered on the basis of the net volume of initial cavern capacity available rather than the gross cavern volume. In any salt storage cavern facility, allowances have to be made so that a cycling program can be conducted without repositioning the displacement casing. The net usable volume of cavern capacity, in the case of fresh water displacement, would increase

Table A.4-1 Beaumont/Port Arthur/Lake Charles Refineries

<u>Company and Location</u>	<u>Capacity(BPD)</u>	<u>Distance(Mi.) from West Hackberry</u>
Cities Service - Lake Charles	268,000	14
Conoco - Lake Charles	83,000	18
American Petrofina - Port Arthur	26,000	45
Gulf - Port Arthur	312,100	45
Mobil - Beaumont	325,000	54
Texaco - Port Arthur	406,000	45
Texaco - Port Neches	47,000	44
Union - Nederland	127,000	48

after each cycle. The West Hackberry facility has been designed for 5 fill and withdrawal cycles, which would create a gross volume enlargement of about 77 percent. There must also be sufficient volume allowed below the displacement casing to store the insoluble material which would fall out as the salt is dissolved. The present sizing of surface wellheads, piping and pumps, however, is premised on the design rate associated with 150-day oil withdrawal operations, considering the initial 10 mmb per well capacity only.

The West Hackberry salt dome is among the largest in the Gulf Coast region with approximately 1,750 acres within the -2000 ft. depth to salt contour. About 900 acres of this lies under marshland. Of the dry land portion over the dome, the proposed ESR and SPR sites would occupy about 380 acres. The remaining dry land (470 acres), could accommodate approximately 50 additional 10 million barrel storage wells at the 600 ft. spacing. Thus, if all dry land on the dome were developed for crude storage, there is enough salt area for a total of 710 million barrels of storage capacity.

A.4.3 General Systems Description

The general systems components required for a crude oil storage facility in solution mined caverns in a salt dome include the storage wells, a central plant for all pumping and metering equipment, a raw water supply system, a brine disposal system, and a crude oil distribution system. A schematic diagram of a typical facility is shown in Figure A.4-2.

The presently planned expansion of the West Hackberry site would involve the leaching of 15 new caverns on a site adjacent to the ESR site being developed on the dry land portion of the dome (see Figure A.4-3). To create the new caverns requires pumping fresh water through wells into the salt and displacing salt brine out through concentric well tubings (see Appendix J).

The central plant location and raw water supply station would be the same as planned for the ESR facility. The central leach plant, including pumps, surge ponds, and surface tanks, would be located on the ESR site near the site of the former Olin wash plant (see Figure A.4-3). The raw water intake station would be located on the Intracoastal Waterway approximately 4 miles north-northwest of the central plant. The major development required for the SPR expansion of the facility would be the construction of the 15 new wells with connecting roads and pipelines on a 160-acre tract immediately west of the ESR facility.

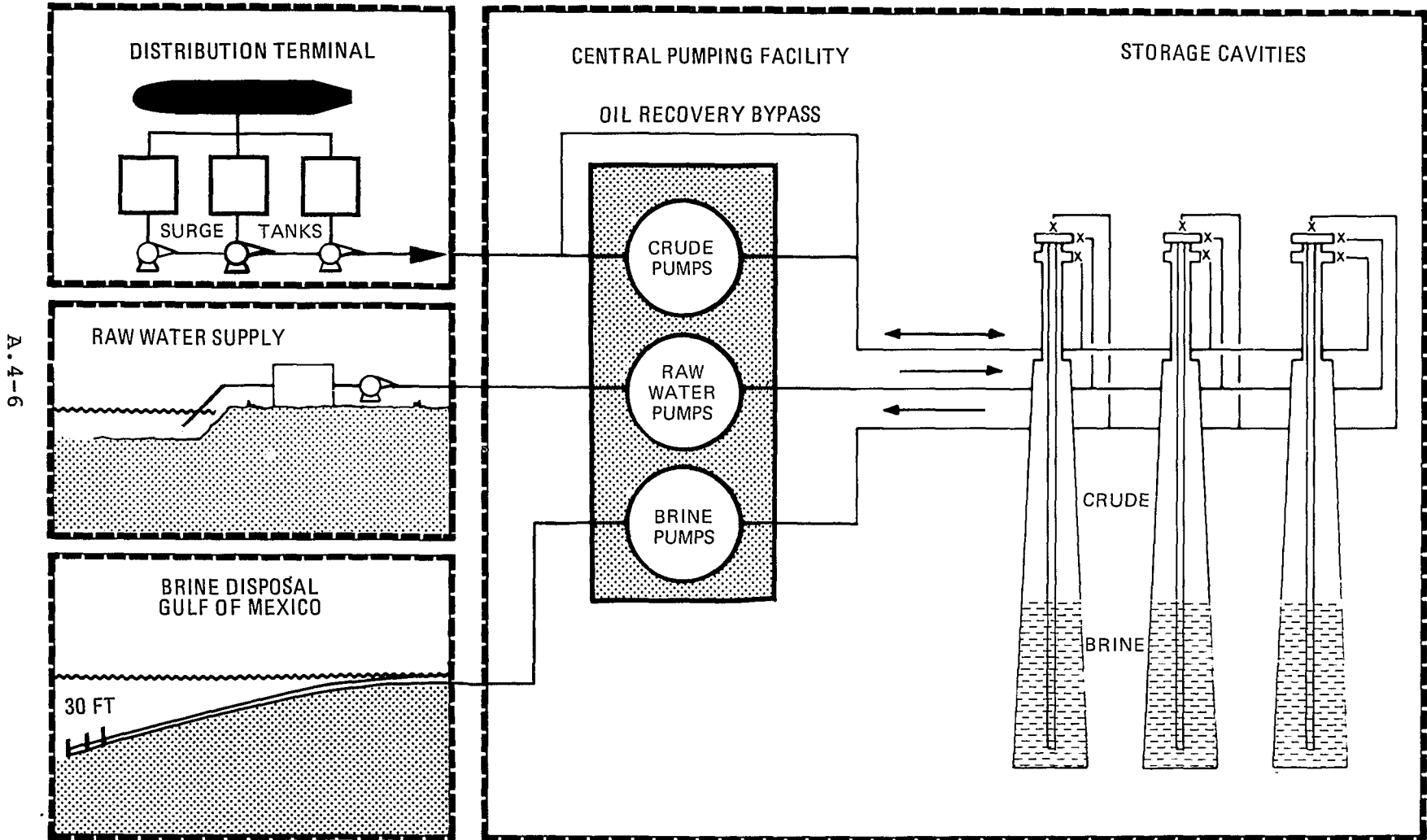

Figure A.4-2 Schematic Diagram of Typical Oil Storage Systems

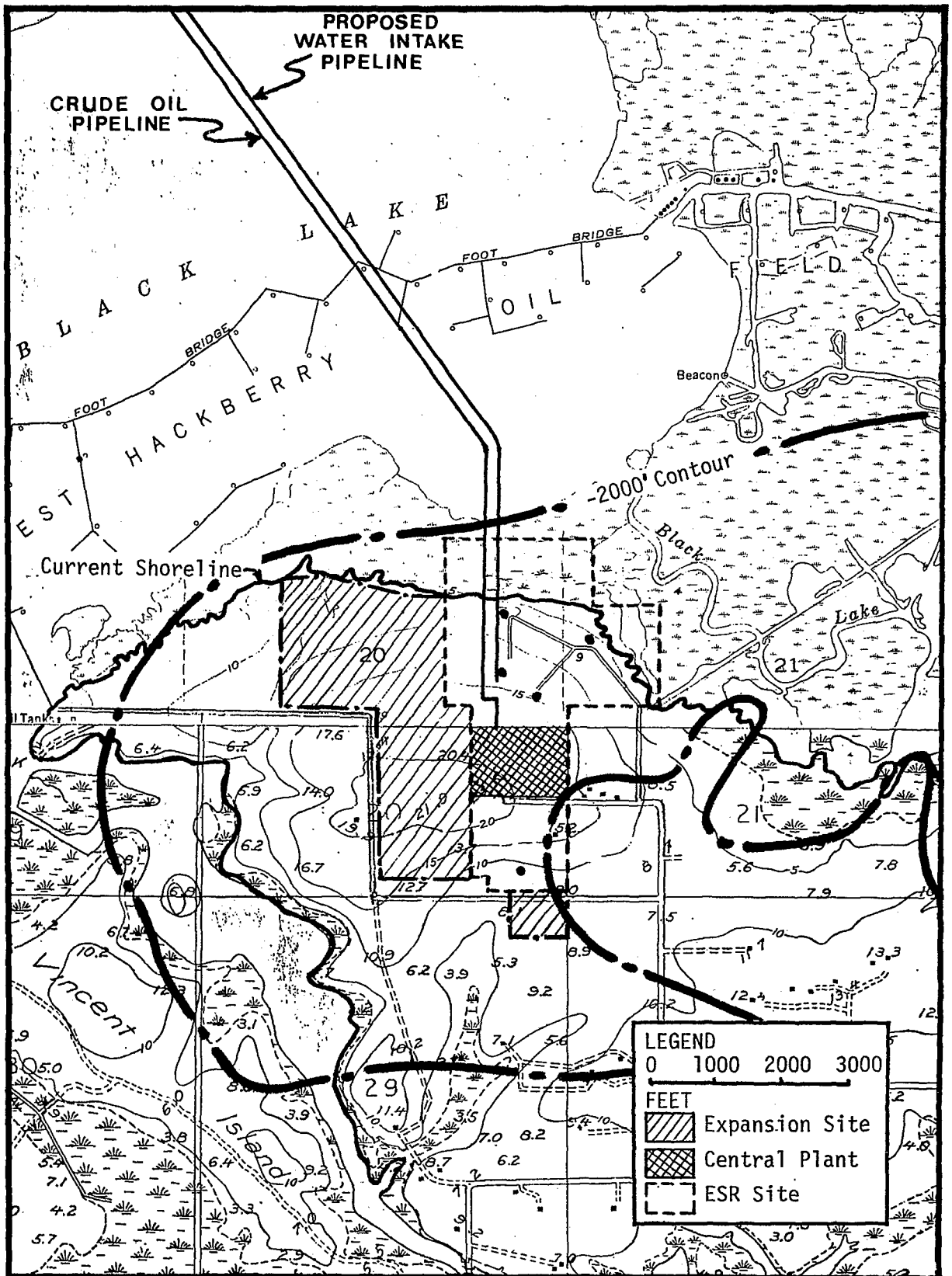

Figure A.4-3 Site Development Plan - West Hackberry

The proposed brine disposal system for the ESR facility is a deep well injection system being constructed south of West Hackberry dome. However, because of the increased volume of brine produced, the expanded SPR facility, would require a pipeline to be constructed to the Gulf of Mexico for direct disposal offshore. The proposed route for this pipeline is discussed in Section A.4.4.1.4.

The crude oil supplies to fill the caverns would be piped from the Sun Terminal at Nederland, Texas through a 41.5 mile pipeline which has been constructed for the ESR system (see Figure A.4-4). The initial filling of the caverns is planned as a separate operational phase after the cavern leaching process has been completed for the 15 expansion wells.

For withdrawal of the stored oil, the intake station on the Intracoastal Waterway (ICW) would be designed to supply the water necessary to displace the 150 million barrels (mmb) of oil stored at the expansion site as well as the 60 mmb stored at the original ESR site. It would be sufficient to handle the 24 mmb to be stored at Sulphur Mines (see DOE/EIS 0010). The displaced oil would be transported by pipeline to the Sun Terminal for distribution by tanker as well as the inland pipeline network.

A.4.4 Site Development

A.4.4.1 Proposed Physical Facilities

A.4.4.1.1 Site Layout

The 15 additional wells to be drilled for the expansion of the SPR facility at West Hackberry would be spaced at a minimum of 600 feet apart and would all be located on dry land (see Figure A.4-5). New roadways would be required for access to the wells. Approximately 1.8 miles would be needed. All roadways would be located on dry land, requiring a minimum of clearing and grading (see Figure A.4-5). Pipelines connecting the wells and the central plant would be laid beside the access roadways. At this particular site, it has been assumed the various onsite pipeline connectors would be buried. This is an accepted method for plants located on high and dry land. A pipeline flow diagram for the SPR facility is shown in Figure A.4-6.

A.4.4.1.2 Central Plant Facilities

The central plant facilities constructed for the ESR plant would also serve the SPR expansion site. The plant as currently designed includes all pumps and pump structures, control buildings, surge ponds, surface tankage, metering, and transformers (see Figure A.4-7). The plant would be

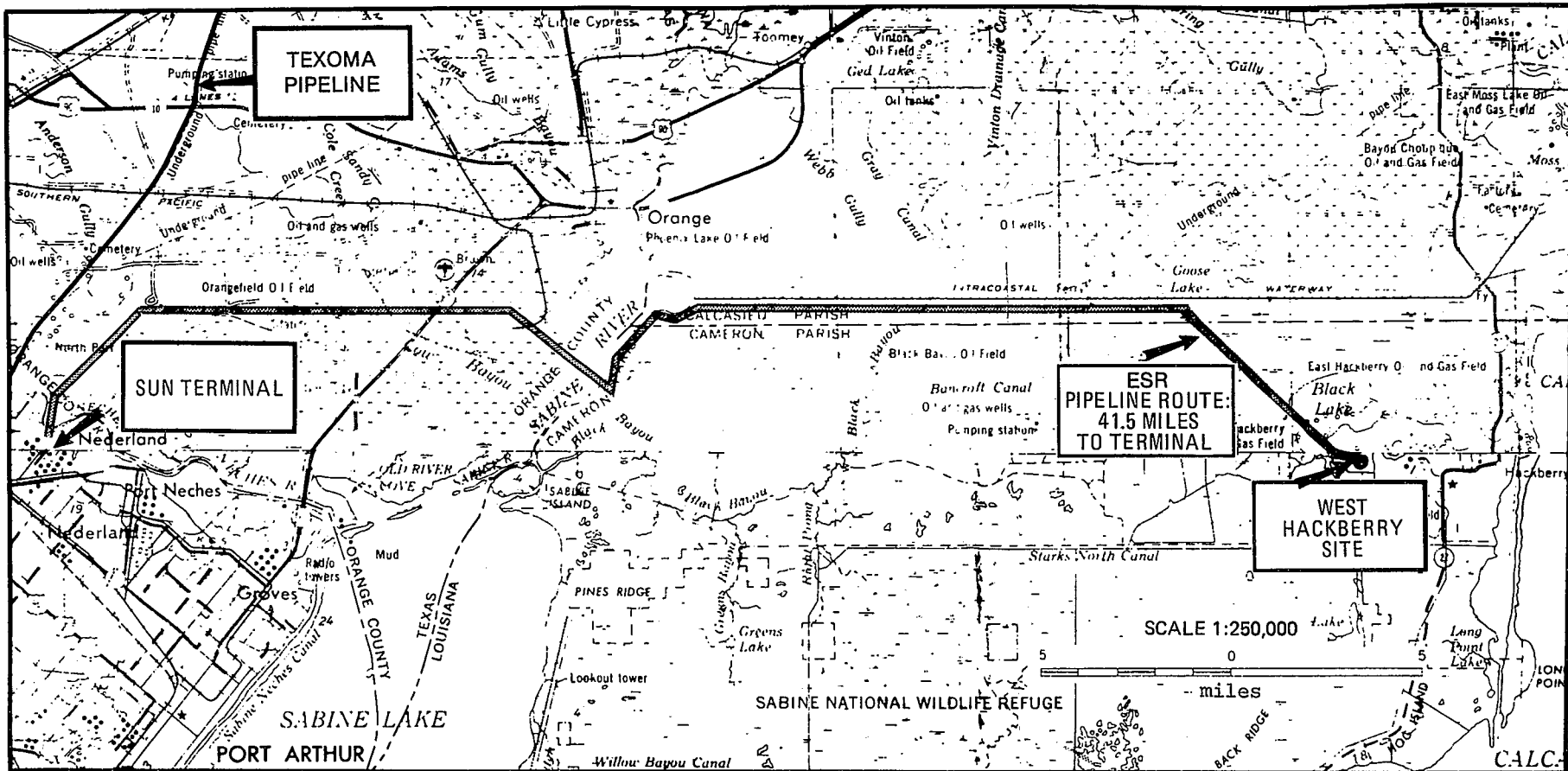

Figure A.4-4 Oil Distribution Pipeline Route

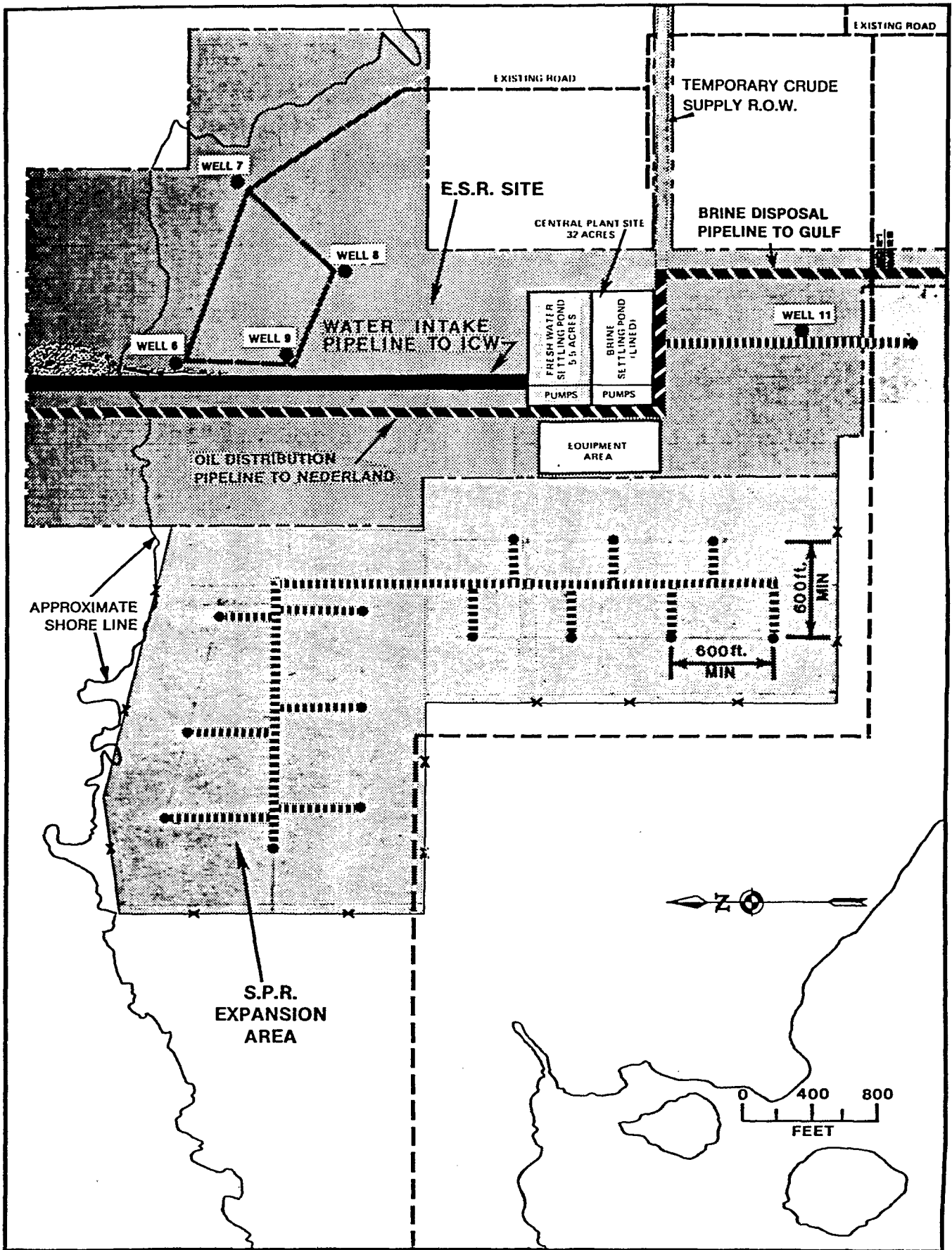

Figure A.4-5 Storage Site Layout-West Hackberry

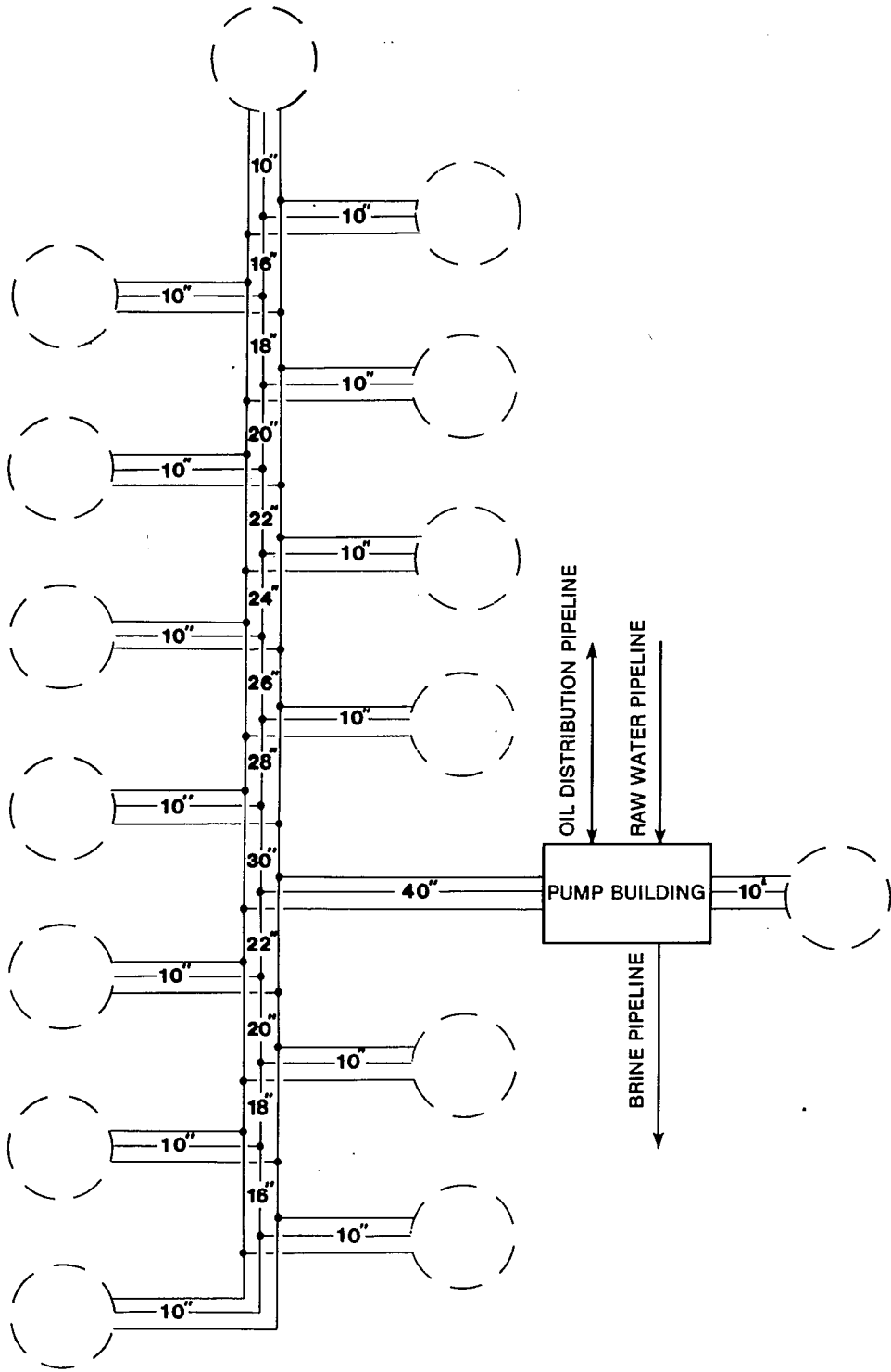

Figure A.4-6 Pipeline Flow Diagram

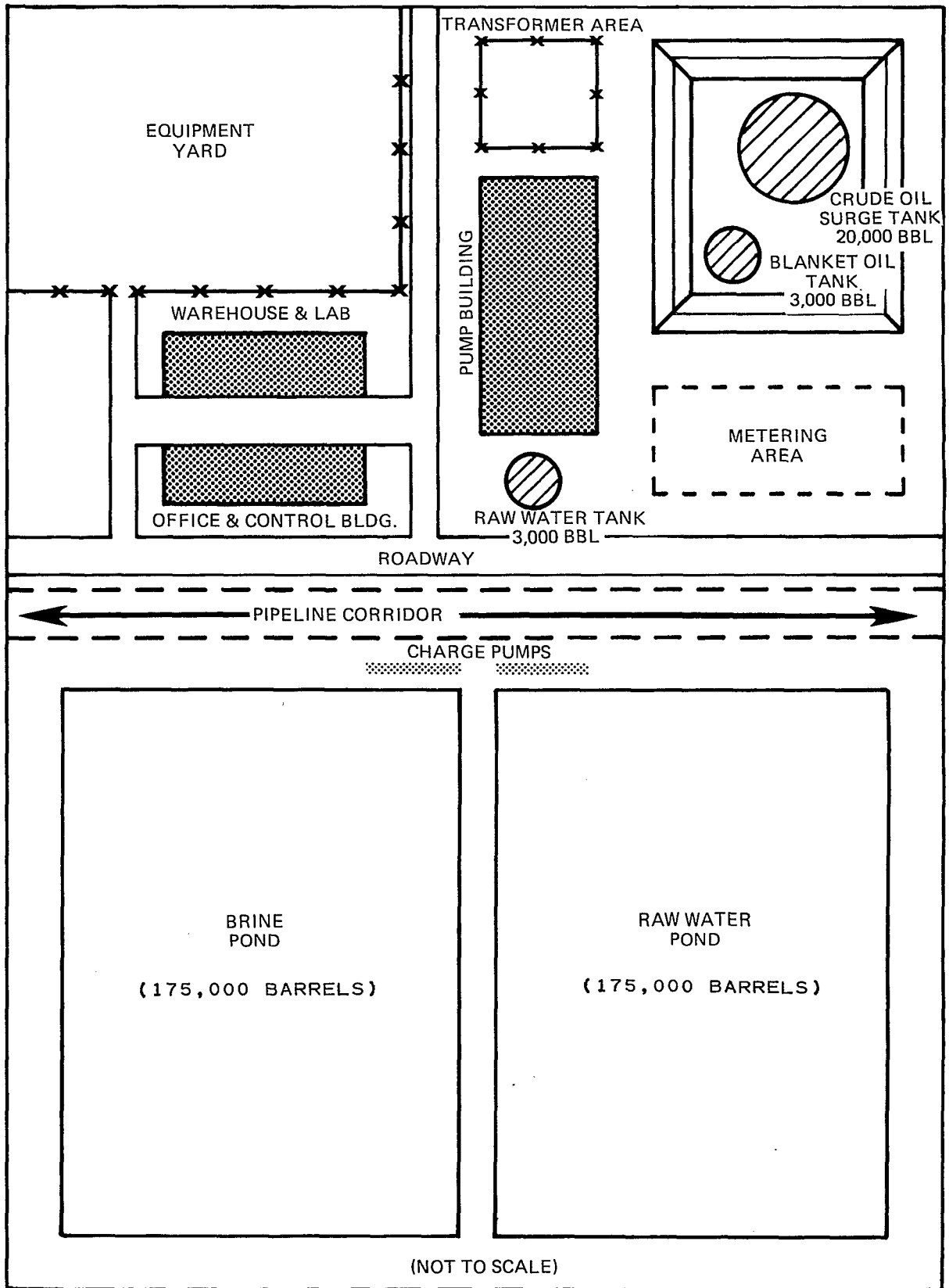

Figure A.4-7 Central Plant - Preliminary Layout

located on a 40-acre tract on the ESR site near the original Olin wash plant (see Figure A.4-5).

Buildings would be required to house the main office, all electrical control equipment, a repair shop, and a chemical lab. At this lab, brine samples would be analyzed to calculate the rate of new leaching. Also, tests would be conducted on crude oil samples to determine their compatibility with other stored oils. Buildings would be of standard steel construction and would be built upon concrete slabs. In cases of insufficient soil bearing strength, reinforced concrete piles would support beams upon which the floor would be laid.

The various pumps required for leaching, oil injection, brine disposal, and pipeline operation would be located in a main pump building or other appropriate sound attenuating structures. A list of the required pumps is given in Table A.4-2. As shown, standby pumps are provided to insure steady operation. Power for the electric motor drives and equipment would be supplied by local utilities.

Also indicated in Figure A.4-7 are tanks and ponds as needed for operation and construction (described in later sections). Retention dikes are planned for all oil tankage as required for oil spill containment (40 CFR 112.7). Dike enclosures are a standard engineering practice for compliance with these regulations.

A.4.4.1.3 Raw Water System

The raw water supply proposed for both the ESR and SPR expansion at West Hackberry would be located on the Intracoastal Waterway, approximately 4 miles NNW of the central plant. The intake structure would consist of a platform (10 ft x 10 ft) supported on pilings with multiple screens for minimizing impingement of trash and organisms. A sump would be dredged from the ICW near the shore in the form of an inlet. The sump channel would be about 30 ft wide and taper from 8 ft deep at the line to 17 ft deep at the shore, requiring approximately 7000 cubic yards of dredge. The spoil would be deposited on adjacent dry land, covering 1 to 2 acres up to 5 feet deep.

Water would be transferred to the West Hackberry and Sulphur Mines storage sites through a 42-inch diameter pipeline by 4 pumps located at the intake station. Figure A.4-8 indicates the route of the raw water line from the Sulphur Mines site to the intake location. At West Hackberry the water would flow into a 175,000-barrel settling and surge pond at the central plant area (see Figure A.4-7). The booster pumps (7 at 900 hp each), would supply the manifold side of the water

Table A.4-2 Pump Requirements - West Hackberry

Pump Task	Quantity	Horse-power	Discharge Pressure (psi)	Total Design Flow Rate (barrels/day)
Water Supply	4	400	45	1,470,000
	1 Stand-by	400		
Water Booster	7	900	255	1,470,000
	1 Stand-by	900		
Brine Disposal (Water Booster during Displ.)	7 (4 Stand-by)	600	150	1,010,000*
	11	600	260	1,470,000
Water Injection	11	1500	718	1,470,000
	2 Stand-by	1500		
Oil Transfer	11	1500	765	1,400,000
Injection	1 (1 Stand-by)	1500	770	175,000
Blanket Oil	1	100	1000	3,500*
Oil Transfer at Terminal	2	900	600	175,000
	1	500		
	1 Stand-by	500		
Tanker Load	2	1500	100	840,000

*Due to leaching SPR expansion caverns.
Other rates occur during simultaneous ESR and SPR operation.

A.4-14

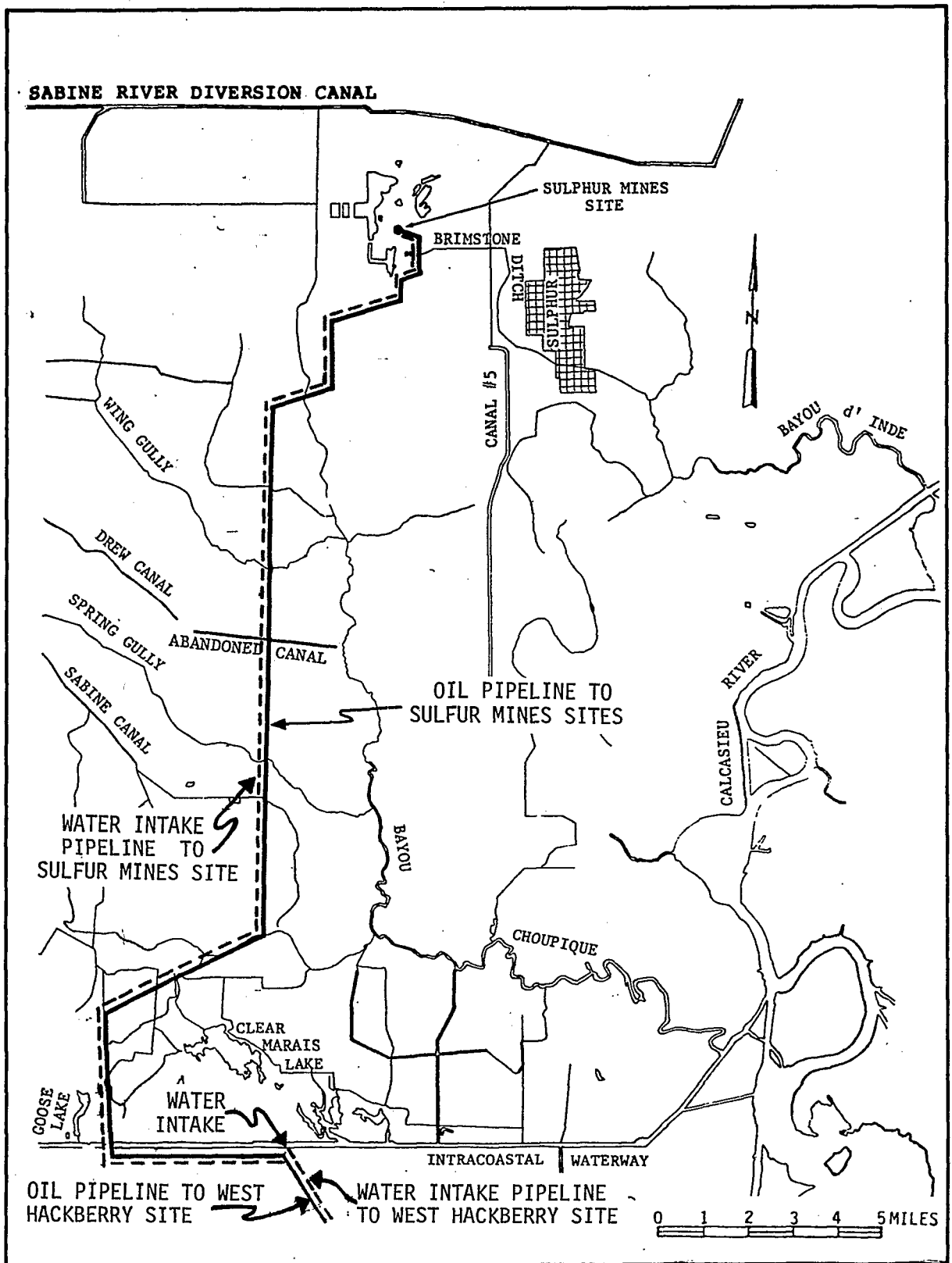

FIGURE A.4- 8 Oil and Water Intake Pipeline Systems For Sulfur Mines.

injection pumps (11 at 1500 hp each). The water would be injected into the caverns at a 718 psi head pressure. The 3,000 barrel water tank located on site would be used for start-up operations only.

During the initial SPR leaching operations at West Hackberry, the design water flow rate would be 2,000 gpm (68,600 barrels/day) per 10 mmb cavern. For the leaching of 150 million barrels capacity at this site, a total of 30,000 gpm (1.03 million barrels/day for 38 months would be required. To leach one barrel of storage volume requires 7 to 8 barrels of raw water, depending upon the initial salinity of the water. At the proposed leach rate, new space would be created in each cavern at a rate of 255 gpm (8,750 barrels/day).

For water supply during crude oil withdrawal operations at West Hackberry and Sulphur Mines, the water intake equipment would be designed to provide the 42,875 gpm (1.47 million barrels/day) necessary to displace 210 mmb in a period of 150 days, since displacement requires 5 percent more water than the amount of oil displaced due to a slight compression of the fluids. Intake structures would be constructed to insure that the induced velocities would remain below 0.5 ft/sec to minimize problems of organisms clogging the screens or being entrained. For withdrawal of the stored oil, the intake/pumping station on the Intracoastal Waterway (ICW) would be designed to supply the water necessary to displace the 150 million barrels (mmb) of oil stored at the expansion site as well as the 60 mmb stored at the original ESR site. Water pumps at the ICW would be electric powered and supplied with power via submarine power cables laid along the water intake pipeline corridor. The intake/pumping station would also be sufficient to handle the 24 mmb to be stored at Sulphur Mines (see DOE/EIS 0010). The displaced oil would be transported by the same pipeline to the Sun Terminal for distribution by tanker and inland pipelines.

A.4.4.1.4 Brine Disposal System

The brine disposal system planned for the SPR expansion at West Hackberry would consist of a 24.8 mile pipeline to a location in the Gulf of Mexico for direct disposal into the sea (see Figure A.4-8). The proposed route would parallel the Calcasieu Ship Channel to the Gulf and extend offshore for approximately 7 miles to a diffuser located in 30 feet of water.

The leaching process would produce a less-than-saturated brine at about 230 ppt (parts per thousand) concentration. During the initial leaching process, brine would leave the caverns at a combined rate of 29,450 gpm (1.01 million barrels/day),

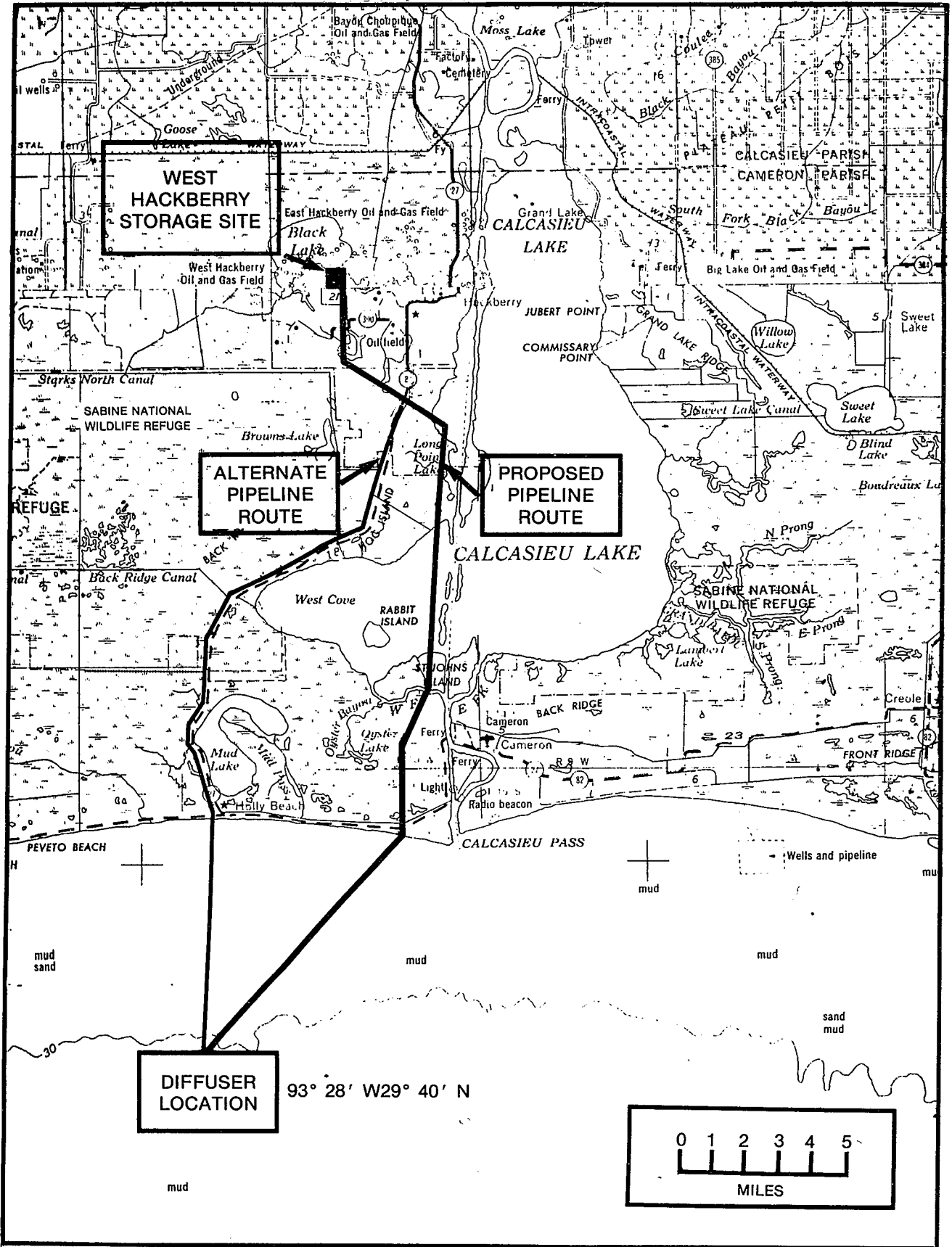

Figure A.4-9 Brine Disposal Pipeline Route

somewhat less than the water injection rate, due to the space created by the enlarging cavern. Brine disposal at this rate would continue over a period of 38 months.

The initial oil fill and subsequent oil refill cycles would produce a nearly saturated brine of about 265 ppt concentration. Oil fill and refill is planned at an average rate of 175,000 barrels/day (200,000 barrels/day maximum) for either the ESR or SPR facilities or both. The brine would be displaced at the same rate over a maximum period of 40 months. The brine leaving the caverns would empty into a 175,000 barrel brine settling and surge pond at the central plant area (see Figure A.4-7). The pond is sized to provide a 4 hour retention time during the maximum brine flow to allow for sufficient surge capacity, some settling, and also for observation of the system to detect any oil mixing with the brine. The brine pumps (7 at 600 hp each) would lift the brine from the pond to transfer it at a pressure of 150 psi through the pipeline to the Gulf of Mexico.

The proposed brine disposal pipeline route to the Gulf of Mexico would leave the central plant area and follow the temporary brine disposal pipeline due south across dry pasture land for 1.7 miles to the ESR brine disposal field. The route would continue south into a flooded area for 0.25 miles before turning in a southeasterly direction for another 0.5 miles across the same flooded area. Continuing southeasterly, it would cross dry land to a shallow bayou, and then pass through marsh and a shallow flooded area for a total of 1.8 miles to Highway 27. On the other side of the highway, the route would cross 1.1 miles of marsh to a portion of Calcasieu Lake lying west of the Calcasieu Ship Channel. It would extend for 0.25 miles into the lake and then turn due south to parallel the ship channel to the Gulf.

Being situated at least 0.5 miles west of the ship channel, the proposed route would continue for another 0.25 miles through the lake and then pass through 2.85 miles of marshland, including 1.6 miles through an area of the Sabine National Wildlife Refuge. It would then be routed 3.6 miles across West Cove of Calcasieu Lake. Another 5.5 miles of marsh would be crossed, including a crossing of Highway 27, before reaching the coastline.

The proposed pipeline would extend in a southwesterly direction for 7 miles along the ocean bottom to the diffuser which would be located in 30 feet of water at $93^{\circ}28' W$ $29^{\circ}40' N$. The total length of this pipeline route is 24.8 miles. See Table A.4-3 for a comparison of the land required for the various land types to be crossed by the route.

An alternate pipeline route is discussed in Section A.4.4.2.2.

Table A.4-3 Land Requirements for Pipeline Routes

		BRINE DISPOSAL PROPOSED	BRINE DISPOSAL ALTERNATE
EXIST. ROADS	M*	0.1	1.0
	P	0.6	6.0
	C	0.9	9.0
DRY LAND	M	2.4	2.65
	P	14.5	16.0
	C	21.8	24.0
WOODED	M		
	P		
MARSH	M	9.5	0.25
	P	57.6	1.5
	C	172.8	4.5
SPOIL BANKS	M		
	P		
	C		
INLAND WATER	M	5.8	17.4
	P	35.2	105.5
	C	105.5	316.5
OFFSHORE	M	7.0	7.0
	P	42.5	42.5
	C	42.5	42.5
TOTAL	M	24.8 miles	28.4 miles
	P	150.4 acres	171.5 acres
	C	343.5 acres	396.5 acres

* - distance in miles

P - area required for permanent right-of-way in acres

C - area required for construction right-of-way in acres

A.4.4.1.5 Oil Distribution System

The oil distribution pipeline between West Hackberry and the Sun Oil Company Terminal at Nederland, Texas, as being constructed for the permanent distribution system for the ESR development at West Hackberry, would also be used for the SPR expansion of the site.

Crude oil supply during fill operations and oil distribution during strategic withdrawal operations would be handled by the Sun Terminal via this 41.5 mile pipeline (see Figure A.4-4). The pipeline would be manifolded into the existing systems at Sun Terminal (see Figure A.4-10), including oil surge tanks and tanker loading systems. An additional dock, surge tanks, and pumping station, however, would be constructed at the terminal to expedite the SPR oil distribution requirements (see Figure A.4-11).

During initial fill operations for the expansion site, oil would be injected into the caverns at a combined rate of 175,000 barrels/day for the 28 months required to fill the 150 mmb facility.

During a national oil supply interruption, SPR oil would be withdrawn over a period of not less than 150 days. Thus the distribution of the total 210 million barrels stored at West Hackberry (60 mmb from ESR and 150 mmb from SPR expansion), would result in a maximum daily delivery rate of 1.4 million barrels to the Sun Terminal. The present plan is to distribute approximately 60 percent of this oil (840,000 barrels/day), by tankers loading at Sun Terminal to the East Coast and Caribbean markets. The remaining 40 percent (560,000 barrels/day), would be transported inland by available pipelines, including the Texoma Pipeline which initiates at the Sun Terminal, and distributed to local refineries.

A total of 5 fill and withdrawal cycles are planned for the life of the facility. During the 4 subsequent refill operations, a fill rate of 175,000 barrels/day over a period of 40 months would be required to regain the combined ESR and SPR 210 million barrel capacity. Although the available storage space would increase during each withdrawal cycle, it has been assumed that only the initial storage capacity would be refilled each time. Subsequent withdrawal cycles would be completed in 150 days at the same 1.4 million barrels/day rate.

A.4.4.1.6 Sun Terminal Description

The Sun Terminal has been in existence for many years. Sun receives crude oil from tankers and barges on the Neches

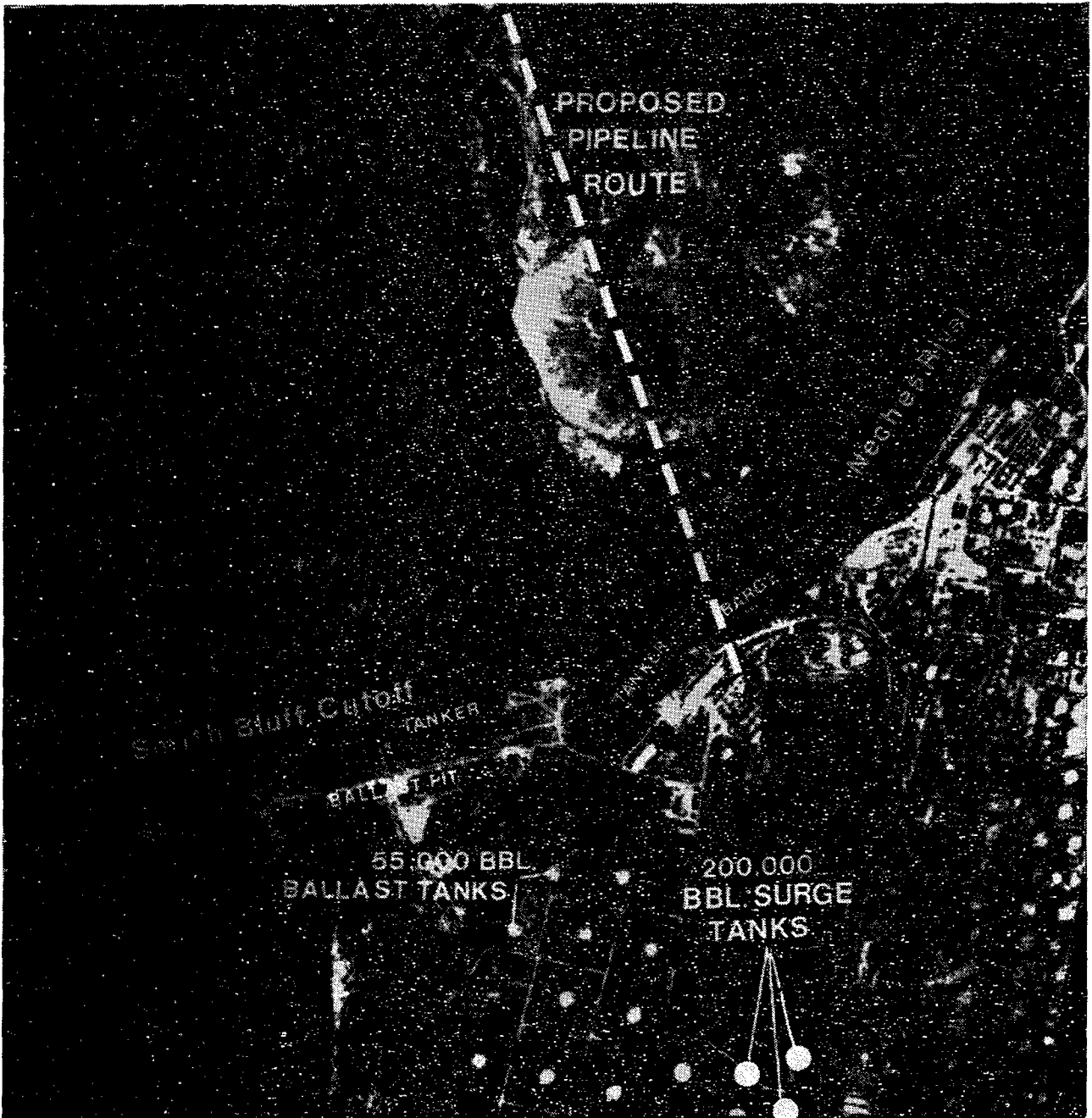

Figure A.4-10 Aerial Photo of Sun Terminal

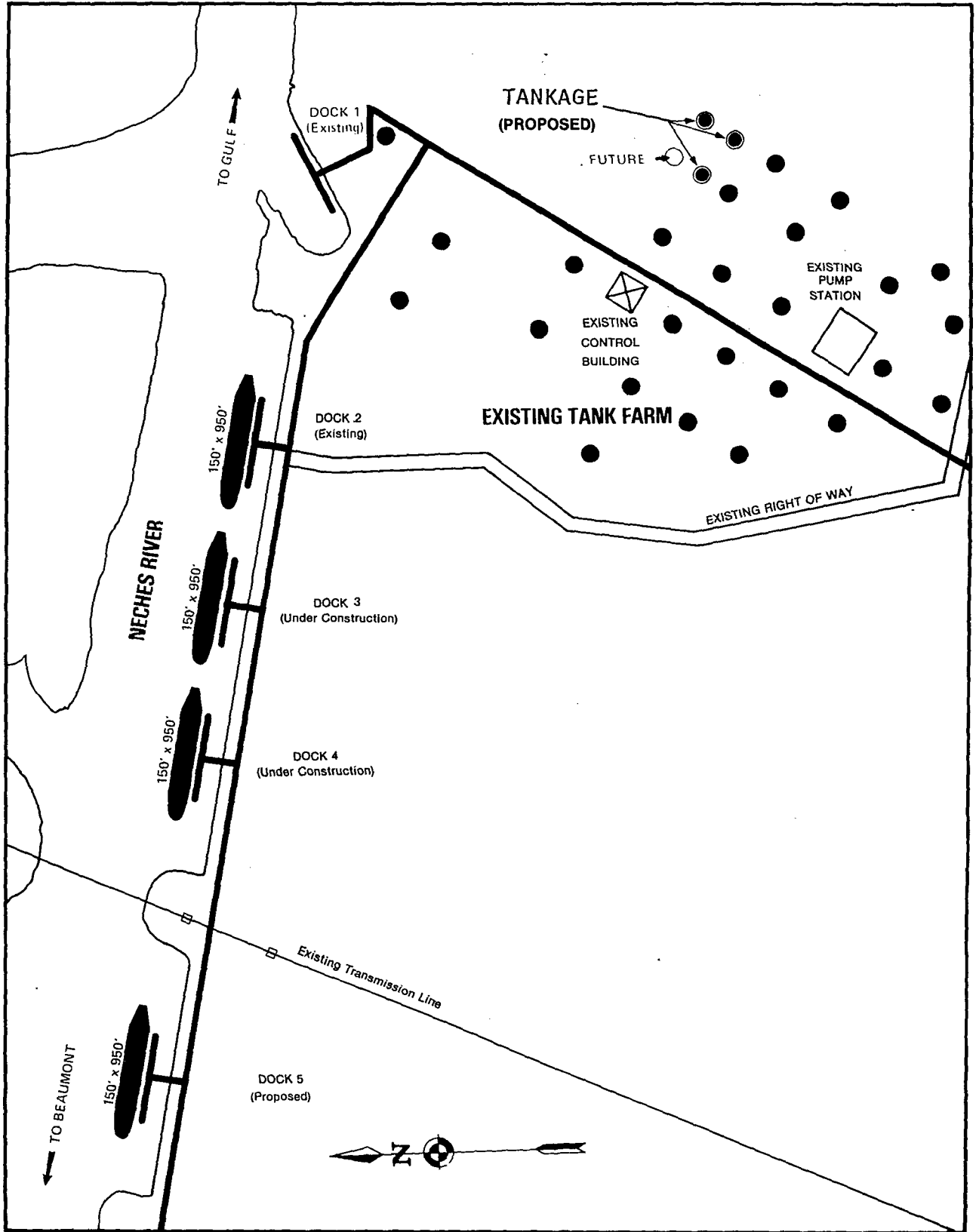

Figure A.4- 11 Sun Terminal Site Plan

River as well as from other small pipelines. They regularly handle oil for the Mobil, Union, Fina, Texaco, and Gulf refineries in the area.

The Texoma Pipeline system which initiates at the Sun Terminal is a 30 inch private pipeline transporting crude oil to the Cushing, Oklahoma area. The Texoma system has an initial throughput forecast of 300,000 barrels per day, approximately 75 percent of which is expected to be supplied from foreign sources. The anticipated system throughput by 1980 is 500,000 barrels per day of which 87 percent would be foreign.

The tanker and barge dock facilities at Sun Terminal are being rapidly expanded. Sun has two tanker docks in operation. Both docks are capable of handling up to 100,000 DWT (dead-weight ton) tankers although current navigational river depths are only 40 feet and tankers of this size cannot be fully loaded. Two docks for handling barges also exist at the terminal with a third scheduled for construction. Barges up to 50,000 barrel capacity can be handled. Sun owns three miles of waterfront property on the Neches and has adequate space for additional tanker and barge docks. Now under construction are two additional tanker docks designed for 130,000 DWT (910,000 bbls) tankers (see Figure A.4-11).

Although Sun Terminal has planned a fifth tanker dock, it is probable that its construction schedule could be accelerated if a commitment is made to transport oil from an expansion of the Texoma Group SPR system through the Nederland facility. Therefore, in order to present a conservative analysis of those activities attributable to the SPR program, an assessment of a new tanker dock is included in this document. The new dock would be similar to docks Nos. 3 and 4 on the Neches River Channel (see Figure A.4-11). The required tanker slip would be about 1200 x 300 x 42 feet (600,000 cubic yards), parallel to the river channel.

The spoil would be deposited in existing designated spoil areas on Sunoco property. Sunoco has two areas, one of 200 acres and one of 400 acres, designated for dredge spoil (personal conversation, J. P. Clubb, Sunoco, March 1977). The area defined for disposal of the dredge material from the construction of a fifth tanker dock would be 130 acres of previously used spoil area on either of the Sunoco disposal areas, and near the transmission line crossing shown on Figure A.4-11.

At the Sun Terminal distribution site, existing crude oil surge facilities and ballast treatment facilities would be available to expedite the onloading and offloading of tankers. Each tanker dock is capable of a 60,000 barrels per hour loading rate. Unloading rates average 15,000 to 20,000 barrels per hour with 40,000 barrels per hour being the maximum experienced. Tanker berth times are expected to range from approximately 12 to 30 hours for loading and 16 to 36 hours for unloading.

Sun currently has 5.3 million barrels of crude oil surge tankage with plans to add more. They own 2,200 acres (part unusable), and have space for a total of 15 million barrels of tankage. Full utilization of their tankage is expected as Texoma pipeline rates increase. It is anticipated that three 200,000 barrel oil surge tanks would be constructed for use in conjunction with the Texoma Group SPR sites (see Figure A.4-11). The required tanks are planned as floating roof structures, commonly used in the oil industry for surge or customs gauging in loading or unloading tankers. They would be approximately 160 feet in diameter and 56 feet in height. All surge tanks at Sun Terminal would be enclosed by retention dikes as required to comply with standard regulations (40 CFR 112.7).

The ballast treatment facility would be available as needed for treating ballast water displaced during tanker loading, for those tankers without segregated ballast holds. The facility consists of two 55,000 barrel ballast water tanks and the associated water cleanup systems capable of treating and discharging water at an average rate of 475 barrels/hr with a maximum oil concentration of 7.5 ppm. The treated water would be discharged into a surface drainage ditch that drains directly into the Neches River. As a standard component of all oil distribution terminals, the capabilities exist for the treatment of rain run-off from the dock areas and oily surface waters taken from minor routine spills around loading and unloading tankers. The potentials for these and major spills are discussed in Appendix C.2.1.2.

The present Neches River navigation channel is 40 feet deep and 400 feet wide. Fully loaded tankers are limited to about 65,000 DWT (450,000 barrels), and light loaded tankers up to 122,000 DWT have been accommodated (personal conversation, H. A. Clubb, March 1977). The Corps of Engineers is now studying a proposal to increase the channel dimensions to 50 feet deep and 500 feet wide. This work may be completed within about 5 years, allowing fully loaded tankers of up to 130,000 DWT to serve the Sun Terminal. For the purpose of

this assessment, however, based on the existing channel depth and the greater availability of smaller tankers, the use of 45,000 DWT (320,000 barrels) tankers would be used for the SPR tanker distribution. Also, light loaded tankers of larger sizes may be used, but the same carrying capacity would be assumed.

Due to the limited size of tankers which can navigate the Neches River channel to the Sun Terminal, a "lightering" operation may be employed for SPR oil supplies coming into the terminal. Lightering is a common oil transport practice by which VLCC tankers (very large crude carriers - 200,000 DWT and up), unload at sea onto smaller tankers which can navigate the harbor channels. For the purposes of analysis, it is assumed that lightering onto 45,000 DWT tankers would be used. The lightering operations would occur from 50 to 100 miles offshore in at least 80 feet of water. The smaller tankers would dock along side the VLCC, and connect by flexible transfer lines. Common rendezvous times would be 12 to 24 hours. The smaller tankers would transport the oil to the Sun Terminal for transfer to the storage site via the proposed pipeline.

During oil fill operations, at a supply rate of 175,000 barrels per day, the resulting tanker traffic would be an average of one tanker per 44 hours. During emergency withdrawal, at a tanker distribution rate of 840,000 barrels/day (60% of total), the resulting tanker traffic into Sun Terminal would be an average of 2 to 3 tankers per 24 hour day.

For the transfer of the oil to the storage site, the following pipeline equipment would be installed at the Sun Terminal. The main pipeline transfer pumps would consist of one 500 hp pump and two 900 hp pumps which would deliver the required 175,000 barrels per day (5100 gallons per minute) to the manifold side of the injection pumps at the storage site. There would be a second 500 hp pump on standby at all times.

For use during subsequent oil withdrawal operations, the following pipeline equipment would be installed at the storage site. Pipeline booster pumps would be used at the site for oil transfer due to the length of the pipeline and the withdrawal time period (150 days). Presently planned are eleven 1500 hp pumps for oil transfer during this operation. These pumps are sufficient to transfer 210 million barrels of crude in 150 days. Equipment included at

both sites would be the necessary meters, control valves, and scraper launching/receiving traps as shown in Figure A.4-12.

Also required at the storage site would be a 20,000 barrel utility oil surge tank and a 3,000 barrel blanket oil tank (Figure A.4-7). The larger tank (approximately 40 feet high and 60 feet in diameter) is needed to divert oil from the pipeline to prevent spills during any injection system malfunction. It would also be used to store oil which would be retrieved from a potential oil spill at the site. The blanket oil tank would be used during the initial leaching of the caverns to protect the cavern ceilings and help control cavern development by maintaining a high pressure oil layer above the brine (as described in Appendix J). The approximate dimensions of this tank would be 20 feet high and 32 feet in diameter.

A.4.4.1.7 Oil Pipeline Description

The oil distribution pipeline between West Hackberry and the Sun Terminal will be constructed using either a 42 inch diameter pipe or a pair of 36 inch diameter pipes depending upon available stock. Construction and use of this pipeline to transport oil for the existing caverns at West Hackberry were assessed in the supplement to the West Hackberry EIS (FES 76/77-4). A brief description of the pipeline is given below for informational purposes.

The pipeline route (Figure A.4-4), will traverse a total of 41.5 miles over varied terrain. The following is a detailed description of the proposed course. The line will leave the central plant area and proceed due west approximately 1.4 miles across the dome, passing through the expansion site (Figure A.4-5), to the southwest end of Black Lake. The route then turns northwest and cross 0.5 miles of Black Lake. After leaving Black Lake, the line will continue in the same direction (NW) through marshland for approximately 5.2 miles to the southern spoil bank of ICW. The route then follows the southern spoil bank of the ICW west to the entrance of the ICW into the Sabine River. At the junction of the ICW and Sabine River, the route pipeline proceeds for 2.1 miles downriver along the eastern bank of the Sabine River, crossing into Cameron Parish in the process. The route then crosses the Sabine River 1.1 river miles north of the entrance of Cow Bayou into the Sabine River, and enters Orange County, Texas.

After crossing the Sabine River, perpendicular to the river, the route traverses a marsh in a northwest direction for approximately 1 mile and then cleared dry land for 1 mile in

A.4-27

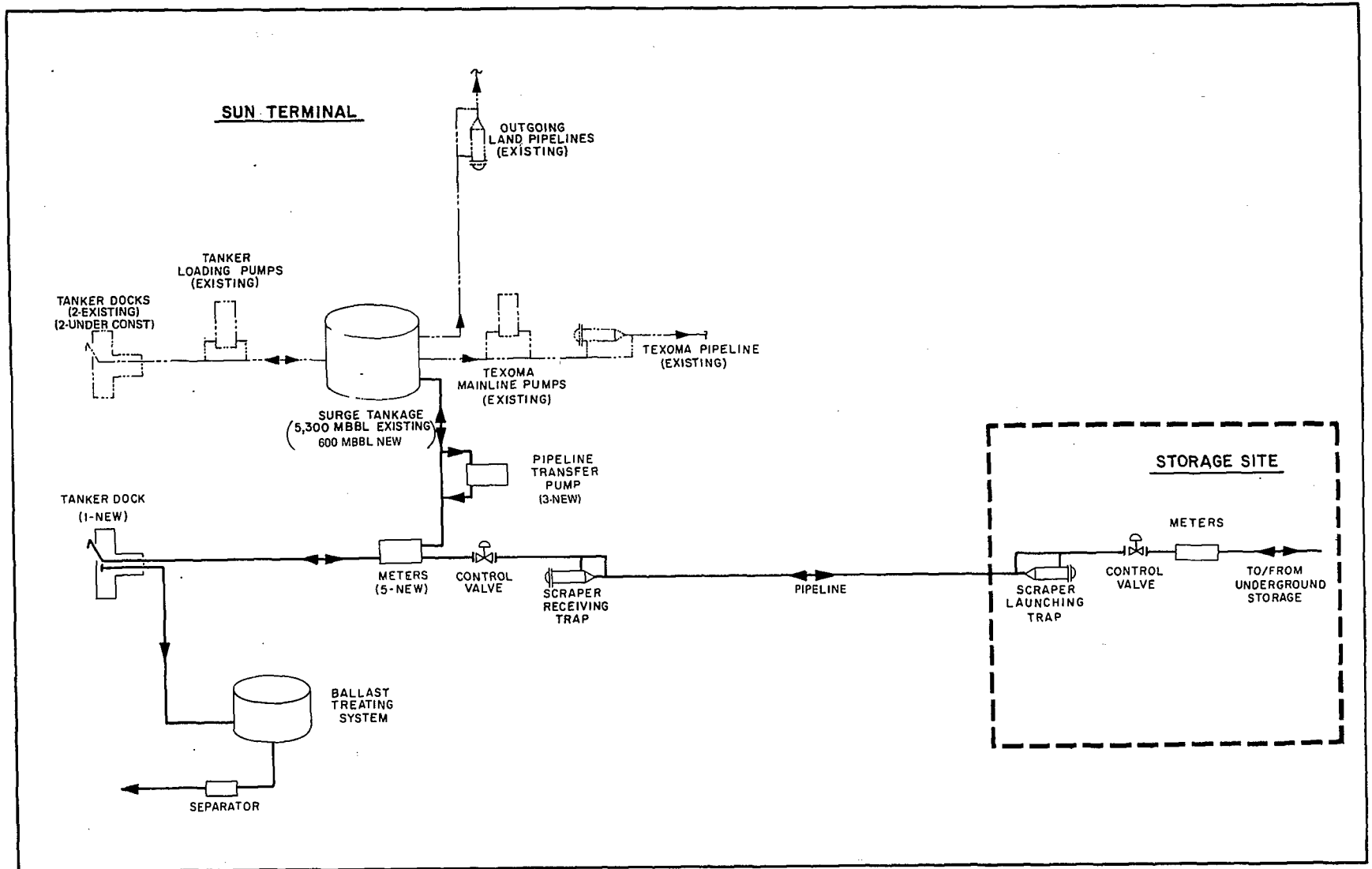

Figure A.4-12 DISTRIBUTION SYSTEM FLOW DIAGRAM

the same direction. The route then swings westward, crossing high marsh, marsh, dry prairie land, gum-oak-cypress groves and a pine forest for approximately 11.25 miles. At this point the route turns southwest, crossing wooded land and marsh for 2.75 miles, and then south for 1.5 miles, thus reaching the Neches River bank. Then the pipeline will cross the Neches River to reach the Sun Terminal. The overall length of the route is 41.5 miles. The distribution pipeline to the Sun Terminal will require a 50-foot wide permanent right-of-way, thus requiring a 242-acre right-of-way. During construction, however, a 75 foot right-of-way would be required on dry land and a 150 foot right-of-way for marshland.

A.4.4.1.8 Land Requirements

About 220 acres of the onsite facilities at West Hackberry and another 210 acres south of the site for brine disposal have been acquired by FEA and are to be developed in the Early Storage Reserve Program. The raw water intake station and the central plant area would be located on this tract. Another 160 acres would be required for the SPR expansion site and would include only the additional storage wells, roadways, and pipeline connections. The proposed brine disposal pipeline to the Gulf of Mexico would require a permanent right-of-way totaling 150 acres. The pipeline construction right-of-way would require 343 acres. In addition to the 682 acres already being developed for the ESR at West Hackberry, new land requirements for the SPR expansion would total 310 acres for onsite expansion and additional right-of-way acquisition. Thus, a total of 992 acres would be permanently committed for the development of the combined West Hackberry ESR and SPR facilities and pipeline rights-of-way.

A.4.4.2 Alternative Physical Facilities

The feasibility of several alternative systems components were considered in the West Hackberry SPR expansion program.

A.4.4.2.1 Raw Water Supply

Three possible alternative surface water sources were considered in lieu of the planned utilization of the raw water intake station on the Intracoastal Waterway. Since it is planned to construct a brine disposal line to the Gulf, the option of building a parallel water supply line was suggested. This pipeline would cost approximately \$14 million to construct. Also required would be a remote pumping station on an offshore platform. Such platforms typically cost about \$1.6 million. An intake structure on the ICW and an onsite supply pipeline, on the other hand, will be completed for the ESR development at West Hackberry for \$7,097,000, and would be adapted for SPR use at a fraction of the cost. Extensive multiple screening would be required at the offshore intake

to minimize entrainment of organisms, and technical problems with biological fouling of the pipeline would exist for a very long pipeline.

An alternate water supply intake location on Black Lake would be economically desirable, but would pose a potential threat to the rich biological productivity of the lake. The total cost of placement of the intake structure on Black Lake would be \$1,566,000, which is significantly lower than other alternatives. However, during the withdrawal of water from the lake, changes in water depth, salinities and increased levels of pollutants could adversely affect the high populations of shrimp and game fish which mature in the lake. Entrainment of immature shrimp and fish could pose a serious problem during the less mobile phases of their life cycle.

The other possible source for water supply would be the Calcasieu Ship Channel, 5.5 miles southeast of the site. A pump station (requiring 2 or 3 acres), would be constructed adjacent to the channel on land built up from former spoil areas. Power supply from local utilities would be available at the site. Dredging of approximately 230,000 cubic yards of bottom material from the sides of the ship channel would be required for an intake sump. This would allow water to be taken from the deeper more saline portions of the channel, thus minimizing adverse biological impacts. A saline wedge, or a stratification of the denser saline water from the sea under the lighter brackish surface water, is typical of the Calcasieu Ship Channel. Most of the migratory organisms which use the channel would be found only near the surface, and since the deeper parts of the channel are well below the light penetration depths, it is not likely that there would be any significant life forms adversely affected by withdrawing water from the deeper portions of the channel. The connecting 5.5 mile supply pipeline to the site would follow the same route as described for the proposed brine disposal pipeline route which would parallel the ship channel to the Gulf Coast (see Figure A.4-8).

The possibility of drilling a series of wells into saline aquifers was also considered. Due to the size of the required yield (approximately 42,000 gpm maximum), and based on an estimated per well yield rate of 1000 gpm, the expanded West Hackberry facility would require a 42-well system. For purposes of comparison, the principal user of this source in the area is the town of Hackberry which has two wells providing a combined average of 140 gallons per minute (gpm). Also the city of Sulphur, 15 miles away, uses 5 wells which yield a combined average of 560 gpm. Based on a cost per well of \$150,000 for a total of \$6.3 million, when compared to the cost of adapting the ESR supply system, the cost of constructing a deep aquifer well system at West Hackberry would be prohibitive.

A.4.4.2.2 Brine Disposal

As an alternative to the proposed brine disposal pipeline which parallels the Calcasieu Ship Channel, the pipeline could be routed along the western edge of Highway 27 to the Gulf of Mexico (see Figure A.4-9). This route is 3.6 miles longer than the proposed route. Whereas a majority of the proposed route would be in open marsh and open water of Calcasieu Lake, the alternate route would follow Starks Canal along the western side of the highway for a majority of the distance, including 9.6 miles through the Sabine National Wildlife Refuge. The diffuser would be located 7.0 miles offshore in the same location as planned for the proposed route.

From the storage site area, the first 4.25 miles south and then southeast to Highway 27 would follow the same route as discussed for the proposed pipeline route (see Section A.4.4.1.4). Proceeding south along the western side of the highway, the route would cross 1.0 mile of dry land before entering Starks Canal. After following Starks Canal for 15.9 miles through the Refuge and on past the western margin of Mud Lake, a 0.25 mile segment at Holly Beach would complete the route across the coastline Highway 82 to the Gulf.

The pipeline would extend in a southerly direction for another 7.0 miles along the ocean bottom to the diffuser location which lies in 30 feet of water (see Figure A.4-9). The total length of this alternative pipeline route is 28.4 miles. See Table A.4-3 for a comparison of the land required for the various land types crossed by the two routes.

As an alternative to a brine pipeline to the Gulf of Mexico, a deep well injection system could be built. Included in the engineering design for the ESR development at West Hackberry is an 11-well system designed to handle 11,800 gpm for disposal. It would require about 36 acres of land for its construction. An expanded system to accommodate a maximum flow rate of 30,000 gpm during additional leaching for the SPR expansion facility would require about 19 extra wells, and about twice as much land would be permanently committed. The total cost of an expanded injection system, however, would be less than that of a pipeline to the sea. Based on a cost of \$660,000 per well and excluding land costs, the expanded injection system would cost \$12.5 million as opposed to \$28 million for the pipeline.

In the preliminary analysis of the ESR injection system (FES 76/77-4, Jan. 1977), it was shown that after 5 cycles of brine injection, aquifer pressure would build from 3000 psig to 3450 psig - well under the estimated fracture pressure of 4500 psig. An expanded system at West Hackberry, however, would inject brine at 3 times the rate calculated for the ESR program. Consequently the aquifer would be subjected to much greater pressures. If brine injection is to be seriously considered for brine disposal for the expansion program at West Hackberry, then a complete pressure analysis will be conducted to determine the engineering feasibility of this plan and the likelihood of the aquifer fracturing.

A.4.4.2.3 Distribution

The distribution pipeline to the Sun Terminal at Nederland, which is planned for construction under the ESR development at West Hackberry, would also be used for the SPR development. Several oil distribution alternatives were evaluated for the West Hackberry ESR facility (FES 76/77-4). These alternatives were either dismissed as being unsuitable or were shown to be inferior to the Sun Terminal option because of environmental, economic, or distributional considerations. Since these alternatives have been addressed in the West Hackberry final EIS (FES 76/77-4), they are not addressed in this document.

A.4.5 Construction Techniques

A.4.5.1 Road Construction and Other Grading

The western half of West Hackberry dome is situated on dry ground ranging in elevation from 2 to 21 feet. The proposed SPR expansion area would be located on the highest portion of this mound, south of Black Lake (see Figure A.4-3). Thus, roads, wells, and buildings would be situated on higher ground. Approximately 1.8 miles of permanent access roadways would be needed. Construction would require a minimum of clearing or grading and would require only gravel or shell surfacing.

Additional road construction for SPR expansion of the site would be minimal and related primarily to the construction of the brine disposal pipeline. Temporary construction roads would be required for certain Sections of the proposed offsite pipeline (see Section A.4.5.2).

No additional grading or landfill areas would be required during the construction of the main storage site. Surge ponds and buildings would be completed in the ESR development at West Hackberry. The impact of their construction is assessed in the Early Storage Reserve EIS (FES 76/77-4, January 1977). The raw water intake sump would also be completed for the ESR and would require approximately 7000 cubic yards of dredge from Black Lake. The spoil would be deposited on an adjacent dry land area of the site.

A.4.5.2 Pipeline Construction Techniques

Three basic methods of construction may be used during construction of the offsite pipelines: (1) flotation canal method, (2) push ditch method, and (3) conventional dry land method.

The flotation canals or barge-lay method of construction is required in the marsh portions of a pipeline route where the ground cannot support heavy construction equipment or in open waters and passes of Calcasieu Lake. Therefore, the work must be done on construction barges operating in navigable water or a canal. Barge-lay techniques would be required for portions of the proposed brine pipeline route along the Calcasieu Ship Channel. Most of this alternative route would pass through open waters and coves of the Calcasieu Lake (see Table A.4-3).

The push ditch method of construction would be used in the boggy portions of the pipeline route where the ground can support marsh buggy mounted excavating and backfilling equipment, but cannot support conventional dry land pipeline construction equipment. Most of the marshland pipelines in this area are constructed using this technique.

Conventional construction would be used through the dry land portions of the route where heavy construction equipment can be supported. A 2.5 mile segment of the proposed brine pipeline route would allow conventional dry land techniques (see Table A.4-3). All buried portions of the pipelines would be externally covered with an epoxy coating as a physical barrier between the pipe and environment. Brine pipelines would also be epoxy lined with thin film fusion bonded epoxy. Sealed casings would be required at highway or railway crossings.

A.4.6 Development Timetable

As currently planned, the development of the ESR facility at West Hackberry and the SPR expansion would be timed such that the phases for development of the two projects would run in succession. The site development and facility construction for the expansion would begin directly after the site preparation and facility construction of the ESR, while the ESR caverns are being filled with oil. According to present proposals, construction of the site facilities, pipelines, and external facilities would be accomplished during the first 5 month of development. Three drill rigs working simultaneously would drill the storage wells over a period of 18 months. After the first group of wells are completed, however, they would be connected to the system (month 4) so that initial leaching could begin. After 38 months of initial leaching, the first of cavity wells would be available to begin the oil fill process (see Table A.4-4). The initial oil fill process would take a total of 28 months to fill the 150 mmb expansion facility.

A.4.7 Operation

The operating procedures required for the SPR facilities are discussed in this section. Most of the information would apply to either the proposed West Hackberry expansion site, or one of the alternative storage sites. Differences in the following are discussed in Sections A.5.7, A.6.7, and A.7.7.

A.4.7.1 Storage Phase

When the storage facility has been completed and design capacity is reached, there would be an interim period during which the only activities at the site would be security and maintenance checks. However, readiness for activation during an emergency requires keeping operations personnel available.

It is possible that certain national emergencies could occur before the planned total reserve capacity of the SPR is met. In order to prepare for such a contingency, the facility design provides for oil return bypass valves to allow intermittent recovery of already stored oil.

During this static storage period, all equipment would be serviced and tested on a regular basis to ensure proper working order. Pumps, pressure valves, and safety equipment would be normally lubricated and operated at least once a month. Personnel would be on duty on a 24-hour basis.

Table A.4-4 Timetable for Construction and Fill

<u>Month Period</u>	<u>Fill Rate (MB/D)</u>	<u>No. of Months</u>	<u>Cum. Storage (MMB)</u>	<u>Phase of Development</u>
West Hackberry - Early Storage Reserve				
0-3.5	0	3.5	0	Site preparation
3.5-6	80	2.5	6	Interim fill from Amoco Dock
6-16	175	10.0	60	Pipeline to Sun Terminal. Complete final fill.
West Hackberry - SPR Expansion				
7-12	0	5	60	Site preparation
8-26	0	18	60	Drill and complete 15 wells
12-50	0	38	60	Initial leaching
50-78	175	28	210	Initial fill

A.4.7.2 Extraction Phase

The ESR and SPR program requirements plan for an emergency withdrawal of stored oil over a period of not less than 5 months. Thus, the maximum delivery rate for a 210 million barrel facility at West Hackberry would be 1.4 million barrels per day. The facility's systems are designed to handle this maximum capacity.

Crude oil stored in each salt cavity would be recovered by pumping raw water into the bottom of the cavity, thus displacing the oil through the concentric tubing at the top of the cavity. The oil would leave each wellhead at 150 psi. Because of the length of pipeline to the distribution facility (41.5 miles), booster pumps would be necessary for transfer to the terminal.

The Sun Terminal at Nederland, Texas would handle all of the oil from the West Hackberry SPR site. The present plan is that about 40 percent of the emergency supplies (560,000 barrels/day) would be transferred by inland pipelines to local and regional refineries and to midwestern states through the Texoma pipeline system which originates here. The remainder would be reloaded onto tankers for shipment to the East Coast and Caribbean refineries.

A.4.7.3 Refill Phase

After an oil supply interruption has ended, refill of the SPR storage facility is planned. The rate of fill would depend on the availability of crude; but is currently planned for fill over a 40 month period at a rate of 175,000 barrels/day.

The refill process is the reverse of the recovery process. The crude oil is injected into the top of the storage cavity, thus displacing the brine, which in turn goes to the disposal system.

Five fill and withdrawal cycles are designed for the ESR and SPR. Although for leached cavity facilities the cavern capacity enlarges during each cycle due to the introduction of fresh water, only the original design capacity for each cavity would be refilled. The fact that a smaller percentage of fresh water would be introduced into the cavern during successive fill operations reduces somewhat the continued leaching process. The cavern size would increase about 77 percent after 4 refill cycles, leaving a minimum of 200 feet of salt separating the caverns. Thus there is no indication that the integrity of the caverns would be adversely affected.

A.4.8 Termination and Abandonment

When the nation has developed sufficient independence from foreign oil suppliers, the oil storage capacity at West Hackberry would no longer be needed. DOE operations would be terminated and the facility disposed of or abandoned.

At present, it is intended to put the facility to some beneficial use, rather than seal it off with concrete. Beneficial uses might include disposal of dredge spoil or wastes such as slurried fly ash or other polluted or toxic materials. Another possibility is to develop a compressed air storage facility for peak power use. The final selection of a termination plan would likely depend on the economic and environmental tradeoffs and regulations that are in effect at the time of termination.

A.5 ALTERNATIVE STORAGE SITE - BLACK BAYOU

The development of Black Bayou for the SPR program is considered as an alternative to the proposed expansion of the West Hackberry ESR facility described in Section A.4. As currently designed, the facility would satisfy 150 million barrels of the SPR crude oil storage requirements in the Texoma/Lake Charles/Beaumont storage region.

A.5.1 Location

Black Bayou salt dome is located in northwestern Cameron Parish of southwestern Louisiana, and is approximately 8 miles southeast of Orange, Texas, and 12 miles south of Vinton, Louisiana. The Gulf of Mexico is 19 miles south of the dome and the Intracoastal Waterway (ICW) is two miles to the north. The site is 12 miles west of the West Hackberry dome (see Figure A.5-1).

There are no primary roads in the near vicinity since the area is covered by marsh. Vehicular access to the dome is from Vinton via a paved road to the ICW, and across the ICW on a ferry to Cameron Farms, 5 miles east of the site. Access from Cameron Farms is along a shell road which parallels Bancroft Canal to the dome and a network of built-up service roads.

The dome underlies a marsh that is crisscrossed by a canal and bayou network. Black Bayou is a large bayou extending from Sabine Lake and is connected to the ICW due north from the dome by Black Bayou Cutoff Canal.

All the surface and minerals embraced by the dome limits are owned by Amoco Production Company, as successor to Stanolind Oil and Gas. There has been some activity by Freeport Sulphur Company. However, no lease or contract from Amoco and its predecessors has been recorded. The minerals over the dome are referred to as the J. B. Watkins tract, although J. B. Watkins is completely out of the current title as to both surface and mineral rights. However, there is no oil or gas production or storage activities over the top of the dome in the area proposed for the SPR facility.

The site is well situated for distribution of oil by connection to the proposed ESR pipeline from West Hackberry to the Texoma facilities at Nederland, Texas, some 20 miles west of Black Bayou dome. From the Nederland facilities,

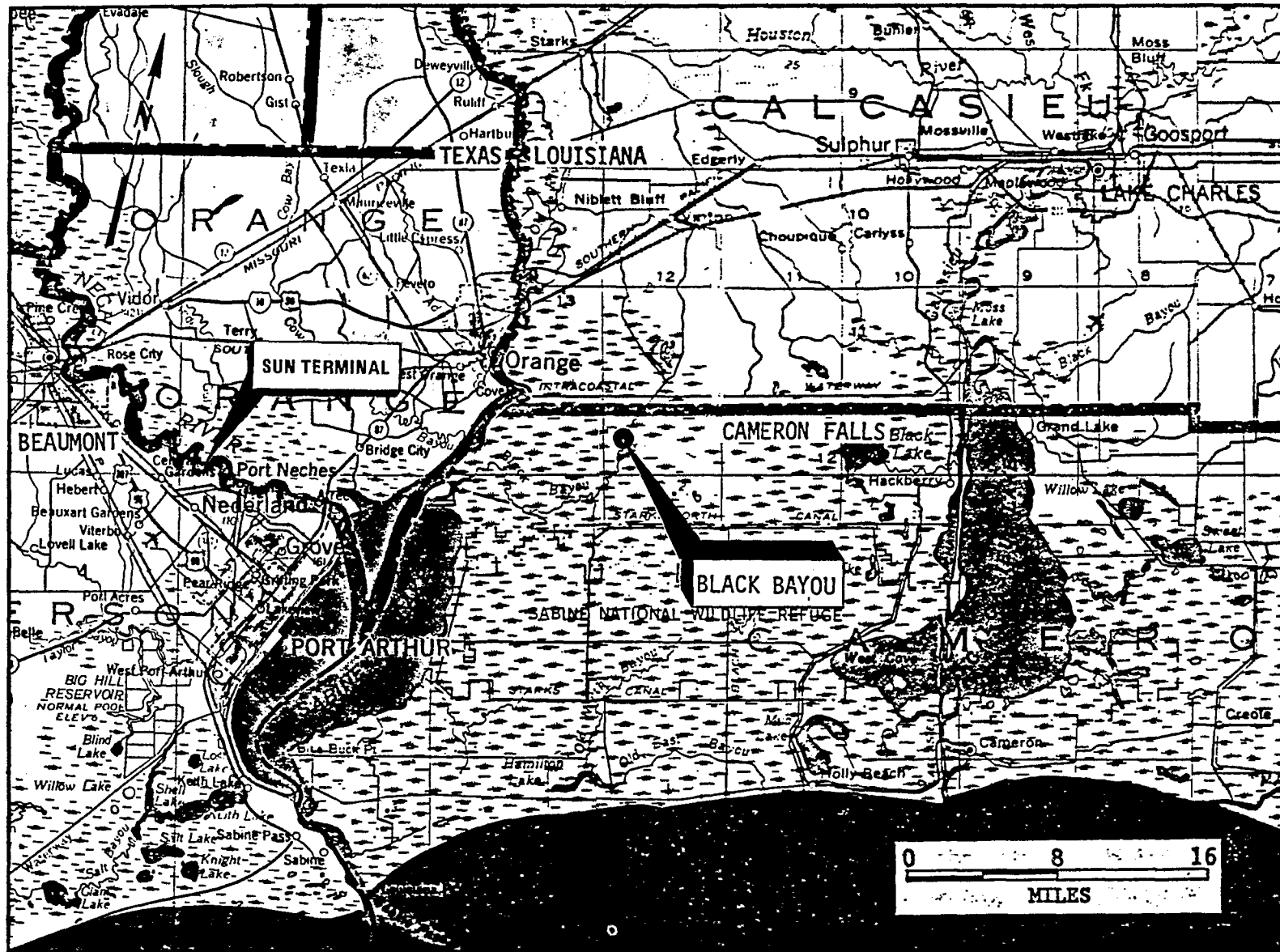

Figure A.5-1 Location Map - Black Bayou Dome

the stored oil can be moved to local and regional refineries via inland pipelines including the Texoma Pipeline, or loaded onto tankers for delivery to East Coast and Caribbean refineries.

Other than the proposed means of distribution, local refineries could be connected to the site by new and existing pipelines. Black Bayou is located within about 50 miles of eight major area refineries. Table A.5-1 lists these refineries.

A.5.2 Capacity

Total storage capacity for the Black Bayou site is proposed as 150 million barrels. A total of 15 solution caverns would be constructed to accommodate this capacity. Individual cavern size is set at 10 million barrels initially, with ultimate capacity of about 20 million barrels after five cycles of oil fill and withdrawal.

All caverns, due to increased leaching caused by fresh water injected during withdrawal cycles, would increase in diameter from 275 ft in diameter to about 400 ft in diameter after five cycles. The 1000 ft height of each cavern would be maintained. This larger ultimate cavern diameter must be used to determine spacing in order that sufficient wall thickness is maintained between caverns once the caverns have reached maximum size. The wells would be spaced on 600 foot centers and the peripheral wells would be located at least 400 feet from the dome edge to assure a 200 foot wall around every cavern.

About 230 acres of surface area would be required to contain these caverns at their ultimate capacities. The area selected for construction would be in the eastern portion of the dome since this would minimize interference with the existing waterways and bayous that overlie the dome. If it is necessary to increase Black Bayou storage beyond the 150 million barrel point, salt extent would not be a limiting factor. The dome is fairly large, consisting of approximately 800 acres when measured at the -2,500 foot salt contour, which is sufficient to construct about 30 additional 10 million barrel caverns. If all the dome area was to be used, total storage volume could reach 400 million barrels.

A.5.3 General Systems Description

The presently proposed development of Black Bayou as an alternative site would involve a relatively irregular placement of wells on platforms over the marsh on the eastern

Table A.5-1 Beaumont/Port Arthur/Lake Charles Refineries

<u>Company - Location</u>	<u>Capacity (BPD)</u>	<u>Distance (mi) from Black Bayou</u>
Cities Service - Lake Charles	268,000	22
Conoco - Lake Charles	83,000	26
American Petrofina - Port Arthur	26,000	24
Gulf - Port Arthur	312,100	24
Mobil - Beaumont	325,000	35
Texaco - Port Arthur	406,000	24
Texaco - Port Neches	47,000	18
Union - Nederland	127,000	20

half of the salt dome. The wells would be drilled from barge mounted rigs using existing and new canals for access (see Figure A.5-2). To create the new caverns requires pumping freshwater through the wells into the salt and displacing the resulting brine out through concentric well tubings (See Appendix J).

The central plant, including pumps, surge ponds, and surface tanks, would be located adjacent to the access road at the southeast corner of the storage site (see Figure A.5-2). An area of approximately 10 acres would be landfilled so that the central plant and equipment yard could be located on dry land.

As currently proposed, the raw water intake station would be located on the Black Bayou channel (see Figure A.5-2). Brine disposal would be by pipeline to the Gulf of Mexico for direct disposal offshore. The proposed route for this pipeline is discussed in Section A.5.4.1.5.

Oil distribution to and from the site would be by constructing a short pipeline connection along Black Bayou Cutoff to the ESR pipeline being constructed between West Hackberry and the Sun Terminal at Nederland, Texas (see Figure A.5-3). The initial filling of the caverns is planned as a separate operational phase after the cavern leaching process has been completed for the 15 storage wells.

A.5.4 Site Development

A.5.4.1 Proposed Physical Facilities

A.5.4.1.1 Site Layout

The 15 storage wells would be located on elevated platforms (30 x 30 ft.) spaced roughly on 600 ft. centers over the marsh on the eastern half of the salt dome. New access canals would be required to construct and maintain the 15 wells as shown in Figure A.5-2. Approximately 6400 x 65 x 8 ft. (125,000 cubic yards) of spoil material would be dredged. A dredge spoil area of approximately 15 acres would be needed. The Corps of Engineers has designated spoil disposal grounds in the Black Bayou area. The U. S. Fisheries and Wildlife Service, Field Supervision, also must approve dredging permits for the site. Both departments have been contacted and would recommend to DOE suitable disposal grounds for this work.

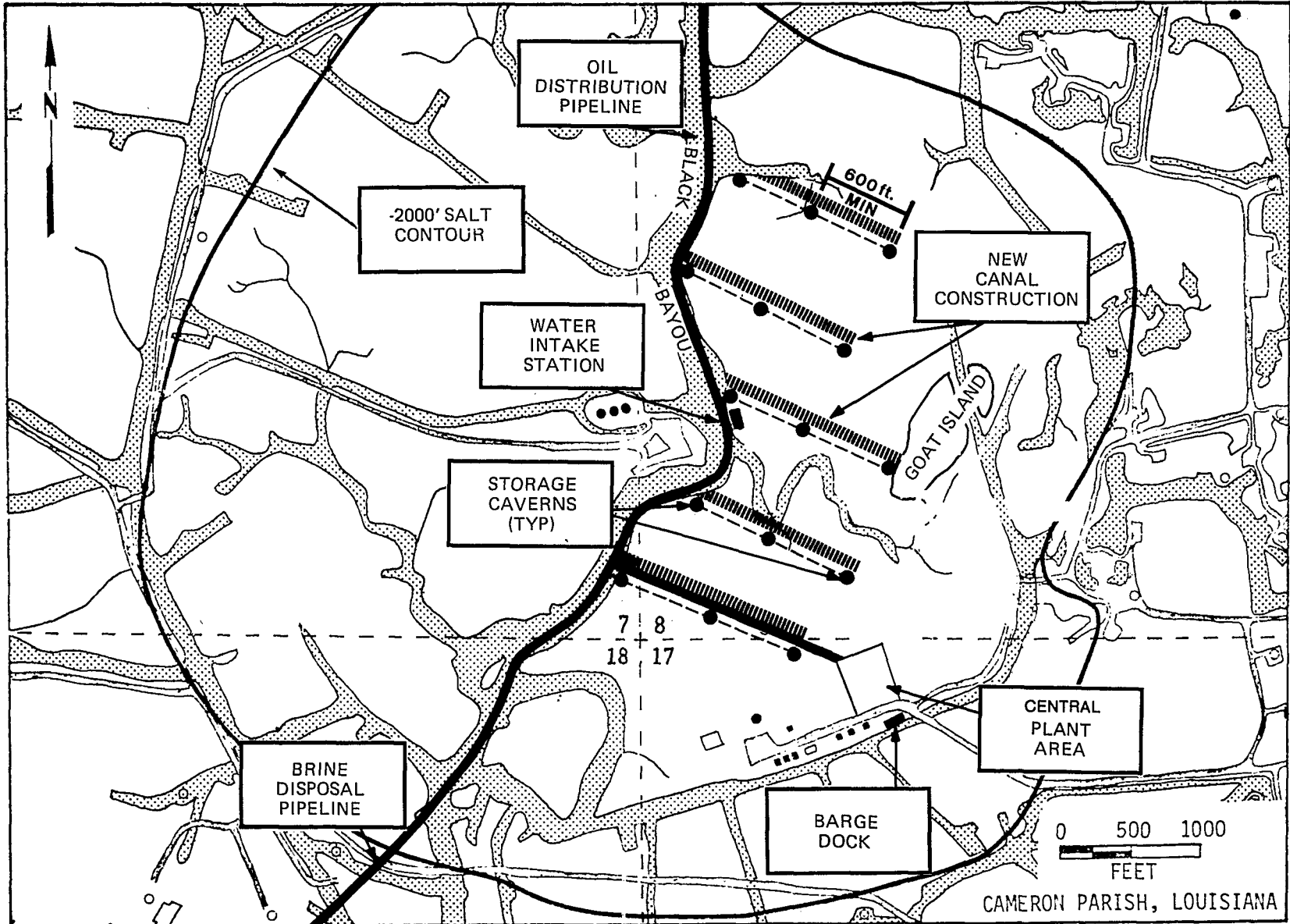

Figure A.5-2 Site Development - Black Bayou

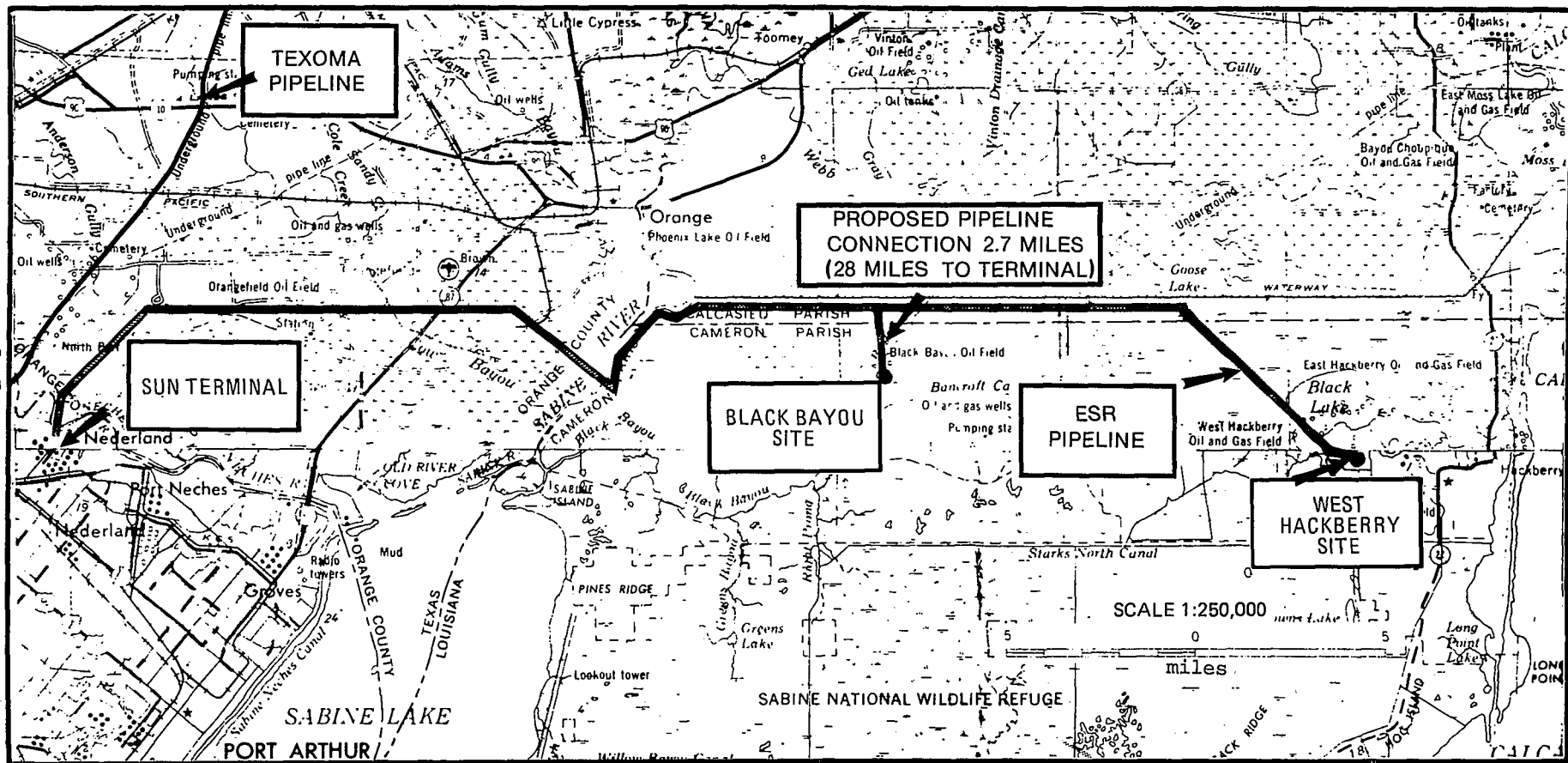

Figure A.5-3 Oil Distribution Pipeline Route

Because wells must be accessed by barge, for construction and workover, a small equipment barge dock would be included in the facility design. A timber dock with mooring piles (see Figure A.5-4), would be constructed on the canal just south and across the road from the central plant area (see Figure A.5-2).

A barge slip (260 x 50 x 8 ft.) would be required parallel to the canal. The dredge spoil would be deposited on dryland adjacent to the barge slip.

No new roadways would be required. Vehicular access would be to the central plant facility only. Pipelines connecting the wells and the central plant would be buried in the marsh along the access canals. A pipeline flow diagram for the Black Bayou facility is shown in Figure A.5-5.

A.5.4.1.2 Central Plant Facilities

The central plant as currently designed would include all pumps, pump structures, control buildings, office, surge ponds, surface tankage, metering systems and transformers (see Figure A.5-6). The plant site, about 10 acres, would be constructed upon landfill. All buildings and permanent structures would be supported on concrete piles for stability.

Also adjacent to the central plant would be an equipment yard of several acres. A security fence would enclose the entire plant site and equipment yard.

Buildings would be required to house the main office, all electrical control equipment, a repair shop, and a chemical lab. At this lab, brine samples would be analyzed to calculate the rate of new leaching. Also, tests would be conducted on crude oil samples to determine their compatibility with other stored oils. Buildings would be of standard steel construction and would be built upon concrete slabs. Reinforced concrete piles would support beams upon which the floor would be laid.

The various pumps required for leaching, oil injection, brine disposal, and pipeline operation would be located in a pump building or other appropriate sound attenuating structure. A list of the required pumps is given in Table A.5-2. As shown, standby pumps are provided to insure steady operation. Power for the electric pumps and equipment would be supplied by local utilities.

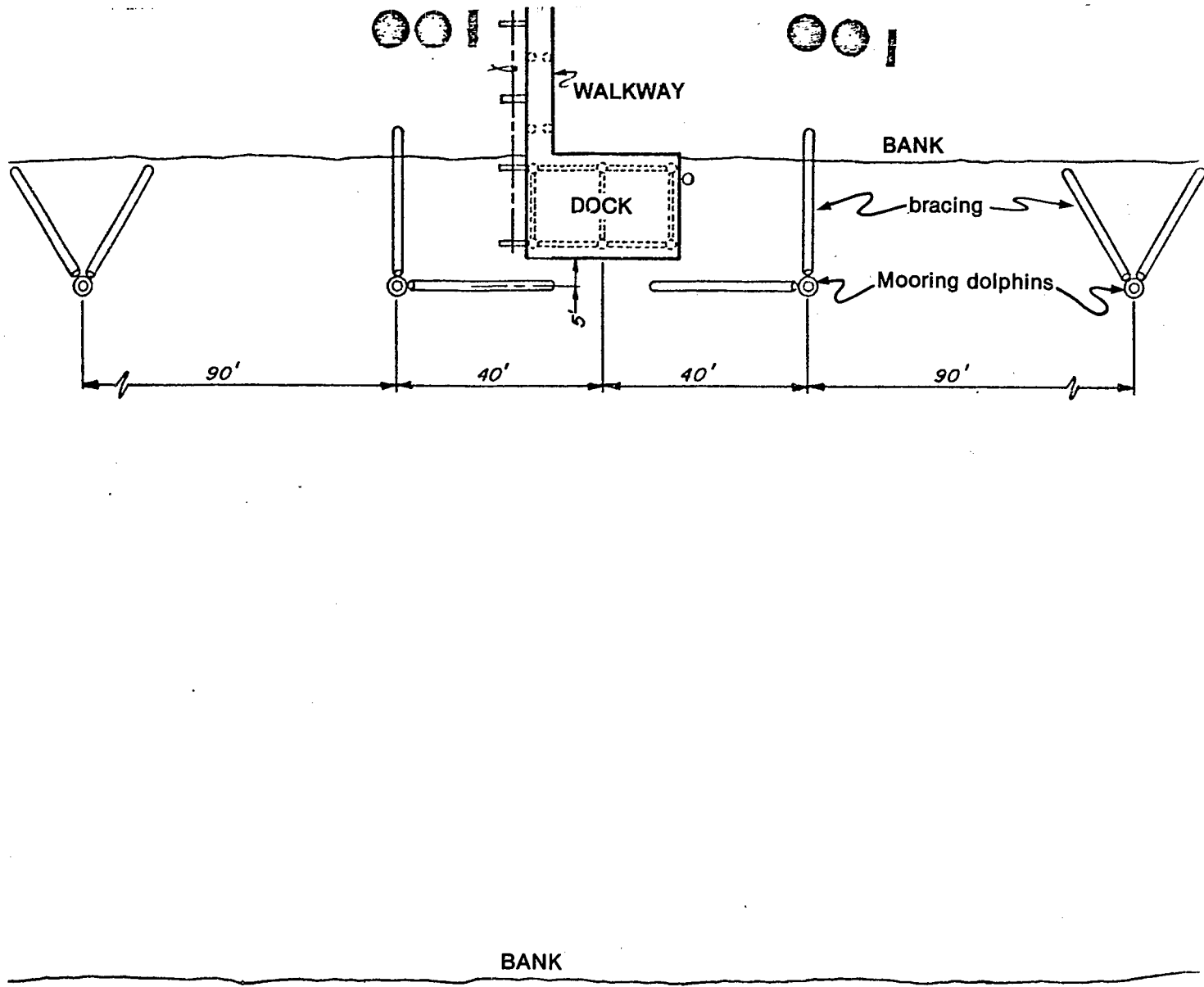

A.5-9

Figure A.5-4 PRELIMINARY PLAN OF BARGE DOCK

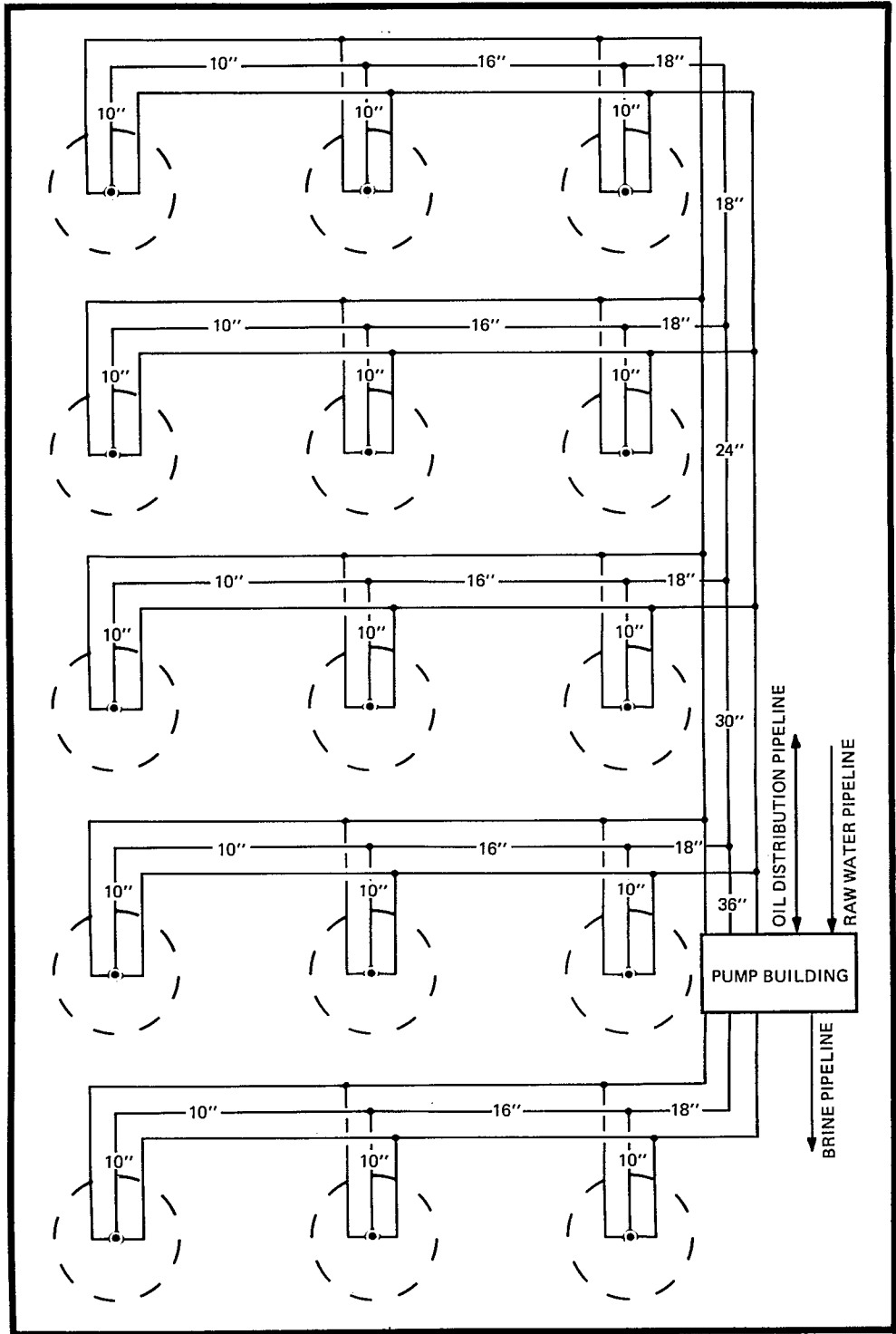

Figure A.5-5 Pipeline Flow Diagram

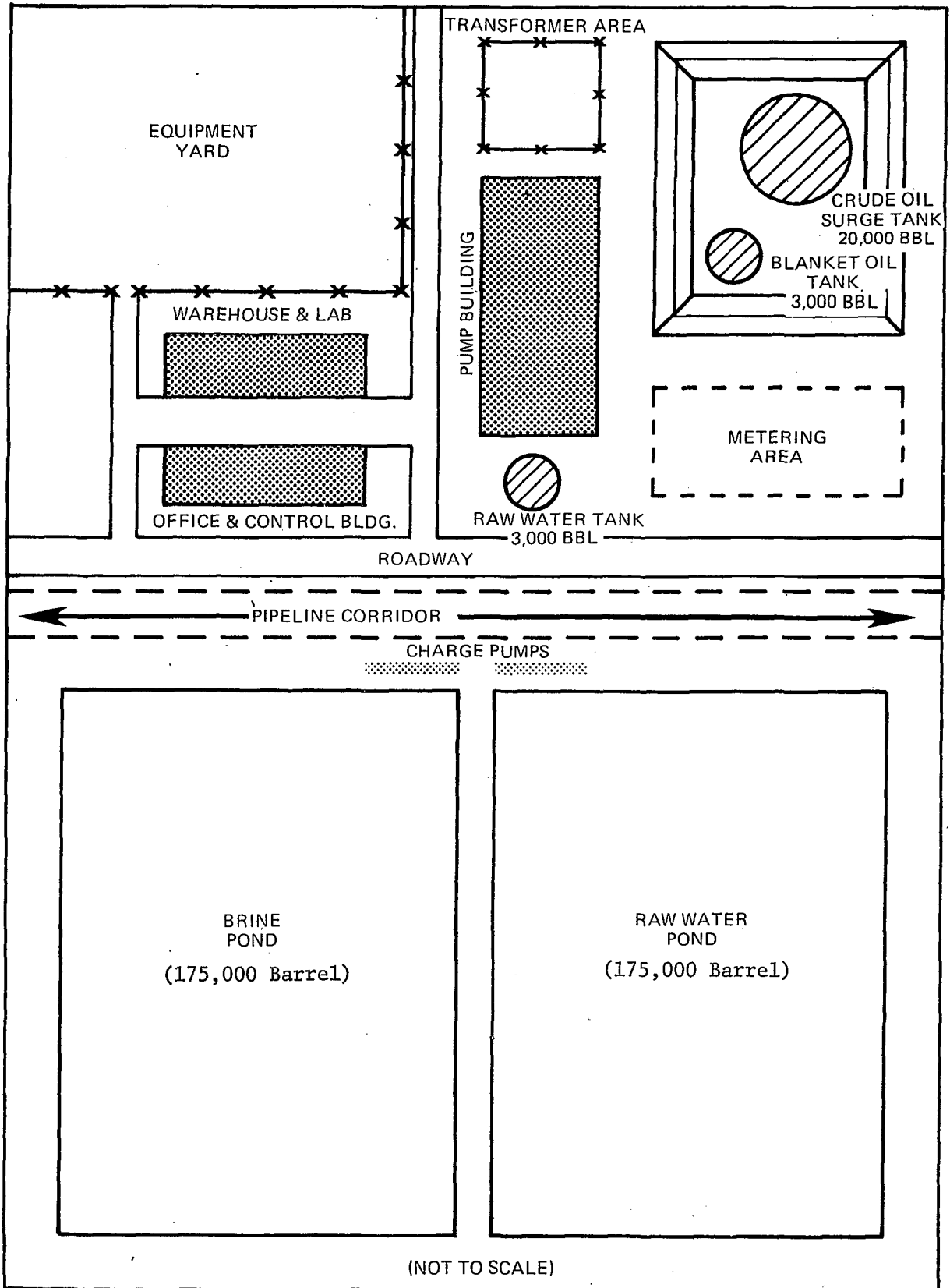

Figure A.5-6 Central Plant- Preliminary Layout

Table A.5-2 Pump Requirements - Black Bayou

Pump Task	Quantity	Horse-power	Discharge Pressure (psi)	Total Design Flow Rate (barrels/day)
Water Supply	4 1 Stand-by	400	45	1,050,000
Water Booster	7 1 Stand-by	900	255	1,050,000
Brine Disposal (Water Booster during Displ.)	7 (1 Stand-by) 8	600 600	150 260	1,010,000 1,050,000
Water Injection	8 2 Stand-by	1500 1500	718	1,050,000
Oil Transfer (Injection)	8 1 (1 Stand-by)	1500 1500	756 800	1,000,000 175,000
Blanket Oil	1	100	1000	3,500
Oil Transfer at Terminal	2 1 1 Stand-by	900 500 500	600	175,000
Tanker Load	2	1500	100	600,000

A.5-12

Also indicated in Figure A.5-6 are tanks and ponds as needed for operation and construction (described in later sections). In the case of all oil tankage, retention dikes are planned as required for oil spill containment (40 CFR 112.7). Dike enclosures are a standard engineering practice for compliance with these regulations.

The entire site area is overlain with low-lying marsh of from 0 to less than 5 feet in elevation with the exception of service roads and well pads which have been constructed in the area. In order to raise the plant area and equipment yard above the 100 year hurricane flood level, approximately 6 to 8 feet of fill would be required. Thus for 10 acres of landfill, and accounting for the surge ponds and oil spill containment areas, an estimated 91,000 cubic yards of fill material must be obtained.

A.5.4.1.3 Raw Water System

A water intake station would be constructed on the eastern side of the Black Bayou channel (see Figure A.5-2). The intake structure would consist of a platform (10' x 10') supported on pilings with multiple screens for minimizing impingement of organisms. A sump would be dredged from the side of the channel to minimize inflow restrictions and sand or mud entrainment. Approximately 150 cubic yards would be dredged and then deposited in the designated disposal area.

A 36 inch pipeline connection of about 3,500 feet would be laid parallel to other onsite piping to the central plant and into the 175,000 barrel raw water surge pond (see Figure A.5-6). The booster pumps (7 at 900 hp each), would supply the manifold side of the water injection pumps (8 at 1500 hp each). The water would be injected into the caverns at a 718 psi head pressure. The 3,000 barrel water tank located on site would be used for start-up operations only.

During the initial leaching operations, the design water flow rate would be 2,000 gpm (68,600 barrels/day) per 10 mmb cavern. For the leaching of 15 caverns at this site, a total of 30,000 gpm (1.03 million barrels/day) would be required. To leach one barrel of storage volume requires 7 to 8 barrels of raw water, depending upon the initial salinity of the water. At the proposed leach rate, new space would be created in each cavern at a rate of 255 gpm (8,750 barrels/day). Therefore, to leach 150 million barrels of storage capacity would require a leach period of 38 months.

For water supply during crude oil withdrawal operations, the water intake equipment would be designed to provide a maximum of 30,625 gpm (1.05 million barrels/day) necessary to displace 150 million barrels in a period of no less than 150 days, since displacement requires 5 percent more water than the amount of oil displaced. The intake structure would be constructed to insure that the induced intake velocities would remain below 0.5 ft/sec to minimize problems of organisms clogging the screens or being entrained.

A.5.4.1.4 Brine Disposal System

The system designed for brine disposal at Black Bayou calls for a 27 mile x 36 inch pipeline into the Gulf of Mexico for direct disposal into the sea. The pipeline route presently being considered would pass through marsh for the entire distance but would follow an existing Transcontinental Gas Pipeline Company (TCGPL) right-of-way for 90 percent of the distance (see Figure A.5-7).

The leaching process would produce a less-than-saturated brine at about 230 ppt (parts per thousand) concentration. During the initial leaching process, brine would leave the caverns at a combined rate of 29,450 gpm (67,300 barrels/day per cavern), somewhat less than the water injection rate due to the space created by the enlarging cavern. Brine disposal at this rate would continue over a period of 38 months.

The initial oil fill and subsequent oil refill cycles would produce a nearly saturated brine of about 265 ppt concentration. Oil fill and refill is planned at a rate of 175,000 barrels per day for the 150 million barrel facility. The brine would be displaced at the same rate over a period of 28 months.

The brine leaving the caverns would empty into a 175,000 barrel brine settling and surge pond at the central plant area (see Figure A.5-6). The pond is sized to provide a 4 hour retention time for the maximum brine flow rate to allow for sufficient surge capacity, some settling, and also for observation of the system to detect any oil mixing with the brine. The brine pumps (7 at 600 hp each) would lift the brine from the pond to transfer it at a pressure of 150 psi through the pipeline to the Gulf of Mexico.

The proposed brine disposal pipeline route to the Gulf of Mexico would leave the central plant area across the storage site for 0.3 miles following other onsite pipelines (see Figure A.5-2). The route would then turn southwest for 0.4

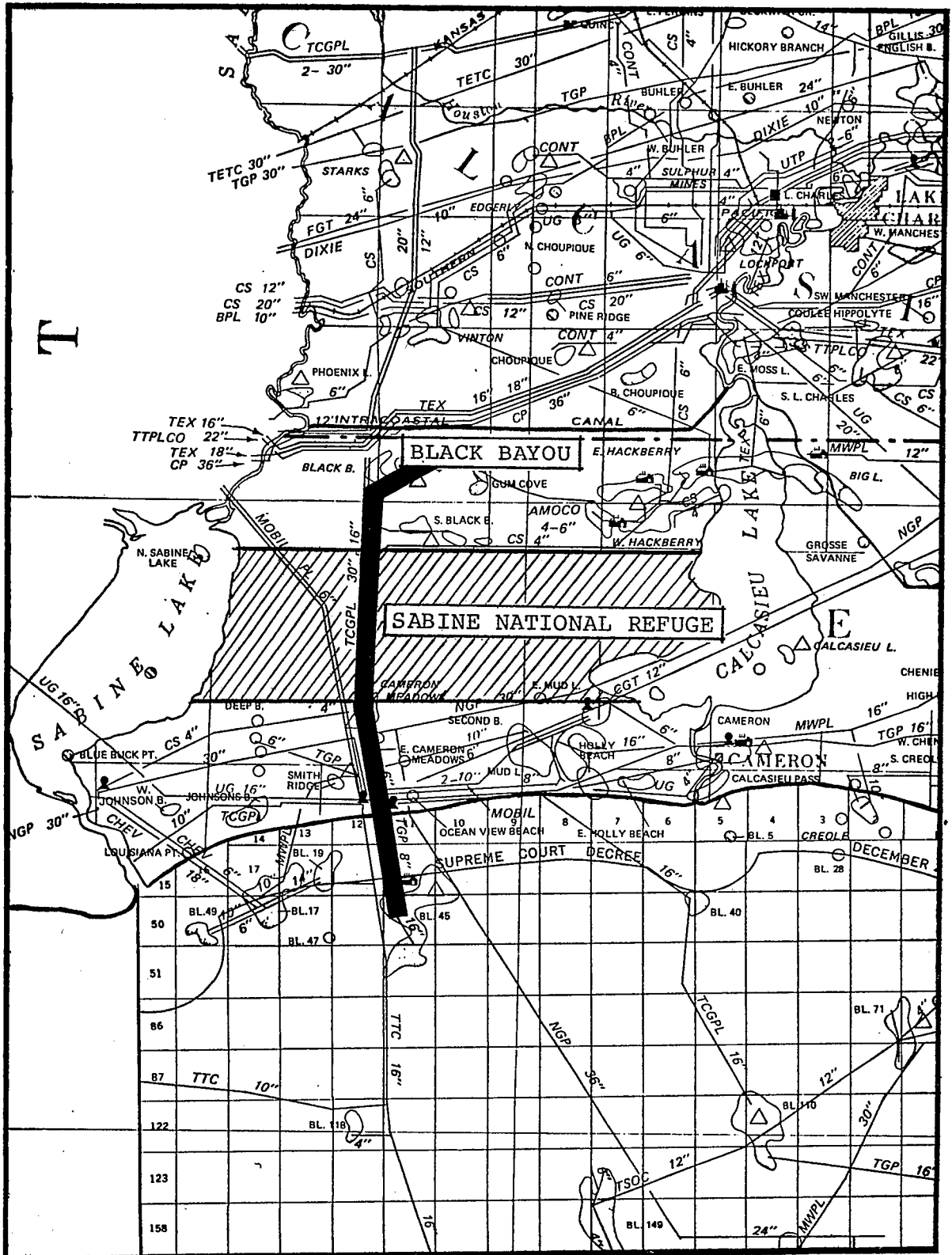

Figure A.5-7 Brine Disposal Pipeline Route

miles along Black Bayou and then 2.0 miles across marsh until it intersects the TCGPL pipeline right-of-way (see Figure A.5-7). It would follow this existing pipeway the remaining distance to the coast. The entire route is in marshland. It also would pass through the Sabine National Wildlife Refuge for 9.1 miles along the existing pipeline corridor. The route would cross Black Bayou again near the northern boundary of the Refuge, and then the North Bayou near the southern boundary of the Refuge. Old East Bayou and a coastline highway would be crossed near Ocean View Beach.

The proposed pipeline would then extend into the Gulf of Mexico for 7 miles along the ocean bottom to the diffuser location which lies in 30 feet of water. The total length of this pipeline route is 27.0 miles. See Table A.5-3 for a comparison of the land required for the various land types crossed by the route.

A.5.4.1.5 Distribution System

As an alternative to the expansion of the ESR facility at West Hackberry, the Black Bayou site is ideally located for tying into the West Hackberry distribution system. The ESR pipeline planned between West Hackberry and the Sun Terminal at Nederland, Texas, would pass within 2.7 miles of the Black Bayou storage site (see Figure A.5-3). A 2.7 mile connection along Black Bayou Cutoff to the West Hackberry pipeline on the ICW (plus the required pumps and tanks), are the only developments necessary to complete the distribution system for Black Bayou. The system would be connected to the existing distribution network at Sun Terminal. From there the stored oil would be distributed inland by pipelines or to the east coast by tanker. For discussion of the SPR facilities at the terminal, see Section A.4.4.1.6.

According to present proposals, the 42 inch pipeline connector would be buried along one side of the Black Bayou Cutoff channel bottom (see Figure A.5-2). A minimum of 5 ft. of cover would be required to maintain safe clearance for barge traffic. The total pipeline length from Black Bayou to Nederland is 28 miles.

During initial fill operations, oil would be injected into the caverns at a combined rate of 175,000 barrels/day for 28 months required to fill the 150 mmb facility.

During a national oil supply interruption, SPR oil would be withdrawn over a period of 150 days. Thus the distribution of 150 million barrels stored at Black Bayou would result in a delivery rate of 1.0 million barrels/day to the Sun Terminal. The present plan is to distribute 60 percent of this oil (600,000 barrels/day) by tankers loading at Sun Terminal to the East Coast and Caribbean markets. The remaining 40 percent (400,000 barrels/day) would be transported inland by pipelines, including the Texoma Pipeline which initiates at the Sun Terminal, and distributed to local refineries.

A total of 5 fill and withdrawal cycles are planned for the life of the facility. During the 4 subsequent refill operations, a fill rate of 175,000 barrels/day over a period of 28 months would be required to regain the original 150 million barrel capacity. Although the available storage space would increase during each withdrawal cycle, it is assumed that only the initial storage capacity would be refilled each time. Subsequent withdrawal cycles would be completed in 150 days at the same 1.0 million barrels/day rate.

During oil withdrawal operations, the oil would be displaced from each cavern and the pipeline booster pumps (used for oil injection during fill operations) would deliver the oil through the pipeline to the Sun Terminal. A 20,000 barrel utility surge tank and a 3,000 barrel blanket oil tank (Figure 2.5-6) would be required at the storage site. The larger tank is needed to divert oil from the pipeline to prevent spills during any injection system malfunction. It would also be used to store oil retrieved from a potential oil spill at the site. The blanket oil tank would be used during the initial leaching of the cavern sumps before the concurrent leaching and fill operations begin.

A.5.4.1.6 Land Requirements

About 230 acres would be needed at Black Bayou to develop the onsite facilities. This area would include 10 to 12 acres for the central plant and 15 acres for dredge disposal, in addition to the required storage wells, access canals, and water intake station.

The brine disposal pipeline to the Gulf of Mexico would require a permanent right-of-way totaling 163.7 acres. A larger area (248 acres) would be affected during the pipeline construction (see Table A.5-3).

TABLE A.5-3 LAND REQUIREMENTS FOR PIPELINES

		BRINE DISPOSAL	OIL DISTRIBUTION CONNECTION
DRY LAND	M*	<u>0.3</u>	
	P	1.8	
	C	2.7	
MARSH	M	<u>19.3**</u>	<u>0.8</u>
	P	117.0	4.8
	C	351.0	14.4
INLAND WATER	M	<u>0.6</u>	<u>1.9</u>
	P	3.6	11.5
	C	3.6	11.5
OFFSHORE	M	<u>7.0</u>	
	P	42.5	
	C	42.5	
TOTAL	M	<u>27.0</u> miles	<u>2.7</u> miles
	P	163.7 acres	16.0 acres
	C	248.0 acres	26.0 acres

*M - distance in miles

P - area required for permanent right-of-way in acres

C - area required for construction right-of-way in acres

** Includes 17.3 miles along existing TCGPL pipeline right-of-way.

The oil distribution pipeline connection would require a permanent right-of-way totaling 16 acres. About 26 acres would be affected during its construction.

Thus a total of 410 acres would be permanently committed for the development of the Black Bayou site and associated offsite pipeline rights-of-way.

A.5.4.2 Alternative Physical Facilities

The feasibility of several alternative systems components were considered in the Black Bayou SPR development program.

A.5.4.2.1 Raw Water Supply

Three alternative surface water sources were considered in lieu of the proposed water intake station on Black Bayou. Since it is proposed to construct a brine disposal line to the Gulf, the option of building a parallel water supply line was suggested. This pipeline would cost approximately \$11 million to construct. Also required would be a remote pumping station on an offshore platform. Such platforms typically cost about \$1.6 million. An intake structure on Black Bayou and an onsite supply pipeline, on the other hand, could be completed for \$700,000. In addition, a remote power supply would be needed for the pumps at the offshore site. Extensive multiple screening would be required at the offshore intake to minimize entrainment of organisms, and technical problems with biological fouling of the pipeline would exist for a very long pipeline.

Another possible source for water supply would be the ICW about 3 miles north of the site. The ICW has a cross sectional area approximately 24 times greater than that of Black Bayou, but as discussed in Appendix C.4.2.2.1, the induced flow rates in the bayou, which would draw directly from the ICW as an ultimate source, would be less than 0.134 ft/sec with insignificant environmental consequences. This alternative would require a longer water supply pipeline and the construction of an offsite pumping station on the bank of the ICW. The required pipeline would follow the same route 2.7 miles along Black Bayou Cutoff channel as proposed for the oil distribution pipeline connection. Thus no additional land would be affected for pipeline construction. About one additional acre would be required, however, to locate an intake and pumping station on the south spoil bank area of the ICW. The pumping station would include a dredged sump of about the same size as proposed for Black Bayou. It would also require a separate transformer area to provide power for the pumps. A security fence would enclose the entire pumping station.

A third alternative source would be to construct an 11.0 mile pipeline to the northeastern edge of Sabine Lake. The route would follow the same route as proposed for the brine disposal pipeline (see Section A.5.4.1.4) for the first 3.7 miles across the marsh to the southwest of the dome and then south along the existing TCGPL pipeline right-of-way to Black Bayou near Right Prong. The route would then diverge in a southwesterly direction across open marsh for 2.1 miles to Green's Bayou and then 5.2 miles across Pine Ridge to Sabine Lake. Pine Ridge is a section of mostly dry land bounded on the north and south by portions of Sabine National Wildlife Refuge. Natural dry lands within this extensive marsh region are potential sites of historical and archaeological significance, and a careful survey would be conducted should this alternative be chosen. The cost of constructing a pipeline over this route would be approximately \$4.4 million in addition to an expensive remote pumping station and intake structure required on Sabine Lake. For a permanent right-of-way beyond the point of divergence from the proposed brine pipeline, 45 acres would be needed. Moreover, approximately 92 acres of marshland would be disturbed during construction for that segment of the pipeline.

The possibility of drilling a series of wells into saline aquifers was also considered. Due to the size of the required yield (approximately 31,000 gpm maximum), and based on an estimated per well yield rate of 1000 gpm, the Black Bayou facility would require a 31-well system. Based on a cost per well of \$150,000 for a total of \$4.6 million (not including land costs) when compared to \$700,000 for a surface water supply system, the cost of constructing a deep aquifer well system at Black Bayou would be prohibitive.

A.5.4.2.2 Brine Disposal

As an alternative to a brine pipeline to the Gulf of Mexico a deep well injection system for brine disposal was considered for Black Bayou. For purposes of comparison, the ESR development at West Hackberry would include a deep well injection system for brine injection. The system at West Hackberry is designed for 11 wells to handle 11,800 gpm and would require about 36 acres of land for construction. An expanded system to accommodate a maximum flow rate of 30,000 gpm during additional leaching for the SPR facility at Black Bayou would require about 30 wells spaced over a 5.9 mile long corridor which would require a permanent canal to be cut through the marsh or a permanent roadway on fill. At least 70 acres of marsh land would be permanently committed.

In the preliminary analysis of the ESR injection system at West Hackberry (FES 76/77-4, January 1977), it was shown that after 5 cycles of brine injection, aquifer pressure would build from 3000 psig to 3450 psig - well under the estimated fracture pressure of 4500 psig. An expanded system at Black Bayou, however, would inject brine at 3 times the rate calculated for the ESR at West Hackberry, and would consequently subject the aquifers to much greater pressures. If brine injection is to be seriously considered for brine disposal for the expansion program at West Hackberry, then a complete pressure analysis will be conducted to determine the engineering feasibility of this plan and the likelihood of the aquifer fracturing.

Although the cost of developing a deep well injection system would not cost any more and would probably cost somewhat less than a pipeline to the sea, and although such a system could be technically feasible, the ecological loss due to the construction of a permanent 5.9 mile canal or roadway through productive marshland would be significantly greater than the temporary ecological disruption due to pipeline construction.

A.5.4.2.3 Distribution

The distribution pipeline to the Sun Terminal at Nederland, which is planned for construction under the ESR development at West Hackberry, would be used for the Black Bayou site. Another route (e.g., a direct route to Sun Terminal) would require a longer pipeline over more sensitive biological areas and areas of archeological value in the marshlands west of Black Bayou with subsequently more cost and greater environmental impacts.

A.5.5 Construction Techniques

A.5.5.1 Road Construction and Other Grading

No new roads would be required at Black Bayou. Existing access roads would provide vehicular access to the central plant site.

The central plant site and the equipment yard would require an estimated 91,000 cubic yards of landfill to raise the area above flood level. In some cases much of the dredge spoil could be used to build up these areas, but it often takes too long for the spoil to dry to a suitable firmness to allow construction on the fill. Thus it was assumed for the sake of assessment that the fill would be trucked in

The raw water pond, brine pond, and the oil containment area for the oil tanks would be created by landfill around the designated basins and then constructing dikes around the perimeter where needed. The 175,000 barrel brine pond and raw water pond would be approximately 300 ft by 370 ft and would be a total of 15 feet deep. The ponds are sized to contain fluid to depths of 10 feet, allowing one-third of their total capacities to serve as freeboard. The ponds would be constructed above the existing marsh elevation but essentially below the elevation of the landfilled central plant area. Although the main pond basins would be formed during the landfill operation, dikes approximately 7 feet taller than the elevation of the landfill would be required to form the required freeboard for the ponds. These dikes would be constructed at the time of the other earth moving. The amount of additional material required is approximately 9,000 cubic yards.

A.5.5.2 Pipeline Construction Techniques

For the pipeline routes presently planned, three general pipeline construction techniques would be used as discussed in Section A.4.5.2. The flotation method would be required for the onsite lines connecting the various wellheads and for laying the distribution line in Black Lake Cutoff to the ICW. Push-ditch construction would be used for the brine disposal line except for near the coast where a short distance may require conventional methods.

A.5.6 Development Timetable

According to present proposals, construction of the site facilities, pipelines, and external facilities would be accomplished during the first 5 months of development. Three drill rigs working simultaneously would drill the storage wells over a period of 18 months. After the first group of wells are completed, however, they would be connected to the system (month 4) so that initial leaching could begin. After 38 months of initial leaching, the first group of cavity wells would be available to begin the oil fill process (see Table A.5-4). The initial oil fill process would take a total of 28 months to fill the 150 mmb capacity facility.

Table A.5-4 Timetable for Construction and Fill

<u>Month Period</u>	<u>Fill Rate (MB/D)</u>	<u>No. of Months</u>	<u>Cum. Storage (MMB)</u>	<u>Phase of Development</u>
1-5	0	5	0	Site preparation
2-19	0	18	0	Drill and complete 15 wells
4-42	0	38	0	Initial leaching
42-70	175	28	150	Initial fill

A.5.7 Operation and Maintenance

These procedures would be essentially the same for the alternate SPR site as for the proposed SPR expansion site at West Hackberry. The operating procedures and the preventive maintenance required are discussed in Section A.4.7.

Since the Black Bayou facility is planned for the same capacity as the West Hackberry expansion facility, the distribution flow rates for the extraction phase and the refill phase would be as discussed in Section A.4.7.

A.6 ALTERNATIVE STORAGE SITE - VINTON SALT DOME

The development of the Vinton dome for the SPR program is considered as an alternative to the proposed expansion of the West Hackberry ESR facility described in Section A.4. As currently designed, the facility would satisfy 50 million barrels of the SPR crude oil storage requirements in the Texoma/Lake Charles/Beaumont storage region.

A.6.1 Location

Vinton salt dome is located in southwestern Calcasieu Parish of southwestern Louisiana, approximately 8 miles east of Orange, Texas, and 3 miles south of Vinton, Louisiana. The Gulf Intracoastal Waterway (ICW) is 5.5 miles to the south. The site is about 14 miles northwest of the West Hackberry dome (see Figure A.6-1).

Vinton salt dome lies within the Gulf Coastal Plain physiographic province. Surface elevation overlying the dome varies from five to over 30 feet above sea level, reflecting both a topographic high and low within the -2,000 foot depth of salt contour.

The dome is small and has a large lake (Ged Lake) covering approximately one third of the area. The remaining surface area is mainly pasture. All the land above the dome is part of the J. G. Gray Estate with leases held by Tribal Oil Company and Union Oil Company. Ged Lake, as reported by the Louisiana Fish and Game Commission, is owned by Mitilda Gray Streen of New Orleans, Louisiana. There is an estate house and other farm buildings and dwellings owned by the Gray family located west of Ged Lake directly above the salt dome area.

Since the first commercial oil and gas producer at Vinton in 1910, minor production has occurred all around the dome. Greatest density of drilling has been on the north and east edges of the salt dome.

Louisiana State Department of Conservation records show that oil or gas are currently being produced from five zones whose upper limits range from -4,908 to -5,840 feet. No oil or gas storage activities are being conducted over the top of the dome in the area proposed for the storage facility.

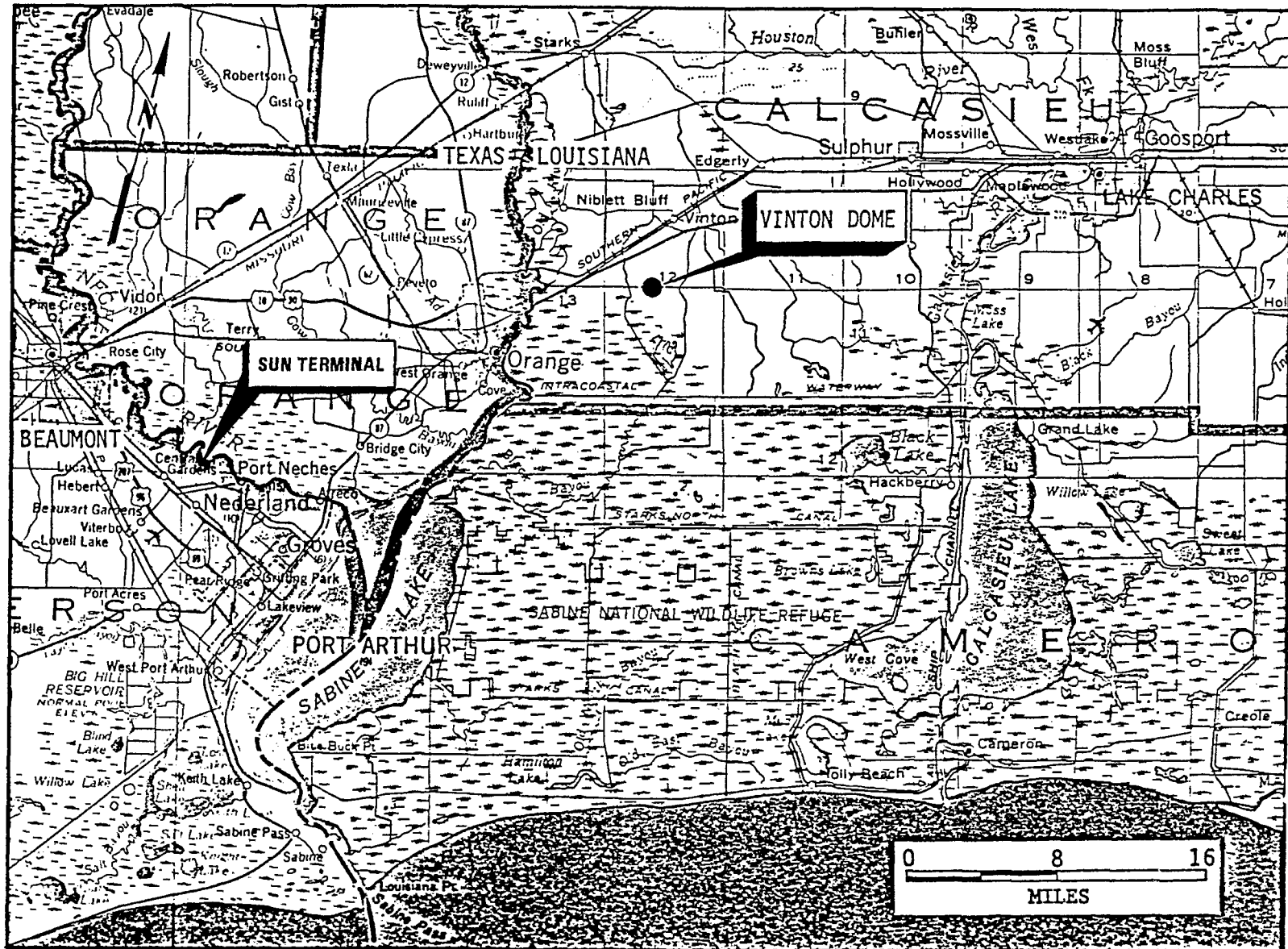

Figure A.6-1 Location Map - Vinton Dome

Highway access from Lake Charles or from Beaumont is first via Interstate 10 to Vinton, and then a 3.0 mile parish road which leads to the north edge of the dome. A network of improved gravel and shell roads services the periphery of the salt dome for the oil production activities in the area. These roads would be suitable for construction equipment access.

Barge and river traffic access may be possible via the Vinton drainage canal, which lies about 1.5 miles east of the dome. It is about 5.5 miles by water from a point lateral with the dome on the Vinton drainage canal to the ICW. From that point on the ICW it is about 8.5 miles to Orange, Texas.

The site is well situated for distribution of oil via an additional 7.5 mile pipeline connected to the proposed ESR line from West Hackberry to the Texoma facilities at Nederland, Texas, which is 26 miles southwest of the Vinton dome. From the Nederland facilities the stored oil would be moved to local and regional refineries via inland pipelines including the Texoma pipeline, or loaded onto tankers for delivery to Eastern and Caribbean refineries. Other than the proposed means of distribution, local refineries could be connected to the site by new and existing pipelines. Vinton Dome lies within 35 miles of eight major area refineries, which are listed in Table A.6-1.

A.6.2 Capacity

The capacity under consideration for this site is 50 million barrels. Initial plans call for five 10 million barrel caverns. However, based on the engineering feasibility study for the site, if in drilling some of the wells, severe lost circulation zones are experienced necessitating a reduction in casing sizes, the cavern would be reduced to 5 million barrels capacity and additional caverns would be developed to make up the 50 million barrel total. Thus 6 caverns are shown in Figure A.6-2 (four 10 million barrels and two 5 million caverns).

The caverns are expected to enlarge up to 77 percent by volume as a result of five complete fill and withdrawal cycles. The layout indicated on Figure A.6-2 places caverns on 800 foot centers and the caverns are located a minimum of 600 feet from the dome edge, thus providing a minimum salt wall of 400 feet around every cavern.

Due to increased leaching caused by fresh water injected during withdrawal cycles, the storage caverns would increase from 275 ft in diameter to about 400 ft in diameter for the 10 mmb caverns and 190 ft to 250 ft for the 5 mmb caverns after 5 cycles. The 1000 ft height of each cavern would be maintained.

Table A.6-1 Beaumont/Port Arthur/Lake Charles Refineries

<u>Company - Location</u>	<u>Capacity (BPD)</u>	<u>Distance (Mi) from Vinton Dome</u>
Cities Service - Lake Charles	268,000	16
Conoco - Lake Charles	83,000	20
American Petrofina - Port Arthur	26,000	28
Gulf - Port Arthur	312,100	28
Mobil - Beaumont	325,000	34
Texaco - Port Arthur	406,000	28
Texaco - Port Neches	47,000	22
Union - Nederland	127,000	24

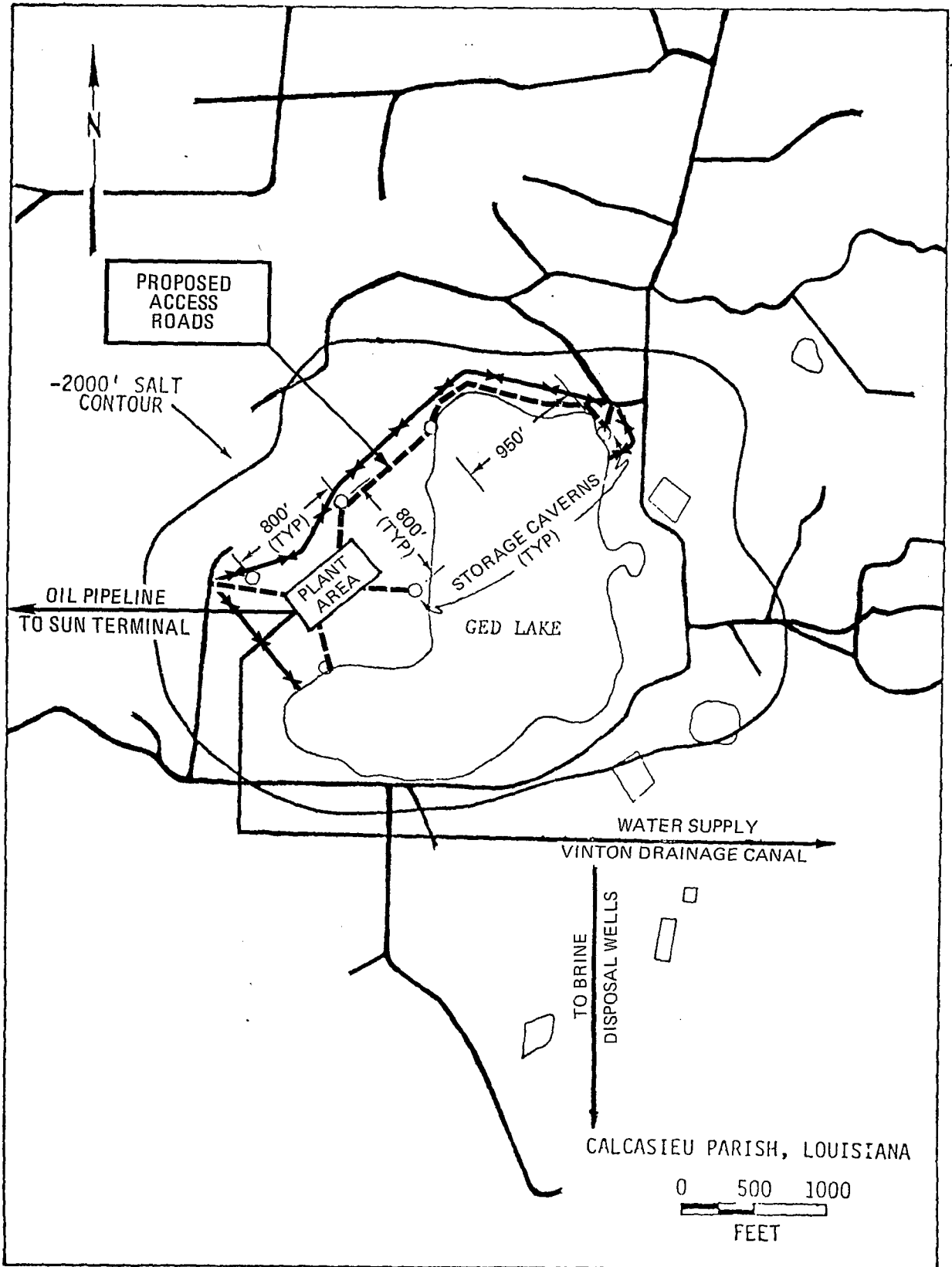

Figure A.6-2 Storage Site Layout - Vinton

The Vinton dome is a small dome consisting of approximately 240 acres within the -2,000 foot salt contour. Utilizing all available acreage, the dome has a potential for approximately twelve 10 million barrel caverns. These figures include an allowance for growth of each cavern after five fill and withdrawal cycles.

A.6.3 General Systems Description

The proposed development of Vinton dome would involve the leaching of 6 new caverns (four 10 mmb and two 5 mmb) along the northern and western shore of Ged Lake (Figure A.6-2). To create the new caverns requires pumping fresh water through the wellheads into the salt and displacing salt brine out through annular well tubing (see Appendix J).

The central plant, including pumps, surge ponds and surface tanks, would be located on dryland to the west of Ged Lake.

As currently proposed the raw water intake would be located on the Vinton Drainage Canal approximately 1.5 miles east of the site. Dredging of an inlet at that point would be required to ensure constant water supply independent of waterway traffic.

Brine created by construction and operation of the solution mined storage facility would be disposed of by injecting it into subsurface saline aquifers. A deep well injection system with 10 wells is proposed and would be located about 2.0 miles south of the site (Figure A.6-3).

Crude oil supplies and distribution would be handled through Sun Terminal following the construction of a new pipeline (see Figure A.6-3) connecting the Vinton site with the ESR pipeline being constructed between West Hackberry and Sun Terminal (Figure A.6-4). Crude oil supply would be from tankers exclusively and distribution operations would employ both tankers and the inland pipelines, including Texoma. More detail on each of the proposed system components is discussed in the following subsections.

A.6.4 Site Development

A.6.4.1 Proposed Physical Facilities

A.6.4.1.1 Site Layout

The 6 storage wells at the Vinton dome facility would be spaced 800 feet apart and would all be located on dryland as

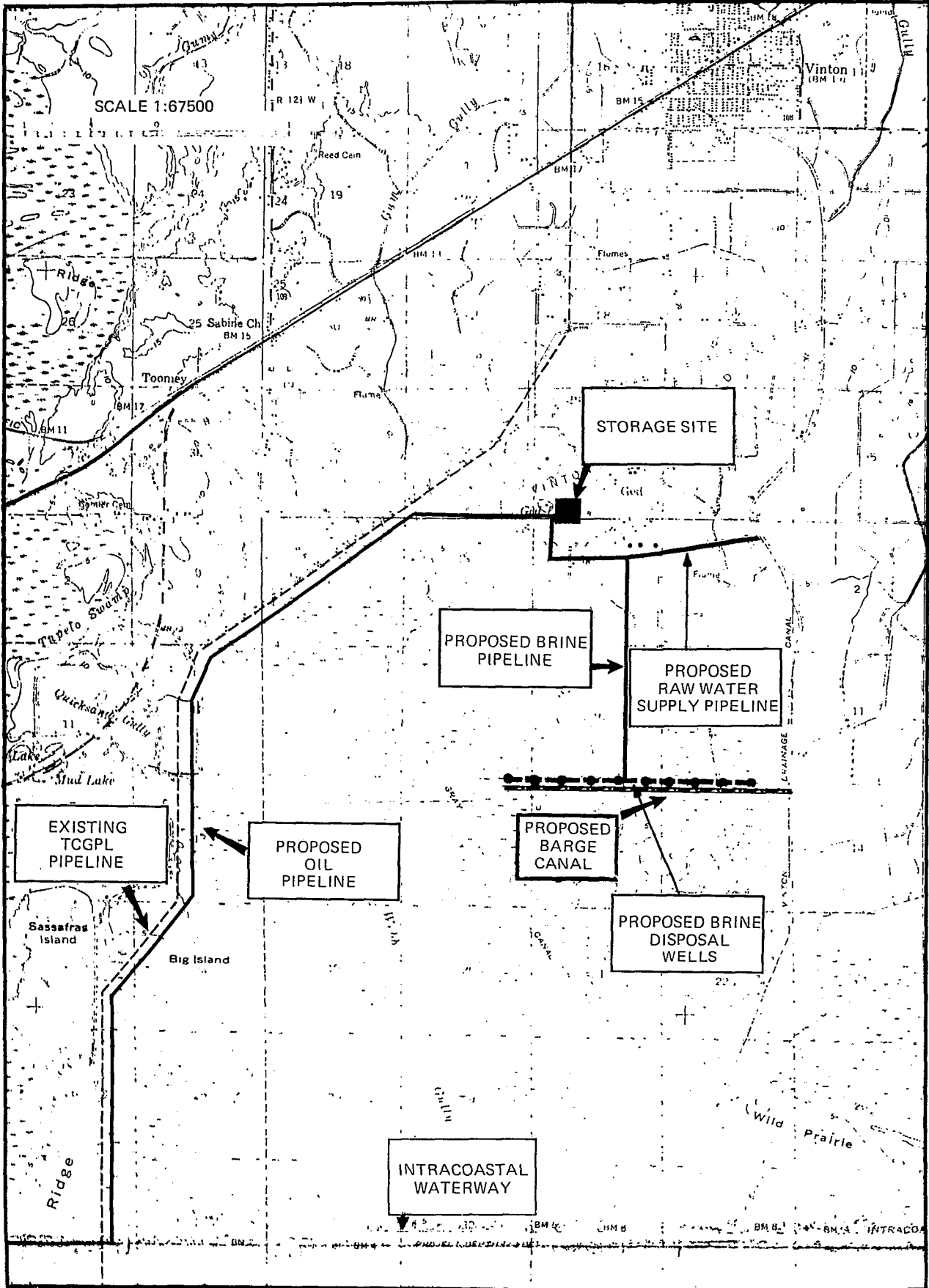
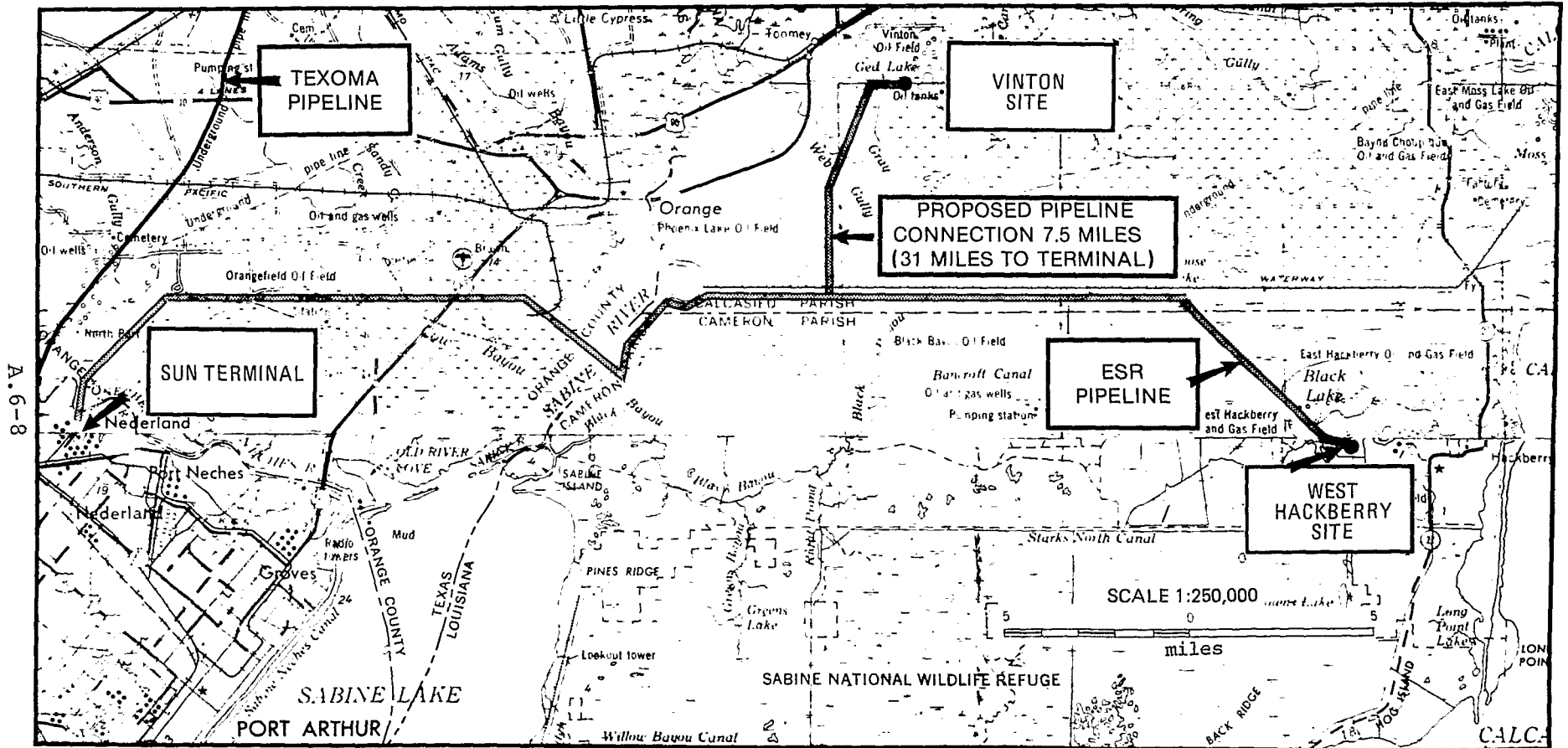

Figure A.6-3 Systems Components Layout



A.6-8

Figure A.6-4 Oil Distribution Pipeline Route

shown in Figure A.6-2. New roadways would be required for access to the wells and central plant facilities. Approximately 1.0 mile of new road construction would be needed. All roadways would be located on dryland, requiring a minimum of clearing and grading. The one well located on the far north side of the lake would be connected by pipelines supported on pilings across the lake. It has been assumed that all other onsite lines would be buried. This is an accepted method for plants located on dryland. A tentative piping diagram for this site is given on Figure A.6-5.

Due to the dryland at this site, the wellheads would not require special structures such as platforms. The current wellhead design employs a system of concentric tubing, allowing the flow of two separate fluids. Further detail on these wellheads can be found in Appendix J.

A.6.4.1.2 Central Plant Facilities

Preliminary designs indicate that oil injection pumps, brine injection pumps, and raw water injection pumps would be housed in a central pump building or similar noise dampening structure located in the central plant area (see Figure A.6-6). Electric pumps and equipment would be used with power being supplied by local utilities.

Oil pumps are used for injection and withdrawal operations. Pipeline transfer pumps (located at Sun Terminal) are used for pumping oil to the site. Fill operations require oil transfer, oil injection, and brine disposal pumps. Withdrawal operations require oil displacement, water supply pumps and oil injection pumps used for transfer to the dock. Tentative pump requirements are given in Table A.6-2.

A building would be required to house the main office, all electrical control equipment, a repair shop, and a chemical laboratory. At this lab, brine samples would be analyzed to calculate the rate of new leaching. Also, tests would be conducted on crude oil samples to determine their compatibility with other stored oils.

The buildings would be built upon concrete slabs. In cases of insufficient soil bearing strength, reinforced concrete piles would support beams upon which the floor would be laid.

Also shown in Figure A.6-6 are tanks and ponds as needed for operation and construction (described in later sections). In the case of all surface oil tankage, retention dikes are planned as required by 40 CFR 112.7. Dike enclosures are a standard engineering practice for compliance with these regulations.

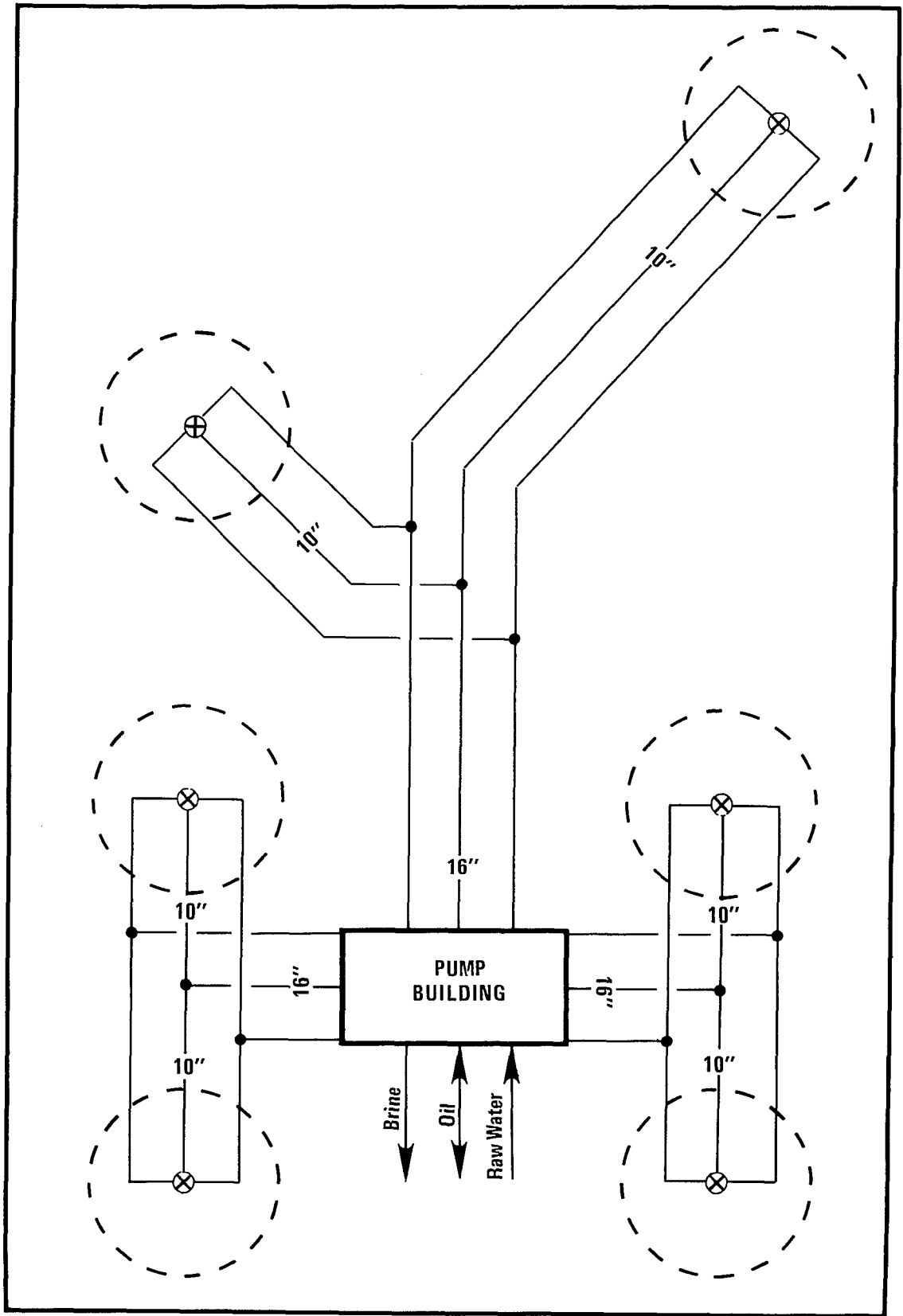

Figure A.6-5 Pipeline Flow Diagram

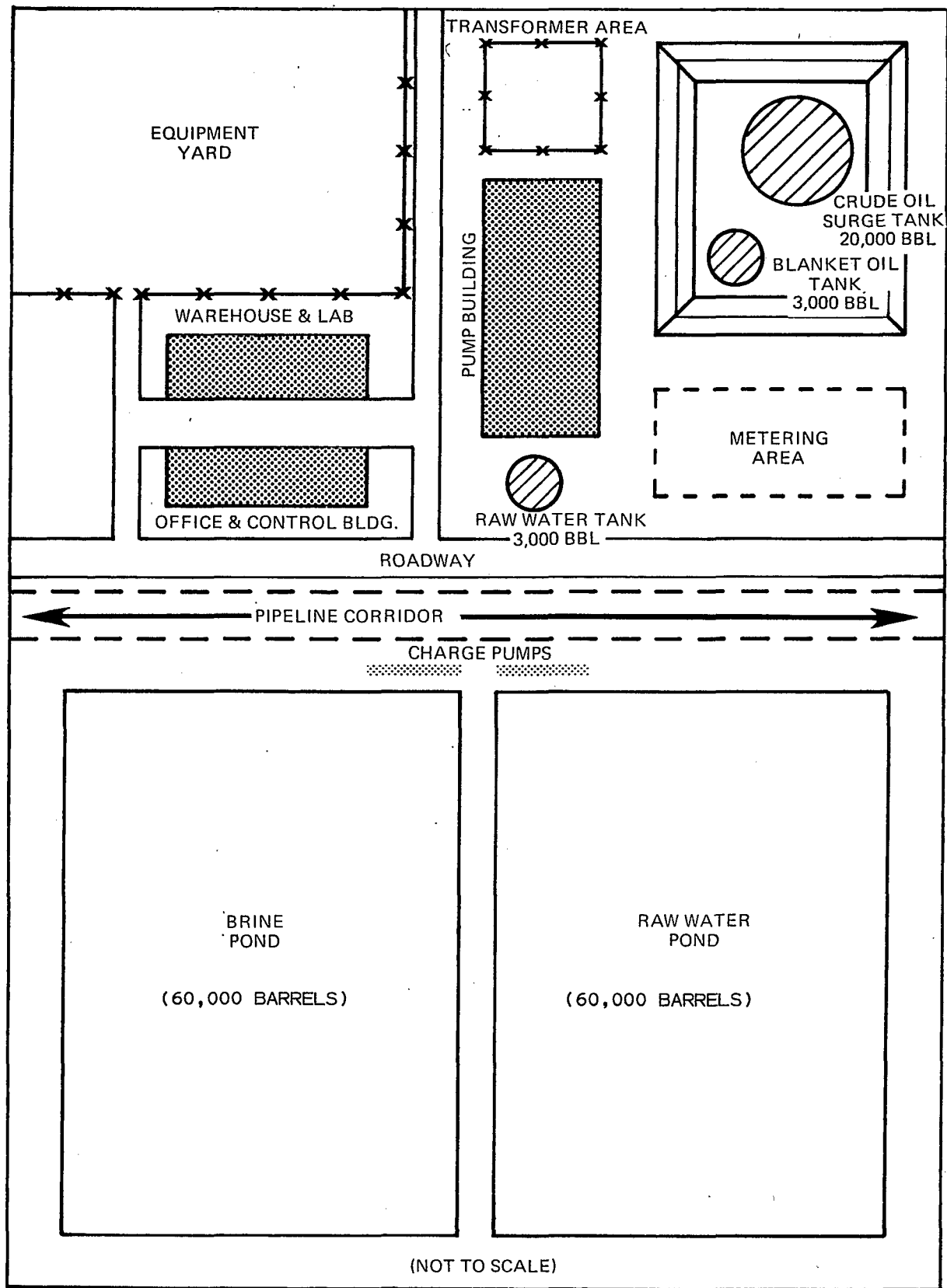

Figure A.6-6 Central Plant - Preliminary Layout

Table A.6-2 Pump Requirements - Vinton

Pump	Quantity	Horse- power	Discharge Pressure (psi)	Total Design Flow Rate (B/D)
Oil Injection	4 1 (Stand-by)	500 500	900	58,300
Blanket Oil	1	100	1000	3,500
Displacement	5 2 (Charge)	1150 90	650 50	350,000
Water Supply	3	450	150	350,000
Oil Transfer: Dock to Site	1 1 (Stand-by)	500 500	150	58,300
Oil Transfer: Site to Dock	3	500	150	334,000
Brine Disposal	8 2 (Charge) 1 (Stand-by)	1500 175 1500	1300 50 50	336,000
Tanker Load	2	1000	100	334,000

A.6-12

The plant area would be an estimated 6 acres and would require a minimum of clearing and grading. Adjacent to the plant area would be an equipment yard of roughly 4 acres. A security fence would enclose both the plant area and equipment yard.

A.6.4.1.3 Raw Water System

For the leaching of new caverns and for the displacement of stored oil, raw water would be supplied from the Vinton drainage canal located about 1.5 miles east of the dome (Figure 2.6-3). This waterway is about 100 feet wide by 15 feet deep and is connected to the ICW 5.5 miles to the south.

The pipeline to this area would be a 36 inch line proceeding from the central plant area due south across the dome for 0.4 miles. Then it would turn east for about 0.6 miles (prairie) and northeast along a light duty road for 1.25 miles until it intersects with the canal. The final leg includes 0.9 miles of prairie and 0.35 miles across wooded area ending at the western spoil bank of the canal. The pipeline would be a total of 2.25 miles in length. The intake station would be built on an inlet dredged off the Vinton drainage canal to avoid any interruption of water supply due to ship traffic.

The intake structure design would follow standard engineering procedure and pumps would be in compliance with the Hydraulic Institute Standards. It would consist of can type pumps submerged to a minimum depth of 3 to 4 feet. The intake cans would be located in the dredged inlet as mentioned above, and would be sized to create an intake velocity of 0.5 feet per second or less. This would minimize entrainment of aquatic organisms resulting in less environmental impact and bio-fouling of the intake screening structures.

During initial leaching of the cavern, the design water flow rate would be 2000 gpm (68,600 barrels/day) per 10 million barrel (mmb) cavern. For leaching the equivalent of five 10 mmb caverns at this site the total daily volume of water required would be 343,000 barrels. To leach one barrel of storage volume requires 7 to 8 barrels of raw water, depending on the initial salinity of the supply water. The total amount of raw water required to leach out this 50 million barrel facility would be about 391 million barrels over a period of 38 months.

For a total displacement of 50 million barrels of crude oil over a 150 day period, the rate of raw water required is an average of 350,000 barrels per day (10,200 gpm), since

displacement requires 5 percent more water than the amount of oil displaced. Fifty-eight million barrels would be the average amount of water needed for each of five withdrawal cycles, taking cavern enlargement into account. Total water used over the lifetime of this site would be 681 million barrels.

Other components of this system include a raw water tank, pond, and pumps (Figure A.6-6). Water taken from the canal would be pumped at 150 psi to the site by three 450 hp pumps located at the intake station. The water would be briefly maintained onsite in a raw water pond so that large, undissolved impurities could settle out before the water is injected. The water displacement pumps would be five 1150 hp units (650 psi) that would be primed by two 90 hp units (50 psi) with water supplied from a 3000 barrel tank.

The raw water holding pond would be designed to accommodate the largest volume of water pumped during any four hour period. The water would be held for this amount of time for settling and surge purposes. This pond was sized according to the initial leaching flow rate (343,000 barrels/day) and was therefore designed to hold 60,000 barrels. This is a volume of 12,500 cubic yards resulting in a pond with average dimensions of about 150 x 225 x 10 feet deep. The walls of the pond would be sloped at 45 degrees for structural integrity. The material removed during construction of this pond would be used for earthen dikes at the site (see Oil - Distribution System), and for the construction of roads and building foundations.

A.6.4.1.4 Brine Disposal System

The current design specifies brine disposal into saline aquifers 5000 feet below the surface. The brine would flow through a 24 inch epoxy lined steel pipe to the disposal wells and injected into the ground. The wells are located approximately 2 miles south of the site and consist of 10 wells in a linear array with 1000 foot intervals. Approximately eight of the ten wells would be in a marsh with access by a new barge canal (Figure A.6-3). These wellheads would be constructed on 30 x 30 foot elevated platforms and therefore, no land fill would be required. The new barge canal, which would be approximately 2.2 miles long by 80 feet wide by 7 feet deep, traverses both marsh and dry land so that the drill rig barges would have easy access to all the well sites. The total amount of material removed during the dredging of this canal would be about 241,000 cubic yards. The disposal of this dredged material along the banks of these canals would cover approximately 35 acres of marsh.

The pipeline leading to the disposal wells would be a total of 2.75 miles in length. Beginning at the central plant area it would head south across prairie for 0.5 miles crossing a small road in the process. The route would turn east for 0.75 miles following the same route as the proposed water supply pipeline, and then south for 1.5 miles, all across prairie. At this point it would intersect with the well connecting pipelines at approximately midpoint of the disposal field.

The pipelines between the disposal wells would be valved at a central location so that use of any specific well could be achieved. The brine flow would also be metered to monitor the pressure buildup in the underground aquifer so that its integrity would not be breached.

During initial leaching of the six caverns the total brine flow rate would be equal to the water injection rate plus 85 percent of the space created by the dissolved salt, minus the new space which is occupied by brine which remains in the cavity space. Therefore, the brine disposal rate would be 336,000 barrels/day for the entire site. The total amount of brine disposed during this initial leaching would be 383 million barrels over a 38 month period.

Brine would also be disposed during oil fill and refill operations. The rate of this disposal would be equal to the oil injection rate, or 58,300 barrels/day. The total amount of brine disposed during initial fill and four refill cycles would be 250 million barrels.

Other components of the brine disposal system are a brine surge pond and a bank of pumps (Figure A.6-6). The pond, which would be a 60,000 barrel lined open structure, would be designed with a four hour holding time (during the highest brine flow rate experienced). The brine would be held to allow for settling before it is pumped to the disposal field and injected into deep wells. The pond would also serve as a surge point in the event of an injection well back-up or system rupture. The dimensions of this pond would be approximately 150 x 225 x 10 feet deep with the walls sloped at 45 degrees for structural integrity. About 12,500 cubic yards of earth would be removed during construction of this pond that would be used for dikes, roads or building foundations on the site.

The brine disposal and injection system would employ eight 1500 hp pumps operating at about 1300 psi. For priming, charge pumps would be used (Table A.6-2).

A.6.4.1.5 Oil Distribution System

Crude oil would be pumped between the Vinton site and Sun Terminal in Nederland, Texas via a proposed 31 mile long pipeline. A new 7.5 mile x 42 inch pipeline would connect with the oil pipeline being constructed from the West Hackberry ESR site to the Sun Terminal as shown on Figure A.6-4. Thus the 31 miles from the Vinton site to Sun Terminal would utilize 23.5 miles of the proposed ESR pipeline.

The route of this pipeline connection would proceed due west from the site for 1 mile across prairie, crossing Gray Canal in the process. At this point the line would meet with an existing pipeline right-of-way (TCGPL) and follow it to the ICW. The course of the existing right-of-way from the point of intersection travels in a southwest direction covering 1.25 miles of prairie and 1 mile of marsh. The route would then turn south covering 2 miles of prairie and 0.25 miles of marsh, swinging southwest for 1 mile, half prairie and half marsh. From this point it would run due south to the ICW, crossing 0.75 miles of prairie, 0.5 miles of marsh, and a dirt road. The pipeline would then cross the ICW and intersect with the ESR distribution pipeline between West Hackberry and Sun Terminal. See Section A.4.4.1 for a description of this route to the Sun Terminal.

Both oil supplies for storage and then distribution of the stored oil would be handled at Sun Terminal. Dock capability is presently 70,000 DWT (410,000 barrel) tankers, but future plans include new docks with accommodations for up to 130,000 DWT (910,000 barrel) tankers. Further information about the Sun Terminal can be found in Section A.4.4.1.6.

A 20,000 barrel oil tank would be located on site for surge purposes. This tank would be a cylindrical steel structure approximately 40 feet high and 60 feet in diameter. The dike surrounding the tank would be designed to contain the total volume of the tank in the event of a major leak. The dike would be an earth structure about 5 feet high and 100 x 225 feet in size. Considering 45 degree banked walls on both sides for integrity, the amount of earth needed for this dike would be 20,800 cubic yards. Also inside this dike area would be a 3000 barrel blanket oil tank. The blanket oil is required during leaching operations to maintain a high pressure oil layer above the brine (as described in Appendix J). The approximate dimensions of this tank would be 20 feet high with a 32 foot diameter.

Crude oil flow rates during the initial fill and refill operations would be 58,300 barrels/day. The total time per fill or refill would be 28 months.

The distribution pipeline would be connected to the manifold side of the oil injection pumps. These pumps would serve to inject oil during fill and transfer oil to the terminal during withdrawal. The injection pumps would be four 500 hp units operating at 900 psi, designed for 2500 gpm flow rates at this pressure. When used as oil transfer pumps during withdrawal (site to terminal), the flow would be at 10,000 gpm (334,000 barrels/day) at 260 psi, requiring only three of the 500 hp pumps.

During fill operations oil would be transferred from the terminal to the site by pumps housed at Sun Terminal. These pumps are designed for 2500 gpm at 150 psi, needing only one 500 hp unit and suitable standby unit.

The pump used for the maintenance of blanket oil during initial leaching is designed to operate at 1000 psi with a low flow rate of about 100 gpm. A 100 hp pump would be required for this task.

A.6.4.1.6 Land Requirements

The central plant area would require 6 acres of land including ponds and tanks. An additional 4 acres would be required adjacent to the central plant for the storage of equipment such as parts and machinery. Total land area at the site including central plant, wellheads and access roads, would amount to approximately 60 acres directly north and west of Ged Lake.

The land requirements for the proposed pipeline routes are given in Table A.6-3. As noted, a 50 foot permanent right-of-way is required for maintenance of the pipeline. During construction, however, a temporary 75 foot right-of-way is needed on dry land and 150 feet on wet land.

The intake station on the Vinton drainage canal would require 1 acre, including a dredged inlet.

Total permanent land requirements for all proposed pipeline routes and physical facilities associated with this site would be approximately 150 acres.

A.6.4.2 Alternative Physical Facilities

The feasibility of several alternative system components were considered for the Vinton SPR site.

Table A.6-3 Land Requirements (Acres)

		Dry Land	Marsh	Woodland	Roads
Oil Pipeline	A	34	12	-0-	.3
	B	51	3	-0-	.5
	C		36		
Water Supply Pipeline	A	12	-0-	2	.5
	B	17		3	.75
	C		-0-		
Brine Pipeline	A	17	-0-	-0-	.3
	B	25		-0-	.5
	C		-0-		
Brine Disposal Field (pipeline only)	A	4	7	-0-	-0-
	B	6		-0-	-0-
	C		22		

NOTE: A - Permanent right-of-way = 50 feet
 B - Dry land construction right-of-way = 75 feet
 C - Wet land construction right-of-way = 150 feet

A.6.4.2.1 Raw Water System

Three possible alternatives were considered in lieu of the proposed use of Vinton drainage canal for raw water supply. Since it is proposed to construct an oil pipeline to the ICW, the option of laying a parallel water supply line along the same right-of-way was suggested. The ICW has a cross sectional area approximately 22 times greater than that of Vinton Canal, but as discussed in Appendix C.5.1.2.1, the induced flow rates in Vinton Canal, which would draw directly from the ICW as an ultimate source, would be acceptable at the prescribed water supply rates. Moreover, this pipeline would be 5.25 miles longer than the proposed route, and at \$320,000 per mile, would amount to an additional expense of \$1,680,000. It would also increase the environmental impact on marsh between the site and the ICW due to constructing two pipelines along the route, and would require more electrical power to pump the water a greater distance.

Ged Lake, which lies directly adjacent to the site, was considered as a possible raw water source. Initial cost and pump power requirements for this alternative would be less than required for the proposed system. However, the lake is shallow (3 feet), and has a total volume of approximately 2 million barrels. During initial leaching, a supply rate of 343,000 barrels/day for a period of 38 months is required. At this rate, Ged Lake would be drained in 6 days, thus making it ineffective as a surface water reservoir.

Subsurface aquifers were also considered as possible sources of leaching water. These aquifers consist of massively bedded sands which extend from near the surface to deeper than -1,000 feet throughout the area. These sands contain volumes of fresh and brackish-to-saline water and are constantly recharged by an annual rainfall of 52 inches. Due to the size of the required yield (approximately 11,000 gpm maximum), and based on an estimated yield rate of 1000 gpm per well, the Vinton facility would require an 11-well system. Based on a cost per well of \$150,000 for a total of \$1.6 million (not including land costs), the construction of a deep aquifer well system would cost nearly twice as much as the surface water system (\$980,000).

A.6.4.2.2 Brine Disposal System

The only environmentally acceptable alternative to deep well brine injection would be disposal into the Gulf of Mexico. An additional 35 miles of pipeline would be required at a cost of about \$34 million as opposed to \$6 million for the entire

brine field and pipelines. There would also be more environmental impacts associated with the construction of the longer pipeline, and the risk of brine spill during operation would be increased. This option is therefore unreasonable in light of environmental and economic considerations.

A.6.4.2.3 Oil Distribution System

The distribution pipeline to Sun Terminal at Nederland, which is currently planned for construction under the ESR development at West Hackberry, would also be used for the Vinton site via a 7.5 mile pipeline connection. Any other distribution method would require a longer new pipeline over similar terrain or more developed areas (e.g., a direct route to Sun Terminal) and subsequently more cost with no fewer environmental impacts.

A.6.5 Construction Techniques

A.6.5.1 Road Construction and Other Grading

Road access to the site already exists, but new roads would be needed for wellhead access (Figure A.6-2). Approximately one mile of improved dirt roads would be constructed within the fenced site area over dry prairie and would require only a minimal amount of grading and graveling. Improved dirt roads already exist between the dome area and the intake station area on the Vinton drainage canal.

The central plant area would require very little clearing and no land fill. Earthen dikes would be built around all surface oil tanks with the capability of containing the entire volume of the tank. The earth removed while constructing the two 60,000 barrel ponds would be used for dikes along the perimeters of the ponds and also for dikes around the surface tanks. Dikes would be five feet high and require 20,800 cubic yards of earth at this site. The earth removed during the pond construction would amount to 25,000 cubic yards, about half of which would be built up around the perimeter since the water level would be above ground level. The remainder of the earth required for tank dikes would be obtained from surface grading near buildings.

A.6.5.2 Pipeline Construction Techniques

For the pipeline routes proposed, three methods of pipeline construction would be required as discussed in Section A.4.5.2. The flotation method would be required for the pipelines connecting the brine disposal wells (1.9 miles long) which are

located in marsh. Push-ditch construction would be used for other offsite pipeline routes passing through marsh (2.25 miles). Conventional dryland construction would be used for the onsite pipelines between wellheads and plant facilities, as well as the raw water supply pipeline (2.25 miles). When crossing any navigable body of water, hydraulic or bucket dredges are used to dig a channel in which to lay the pipe.

A.6.6 Development Timetable

According to present plans, construction of the site facilities, pipelines, and external facilities would be accomplished during the first 5 months. Drilling the storage wells and brine disposal wells would begin from month 1. After 4 months, leaching should begin in the first caverns, taking 38 months to complete. After leaching, the caverns could be filled at faster rates but the fill process is now planned for a 28 month period (see Table A.6-4).

A.6.7 Operation

These procedures have previously been discussed in Section A.4.7. Emergency withdrawal remains at 150 days and thus requires a withdrawal flow rate of about 333,400 barrels/day for this 50 million barrel site.

The refill flow rate would be a constant 58,300 barrels/day requiring about 28 months of a constant oil supply.

Table A.6-4 Timetable for Construction and Fill

<u>Month Period</u>	<u>Fill Rate (MB/D)</u>	<u>No. of Months</u>	<u>Cum. Storage (MMB)</u>	<u>Phase of Development</u>
1-5	0	5	0	Site preparation
1-19	0	18	0	Drill and complete 6 wells
2-16	0	15	0	Drill 10 disposal wells
4-42	0	38	0	Initial leaching
42-70	58.3	28	50	Initial fill

A.7 ALTERNATIVE STORAGE SITE - BIG HILL SALT DOME

The development of the Big Hill salt dome for the SPR program is considered as an alternative to the proposed expansion of the West Hackberry ESR facility described in Section A.4. This facility, as planned, would contain 100 million barrels of stored oil in the Texoma/Lake Charles/Beaumont storage region.

A.7.1 Location

The Big Hill salt dome is located in southwestern Jefferson County (see Figure A.7-1), approximately 26 miles southwest of Nederland, Texas and 70 miles east of Houston. It is positioned nine miles northwest of the Gulf of Mexico, 5.3 miles north of the Intracoastal Waterway (ICW), 3.2 miles north of the Spindletop Ditch (which is a barge canal connecting to the ICW), and immediately north of an extensive marsh area stretching to the coast.

This salt dome, which lies within the Gulf Coastal Plain physiographic province, is a conspicuous topographic feature of the local area. It rises more than 25 feet above the surrounding plain to a maximum elevation of 37 feet above sea level. The mound is almost circular in shape, with a valley incised on the northwest edge. Country surrounding the dome is typical Gulf Coastal Plain, with a slope toward the Gulf of about one and a half feet per mile.

Most of the land above the -2000 foot depth to salt contour is owned by John Pipkin and the Pan American Petroleum Company with the North rim owned by the Pure Oil Company. Houston Oil Company holds leases on land in the southwest quadrant where they have been producing oil since 1923. Since then, production has been developed on all but the east rim of the dome. Pure Oil Company has two solution mined LPG storage caverns, with capacities of 326,000 and 314,000 barrels, located along the north flank of the salt dome. However, there is no oil or gas storage activities over the top of the dome in the area proposed for the storage facility.

Road access to the dome from Port Arthur is possible by traveling 20 miles southwest along State Highway 73, then south for five miles along Big Hill road (county road). Several roads already exist on the dome itself and would be used in the network for accessing the wellheads.

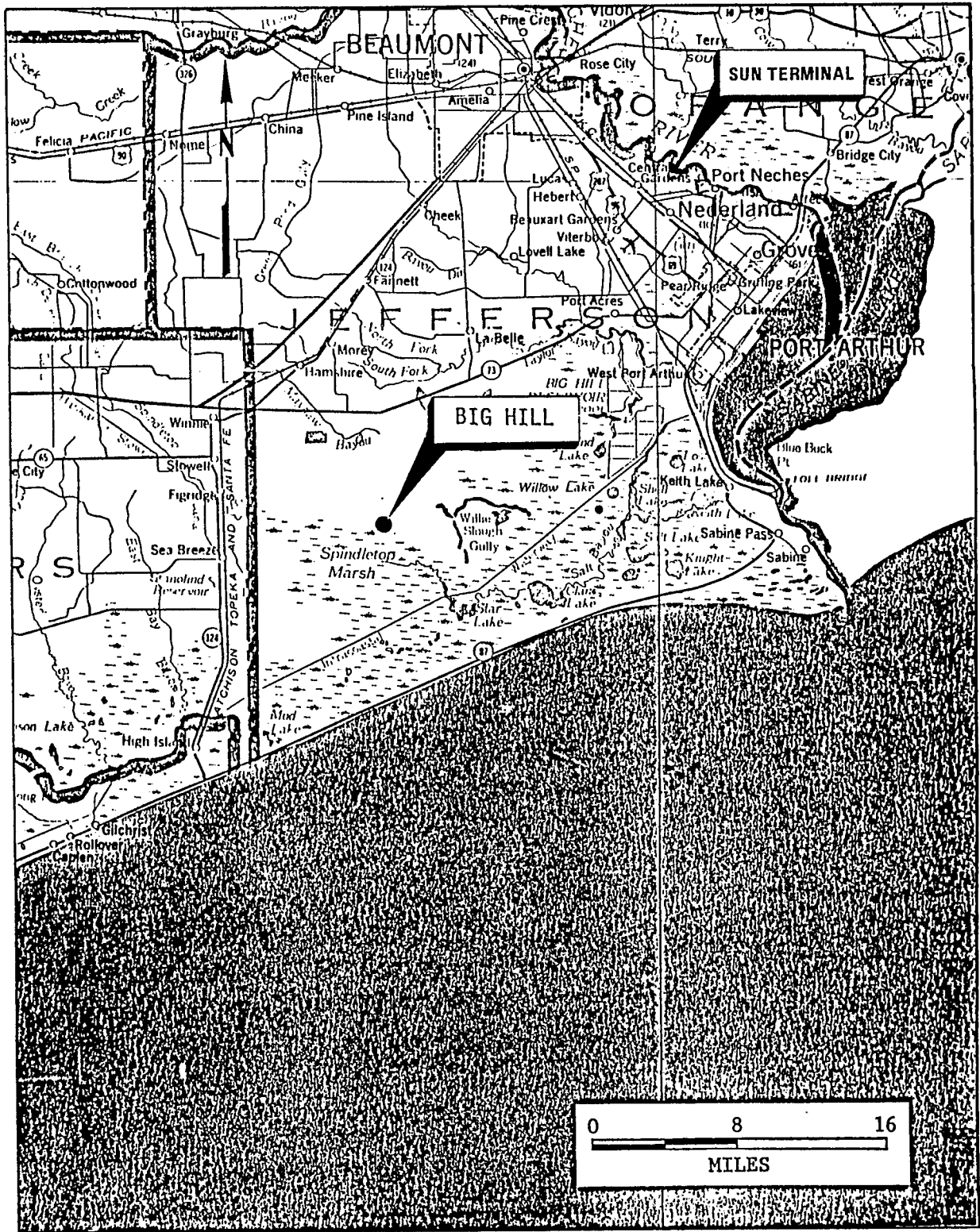

Figure A.7-1 Location Map - Big Hill Dome

The site is favorably located with respect to Sun Oil Distribution Terminal 26 miles away (Figure A.7-1). This terminal, the initiating point for the Texoma Pipeline, also has existing capabilities for 130,000 DWT (910,000 bbl) tankers. The Neches River Channel presently accommodates fully loaded 70,000 DWT tankers, because of the existing 40 ft. channel depth.

Other than the proposed means of distribution, local refineries could be connected to the site by new and existing pipelines. The proposed facility at Big Hill is located within 30 miles of 6 major refineries as noted in Table A.7-1.

A.7.2 Capacity

The capacity being considered in the assessment of this site is 100 million barrels. Initial plans call for ten 10 million barrel caverns. However, based on the engineering feasibility study for the site, if in drilling some of the wells severe lost circulation zones are experienced necessitating a reduction in casing sizes, the cavern would be reduced to 5 million barrels capacity and additional caverns would be developed to adhere to the 100 million barrel design capacity. The configuration of the caverns as appears on Figure A.7-2 includes eight 10 million barrel caverns and four 5 million barrel caverns. Noteworthy is that the caverns are presently proposed in the center of the dome; this is due to the lack of salt overhang data for the south, west, and east flanks of the dome (see Appendix B.2.1.2).

The caverns are expected to enlarge up to 77 percent by volume as a result of five complete fill and withdrawal cycles. Due to increased leaching caused by fresh water injected during withdrawal cycles, the storage caverns would increase from 275 ft in diameter to about 400 ft in diameter for the 10 mmb caverns and 190 ft to 250 ft for the 5 mmb caverns after 5 cycles. The 1000 ft height of each cavern would be maintained. The layout indicated on Figure A.7-2 places caverns on 800 foot centers and the caverns are located a minimum of 600 feet from the dome edge, thus providing a 400 foot wall around every cavern after 5 cycles.

Considering that there are 600 acres within the -3000 foot depth to salt contour, discounting areas of known salt overhangs, the Big Hill dome has a potential for storing approximately 250 million barrels of oil in 25 ten million barrel caverns. This capacity also leaves room for an increase in cavern volume as a result of fill and withdrawal cycles.

Table A.7-1 Beaumont/Port Arthur Refineries

<u>Company - Location</u>	<u>Capacity (BPD)</u>	<u>Distance (Mi)</u>
American Petrofina - Port Arthur	26,000	20
Gulf - Port Arthur	312,000	20
Mobil - Beaumont	325,000	32
Texaco - Port Arthur	406,000	20
Texaco - Port Neches	47,000	27
Union - Nederland	127,000	26

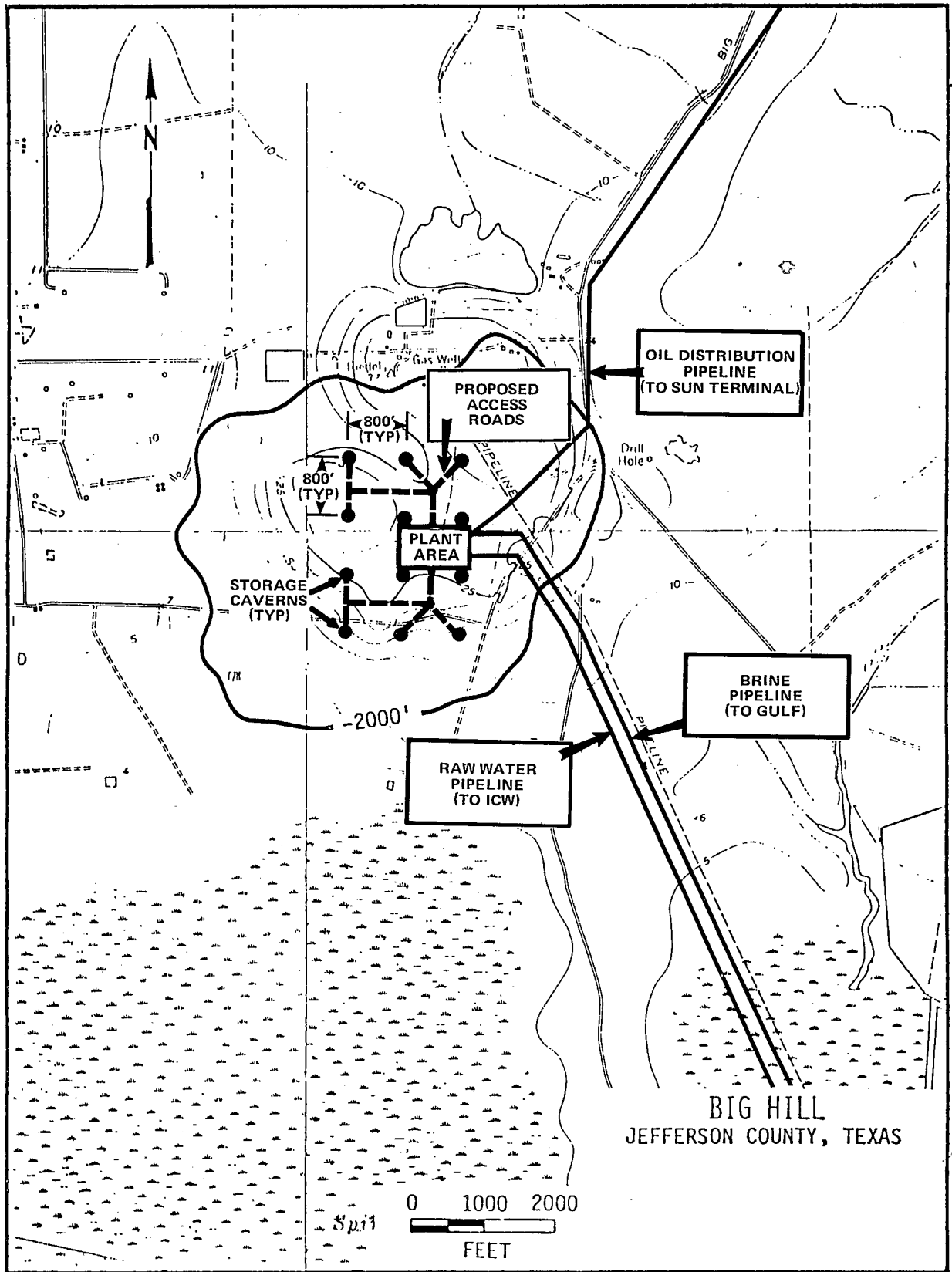

Figure A.7-2 Storage Site Layout - Big Hill

A.7.3 General Systems Description

The presently planned SPR facilities involve the leaching of 10 to 12 new cavities. Oil supplies of 100 million barrels of crude oil would be supplied from Sun Terminal in Nederland, Texas via a new proposed 27 mile oil pipeline (Number 1 on Figure A.7-3).

The crude oil supplies would be injected into the salt caverns through the well tubings by pumps located in a central pump building on the storage site. The existing brine in the cavity would thus be displaced and disposed of. The proposed plan for brine disposal is to the Gulf of Mexico through the 13.2 mile pipeline numbered 2 on Figure A.7-3. For the leaching of cavities and withdrawal of the stored oil, water would be supplied from the ICW using the 5.5 mile pipeline numbered 3 on Figure A.7-3.

There would be three alternatives to the above mentioned pipelines (numbers 4, 5 and 6 on Figure A.7-3). These are discussed in Section A.7.4.2.

The central plant, including pumps, surge pumps and surface tanks, would be located on dry land approximately in the center of the dome.

A.7.4 Site Development

A.7.4.1 Proposed Physical Facilities

A.7.4.1.1 Site Layout

The twelve proposed caverns (eight 10 mmb and four 5 mmb) would be arranged in a 3 x 4 linear array as shown in Figure A.7-2. They are positioned in the center of the dome to avoid any conflicts with existing production around the rim of the dome.

On solid dry ground, such as exists at the Big Hill site, the wellheads at the storage wells would not require special structures (e.g., platforms). Some land has been cultivated on the high portions of the hill over the dome, indicating that farming is being conducted in the area. It is assumed the onsite pipeline connectors would be buried. A tentative piping diagram for this site can be seen in Figure A.7-4. Notice that the pipes are arranged in a parallel configuration so that the wells are independent of one another.

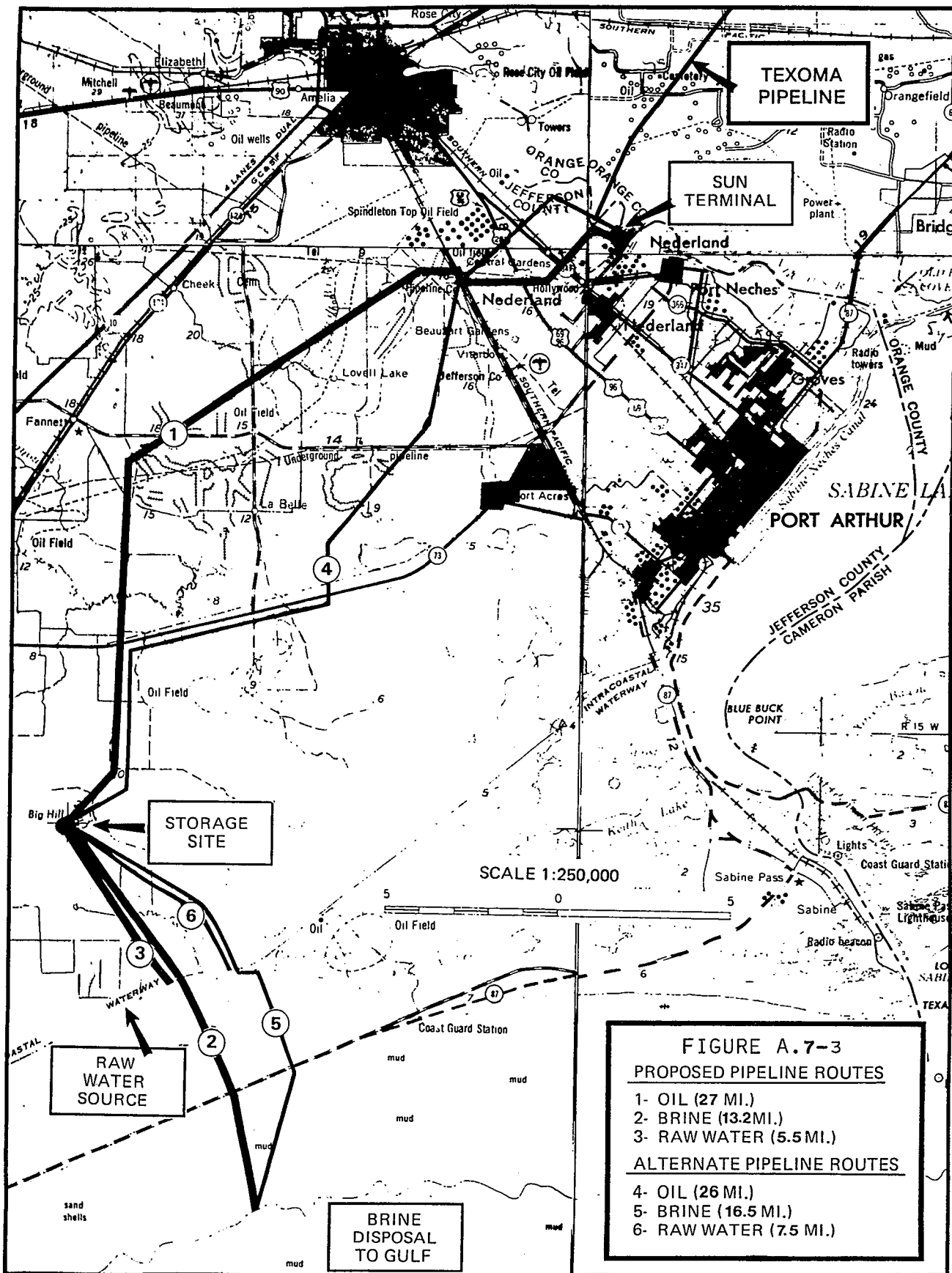

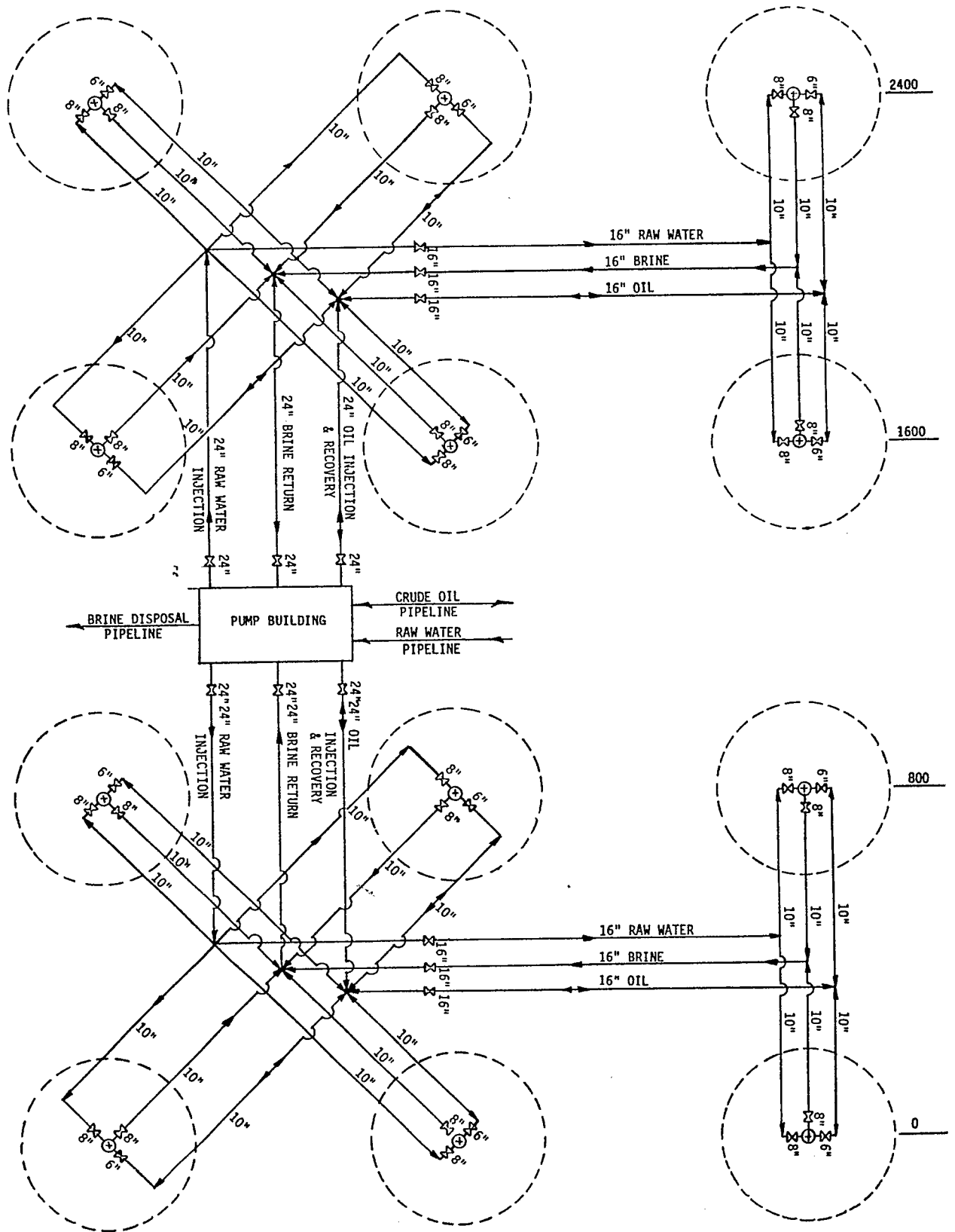

Figure A.7-4 Pipeline Flow Diagram

All the roadways on site for access to wellheads would be on dry land, requiring a minimum of clearing and grading. About 1.5 miles of new roadways would be needed.

A.7.4.1.2 Central Plant Facilities

Preliminary designs indicate that all oil injection pumps, brine injection pumps, and raw water injection pumps would be housed in a central pump building or other noise dampening structure located in the plant area (see Figure A.7-5).

The current designs specify that all pumps and equipment would be electric with power being supplied by local utilities. Oil pumps are used for injection and withdrawal operations. Pipeline transfer pumps would be located at Sun Terminal for pumping oil to the site. Fill operations require oil transfer, oil injection, and brine disposal pumps. Withdrawal operations require oil, displacement, and water supply pumps. Tentative pump requirements are given on Table A.7-2. A manifold system in the plant area would be used to direct the flow and would not be housed in a building.

A building would be required to house the main office, all electrical control equipment, a repair shop, and a chemical lab. At this lab, brine samples would be analyzed to calculate the rate of new leaching. Also, tests would be conducted on crude oil samples to determine their compatibility with other stored oils.

Buildings required for housing pumps, control equipment, laboratory, and repair shops would be built upon concrete slabs. In cases of insufficient soil bearing strength, reinforced concrete piles would support beams upon which the floor would be laid.

Also shown in Figure A.7-5 are tanks and ponds as needed for operation and construction (described in later sections). In the case of all surface oil tankage, retention dikes are planned as required (40 CFR 112.7). Dike enclosures are a standard engineering practice for compliance with this regulation.

The central plant would cover an estimated 10 acres, including an equipment yard, and would require a minimum of clearing and grading. A security fence would enclose both the plant area and equipment yard.

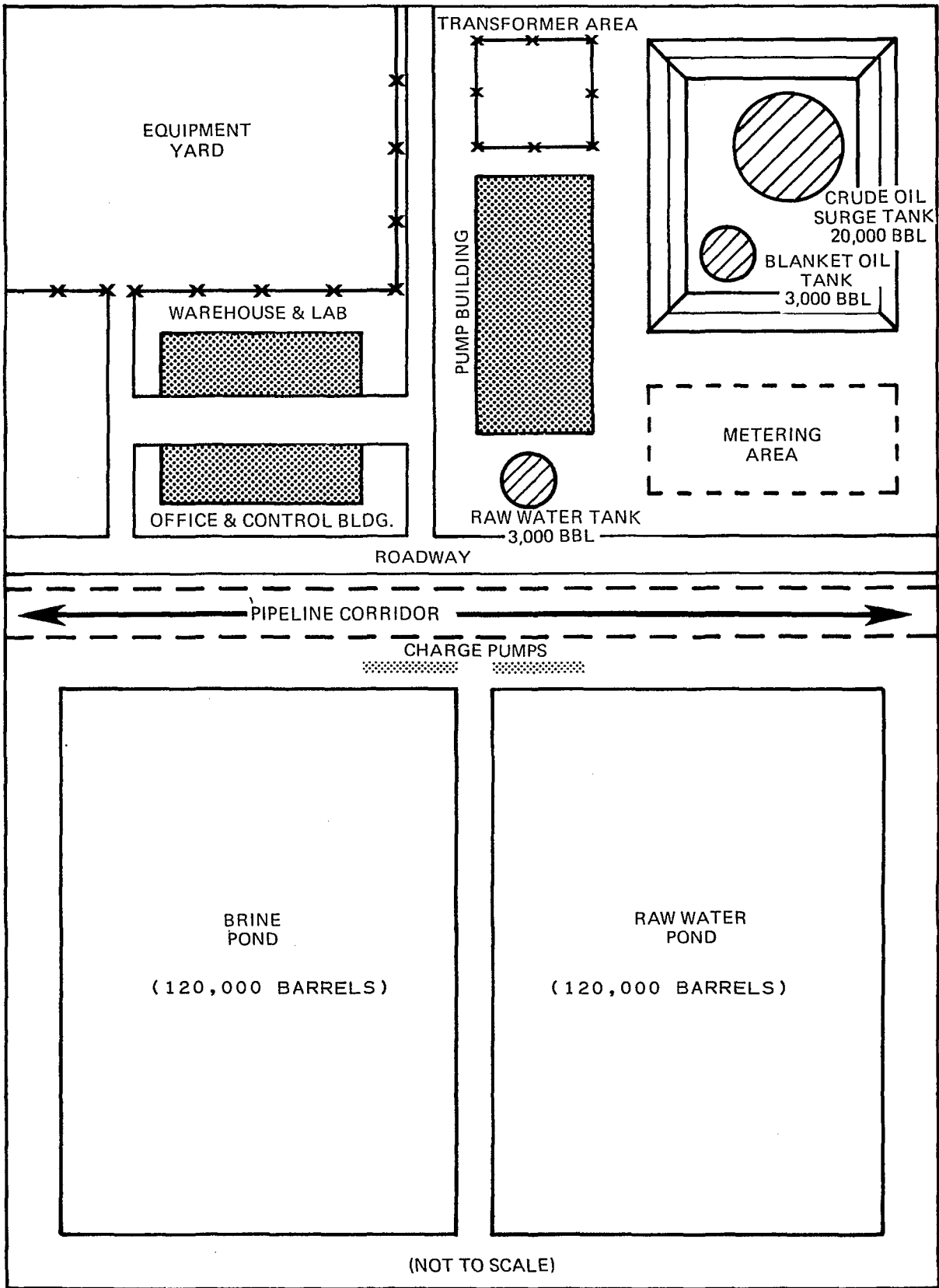

Figure A.7-5 Central Plant - Preliminary Layout

Table A.7-2 Pump Requirements - Big Hill

Pump Task	Quantity	Horse-Power	Discharge Pressure (psi)	Total Design Flow Rate (B/D)
Oil Injection	4 1 (Stand-by)	700 700	900	117,000
Blanket Oil	1	100	1000	3,500
Displacement	10 1 (Charge)	1150 90	650 50	700,000
Water Supply	4 1 (Stand-by)	700 700	150	700,000
Oil Transfer: Dock to Site	1 1 (Stand-by)	500 500	150	117,000
Oil Transfer: Site to Dock	5	500	150	667,000
Brine Disposal	6 6 (Charge)	500 50	150 50	672,000
Tanker Load	2	1470	100	667,000

A.7-11

A.7.4.1.3 Raw Water System

For the leaching of new caverns and for the displacement of stored oil, raw water would be supplied from the ICW located 5.5 miles south of the dome. The primary pipeline route under consideration is labeled as number 3 on Figure A.7-3. A 36-inch diameter pipe is planned for this route which extends in a southeastern direction away from the dome, following an existing pipeline right-of-way for 1.5 miles over prairie and 4 miles through marsh. It then intersects the ICW at which point an inlet would be dredged for the intake structure. By positioning the intake ports off of the waterway, any interruptions of a constant water supply due to barge traffic would be avoided.

The intake structure design would follow standard engineering procedure and pumps would be in compliance with the Hydraulic Institute Standards. The intake velocity would be at 0.5 feet per second or less, thus minimizing the environmental impact and bio-fouling of the intake screens due to impingement or entrainment of aquatic organisms.

During initial leaching of this 100 million barrel site, the total daily water flow rate would be 686,000 barrels/day. Over the 38 month period necessary to leach 100 million barrels of storage space, about 782 million barrels of water would be used.

For a displacement of 100 million barrels of oil over a 150 day period, the rate of raw water required would be an average 700,000 barrels/day, since it requires 5 percent more water than oil for displacement. The five withdrawal cycles would require an average of 105 million barrels of water per cycle. Total amount of water used over the five cycles (including leaching), at this site would be 1.30 billion barrels.

Other components of this system include a raw water tank, pond, and pumps (Figure A.7-5). Water taken from the ICW would be pumped at 150 psi to the site by four 700 hp units located at the intake station. On site the water would be briefly maintained in a raw water pond so that large, undissolved impurities could settle out before the water is injected. The water displacement pumps are ten 1150 hp units (650 psi), that would be primed by one 90 hp unit (50 psi), with water supplied from a 3000 barrel tank.

The raw water pond would be designed to accommodate the largest volume of water during any four hour period. The pond would therefore be 120,000 barrels in volume, with dimensions 250 x 275 x 10 feet deep. The walls of the pond would be sloped at 45 degrees for structural integrity. The material removed during construction of this pond, 25,000 cubic yards, would be used for earthen dikes at the site and for the construction of roads and building foundations.

A.7.4.1.4 Brine Disposal System

The proposed method of brine disposal is to the Gulf of Mexico via pipeline No. 2 on Figure A.7-3. The brine displaced during leaching and crude oil fill operations would be pumped through a 36-inch diameter epoxy-lined, steel pipe for direct disposal into the Gulf.

The pipeline route for brine disposal would extend in a southeasterly direction from the dome, following an existing pipeline right-of-way for 5.5 miles until it intersects with the ICW. This leg includes 1.5 miles of prairie, which is adjacent to the dome, and 4 miles of marsh and is the same route as proposed for the raw water supply pipeline. It crosses Salt Bayou and a dirt road in the process. The route would then cross the ICW (perpendicularly), and proceed 0.5 miles across marsh in the same general direction. Then, it would cross a branch of Star Lake and continue through marsh for about 3 miles to the Gulf Coast, crossing a dirt road along the way. At the coast, the pipeline would cross State Road 87 and coastal beach totaling 0.7 miles. The entire route to the Gulf Coast would be about 9.2 miles. The brine diffuser ports would be located about 3.5 miles offshore in a water depth of 30 feet. The total brine pipeline length would be 13.2 miles.

During initial leaching of the caverns, the total brine flow rate would be 672,000 barrels/day or a total of 766 million barrels over the 38 month leach period.

During the initial oil fill and subsequent refill operations, brine would be ejected from the caverns at a rate equal to the oil injection rate, 117,000 barrels/day. The total amount of brine disposed during initial fill and four refill cycles would be 500 million barrels.

The total brine released into the Gulf during the life of the project would therefore be 1.27 billion barrels.

Other components of the brine disposal system are a brine surge pond and a bank of pumps (Figure A.7-5). The pond would be a 120,000 barrel lined, open structure and would be designed for a four hour holding time during the highest brine flow rate experienced. This pond serves for detecting and removing any oil that may be mixed with the brine, as well as a surge point in the event of a system malfunction. The dimensions of this pond would be approximately 250 x 275 x 10 feet deep with walls sloped 45 degrees for structural integrity. About 25,000 cubic yards of earth would be removed during its construction and go into dikes, roads or building foundations on the site.

The brine disposal system would utilize six 500 hp pumps operating at 150 psi. Charge pumps would be used for priming (see Table A.7-2).

A.7.4.1.5 Oil Distribution System

Crude oil would be transported between the Big Hill site and Sun Terminal in Nederland, Texas via a new proposed 27 mile x 42 inch pipeline. Sun Terminal is the initiating point of the Texoma pipeline which would be used as part of the inland distribution of oil stored at Big Hill. Supply would be from tankers exclusively and distribution operations would utilize both tankers and inland oil pipelines to local and regional refineries as well as to Texoma. For oil supplied by tankers and for distribution by tankers, the terminal can presently accommodate 70,000 DWT (490,000 bbls) tankers, but plans are being made for 130,000 DWT (910,000 bbls) tanker capability. Further information about the Sun Terminal facility can be found in Section A.4.4.1.6.

A 20,000 barrel oil tank would be located onsite at Big Hill for surge purposes. This tank would be a cylindrical steel structure approximately 40 feet high and 50 feet in diameter. A dike surrounding the tank would be designed to contain the total volume of the tank in the event of a major leak. The dike would be an earth structure about 5 feet high and 100 x 225 feet in size. Considering 45 degree banked walls on both sides for integrity, the amount of earth need for this dike would be 20,800 cubic yards. Also, inside this dike area would be a 3000 barrel blanket oil tank. The blanket oil is required during leaching operations to maintain a high pressure oil layer above the brine (as described in Appendix J). The approximate dimensions of this tank would be 20 feet high with a 32 foot diameter.

The proposed distribution pipeline alignment for this site is shown as pipeline number 1 on Figure A.7-3. It would begin in a northeast direction away from the site and would proceed for approximately 3.5 miles along Big Hill road. At this point it would leave the road and cross prairie land for approximately 2 miles. It then would follow a medium-duty road for 1 mile, continue along the road for 0.5 miles through woodland, cross the South Fork Bayou, continue along the road through woodland for 0.5 miles before running into prairie land. It would cross over 0.75 miles of prairie land and run into woodland for 0.5 miles, cross the North Fork Bayou and continue along the road through marsh land and woodland for 0.5 miles. Continuing along the road for another one mile, it would cross prairie land until it meets with an existing pipeline right-of-way. The route would run parallel to the pipeline for approximately 11.5 miles, crossing various roads and small streams in a northeast direction. The route would follow the course of the pipeline for 3.1 miles across prairie land and then across Lovell Lake. It would continue through marsh for approximately 0.5 miles before returning to prairie land for 4.9 miles. Then the route would head due east following a power transmission line. The route would follow this line approximately 0.75 miles east, crossing the Southern Pacific Railroad track and West Port Arthur Road, turn southeast with the power line for 0.5 miles, turn east for 1.5 miles, crossing Highways 69, 96, 287, and finally following the power transmission line northeast for approximately 0.5 miles. It would then cross the Port Arthur Fresh Water Canal into the recreational area of Central Gardens for approximately 0.5 miles. After leaving Central Gardens the route would continue along the power line for approximately 0.5 miles, leaving dry land and entering marsh. The route would then follow a southeast direction along Smith Bluff approximately 1.50 miles through marsh to the final destination at the Sun Oil Terminal. The total length of this 42 inch diameter pipeline would be 27 miles.

The distribution pipeline would be connected to the manifold side of the oil injection pumps. These pumps would serve to inject oil during fill and to transfer oil to the terminal during withdrawal. The injection pumps would be four 700 hp units operating at 900 psi and designed for 3500 gpm flow rates at this pressure. When used as oil transfer pumps during withdrawal (site to terminal), the flow would be 20,000 gpm (667,000 barrels/day) at 260 psi, requiring all four 700 hp pumps.

During fill operations oil would be transferred from the terminal to the site by pumps housed at Sun Terminal. These pumps are designed for 3500 gpm at 150 psi needing only one 500 hp unit and suitable standby unit. The pumps required for the maintenance of blanket oil during initial leaching is designed to operate at 1000 psi with a low flow rate of about 100 gpm. A 100 hp pump would be required for this task.

Crude oil would be supplied for initial fill and subsequent refill operations at a rate of 117,000 barrels/day for 28 months.

Withdrawal operations are presently planned to cover a period of 150 days maximum. This would require constant raw water displacement rates and crude oil transfer rates to the terminal averaging 667,000 barrels/day.

A.7.4.1.6 Land Requirements

The central plant area at this site would require about 10 acres of land including ponds, tanks and other structures. The total land encompassed by the plant area and the twelve (eight 10 mmb and four 5 mmb) wellheads would be approximately 230 acres.

The land requirements for the proposed pipeline routes are given in Table A.7-3. As noted, a 50 foot permanent right-of-way is required for maintenance of the pipeline. During construction, however, a temporary 75 foot right-of-way is needed on dry land and 150 feet is needed over wet land.

The intake station on the ICW would require about one acre of area on the spoil bank. This includes the dredged inlet and area for the intake structures.

Total permanent land requirements for all proposed pipeline routes as well as physical facilities would be approximately 715 acres.

A.7.4.2 Alternate Physical Facilities

The feasibility of several alternative pipeline routes were considered for the Big Hill SPR site. These routes are numbered 4, 5 and 6 on Figure A.7-3, which correspond to oil distribution, brine disposal and water supply routes, respectively. The determination of the most viable routes would be based on economic feasibility, ecological impact, land ownership, and technical feasibility.

Table A.7-3 Land Requirements (Acres)

		Dry Land	Marsh	Woodland	Roads
Pipeline #1	A	118	16	8	2
	B	178		13	3
	C		47		
Pipeline #2	A	10	44	-0-	1
	B	15		-0-	1.5
	C		133		
Pipeline #3	A	6	25	-0-	-0-
	B	9		-0-	-0-
	C		75		
Pipeline #4	A	133	8	1	1.6
	B	199		1	2.5
	C		32		
Pipeline #5	A	40	25	-0-	1
	B	61		-0-	2.5
	C		76		
Pipeline #6	A	34	8	-0-	-0-
	B	51		-0-	-0-
	C		25		

NOTE: A - Permanent right-of-way = 50 feet
 B - Dry land construction right-of-way = 75 feet
 C - Wet land construction right-of-way = 150 feet

A.7.4.2.1 Brine Disposal System

The alternative brine disposal route is 3.3 miles longer than the proposed route, but traverses much less marshland (Table A.7-3). The additional cost would be about \$2.3 million. However, dry land would be disturbed as opposed to marshland for the primary route.

This route (Number 5 on Figure A.7-3), would proceed from the dome in a southeast direction along a light duty road for approximately 1 mile. It would then turn almost east following the course of the road for another mile crossing a small canal in the process. It then would leave the road and follow another unimproved dirt road for approximately 1.5 miles and turn due south for 0.5 miles over prairie and then a marsh area for about 0.5 miles. The route would then turn in a slightly southeast direction along the dirt road through prairie, for about 1 mile, and turn due south over 1 mile of prairie along the dirt road, then it would angle in a southeast direction toward another unimproved dirt road 0.5 miles away, crossing marsh in the process. At this point the route would head due south along the unimproved dirt road for approximately 0.5 miles over prairie land. The route would then follow the road through a marsh area for about 1 mile to the northern spoil bank at the ICW. After crossing the ICW and running east along the southern spoil bank for about 1 mile, the route would turn due south, perpendicular to the ICW, across the Salt Bayou and through 2.3 miles of marsh. Finally the route would cross State Route 87 and coastal beach (0.7 miles) before extending into the Gulf of Mexico. The length of this line would be 11.5 miles to the Gulf Coast, or a total of 16.5 miles including the 5 mile extension into the Gulf.

A.7.4.2.2 Raw Water System

The alternative supply pipeline for this system (Number 5 on Figure A.7-3), is identical to the brine route described above but terminates at the ICW. This route would be 7.5 miles in length, and although it is two miles longer than the proposed route, it traverses much less marsh (Table A.7-3).

A.7.4.2.3 Oil Distribution System

The alternative pipeline route for this system is about one mile shorter than the proposed route. This route (Number 4 on Figure A.7-3), would run northeast from the dome along Big Hill Road for about 3.5 miles and then north over prairie for 1.5 miles, until it reaches the southern side of State

Highway 73. It would then turn east and follow the shoulder of the highway for 5 miles. The route would then turn due north for about one mile, following a medium-duty road over prairie land and then turn in a northeast direction over prairie land for approximately 0.75 miles before running into marsh area for 0.25 miles. The route would then cross the Taylor Bayou and continue through marsh for approximately 0.25 miles before crossing a narrow patch of woodland. It would then continue across prairie land approximately 2.5 miles, cross a small canal and State Route 365, and continue on prairie for one mile. At this point the route would cross the Hillebrant Bayou with marsh on either side. Out of the marsh area, the route would proceed across prairie land for 4 miles, run along an oil tank field, cross West Port Arthur Road and the Southern Pacific Railroad track, and continue 2 miles across prairie land. It would cross State Route 69, 96, 287 and Port Arthur Fresh Water Canal. Then turning due north 0.5 miles over dry land and proceeding in a northeast direction, crossing State Route 347 and Kansas City Southern Railroad track, it would also pass through the residential section of Central Gardens. The route would continue for approximately 0.3 miles through McFadden residential area and a narrow area of vegetation and marsh, then change to a southeast direction for approximately 0.3 miles before crossing between two manmade water bodies. The route would continue 2.5 miles through dry river bank, running parallel with the McFadden Bend Cutoff, for approximately 1.7 miles and the Smith Bluff Cutoff for the remaining 0.8 miles, ending at the Sun Oil Terminal.

The important factor in considering this alternative, is that it traverses more undeveloped land than the proposed route, whereas the proposed route tends to follow existing roadways and existing pipelines to a greater extent which usually results in fewer ecological impacts but may be more disruptive to the public during construction.

A.7.5 Construction Techniques

A.7.5.1 Road Construction and Other Grading

Big Hill dome is on high and dry land, presenting little or no difficulty in road construction. Roads to the site already exist, and approximately 2 more miles of road would be needed for access to wellheads.

Access to the water intake structure would depend on which route is used (see Section A.7.4). The dryland route would require a minimal amount of grading and graveling. The intake station located on the ICW would be accessible by

canal, requiring only a dredged sump of 100 to 200 cubic yards. The spoil would be deposited on disposal banks designated for the ICW maintenance dredging.

The central plant area would require very little clearing and no land fill. Earth dikes would be built around all surface tanks with the capability of containing the entire volume of the tank. The earth removed while constructing the two 120,000 barrel ponds would be used for dikes along the pond perimeters, and also for dikes around the surface tanks. Dikes would be five feet high and require 20,800 cubic yards of earth at this site. The earth removed while constructing the ponds would amount to 50,000 cubic yards, about half of which would be built up around the perimeter since the water level would be above ground level. The remainder of the earth required for tank dikes would be obtained from surface grading near buildings.

A.7.5.2 Pipeline Construction Techniques

For the pipeline routes presently planned, three methods of pipeline construction would be required as discussed in Section A.4.5.2. Conventional dryland methods would be used in areas north of the dome. South of the dome, toward the gulf, all three methods of construction would be employed due to the marsh areas around the ICW. When crossing any navigable body of water, hydraulic or bucket dredges are used to dig a channel in which to lay the pipe.

A.7.6 Development Timetable

According to present plans, construction of the site facilities, pipelines, and external facilities would be accomplished during the first 5 months. Drilling the storage wells and brine disposal wells would begin from month 1. After 4 months, leaching should begin in the first caverns, taking 38 months to complete. After leaching, the caverns could be filled at faster rates but the fill process is now planned for a 28 month period (see Table A.7-4).

A.7.7 Operation

These procedures have previously been discussed in Section A.4.7. Emergency withdrawal remains at 150 days, and thus requires a withdrawal flow rate of about 667,000 barrels/day for this 100 million barrel site. The refill rate would be a constant 117,000 barrels/day requiring about 28 months to completely refill the site.

Table A.7-4 Timetable for Construction and Fill

<u>Month Period</u>	<u>Fill Rate (MB/D)</u>	<u>No. of Months</u>	<u>Cum. Storage (MMB)</u>	<u>Phase of Development</u>
1-5	0	5	0	Site preparation
2-19	0	18	0	Drill and complete 12 wells
4-42	0	38	0	Initial leaching
42-70	117.0	28	100	Initial fill

A.8 SUMMARY

The expansion of the ESR facilities proposed at the West Hackberry dome would provide 150 million barrels of additional storage capacity. The same pipeline to the Sun Terminal for oil distribution and the same raw water intake system the ICW would be used for the SPR expansion facility as planned for the ESR development. Brine disposal for the expansion facility would be by pipeline to the Gulf of Mexico. The additional storage wells would be located on dry land.

As an alternative site for development, the Black Bayou dome would provide 150 million barrels of storage capacity. The distribution pipeline from West Hackberry to Sun Terminal, as being constructed for the ESR development at West Hackberry, would be used with a 2.7 mile pipeline connection from the Black Bayou site. Raw water supplies would be available on site from Black Bayou channel. A 20-mile brine disposal pipeline to the Gulf of Mexico would be required. Since the dome is overlain by marsh, the storage wells would be drilled from barge mounted rigs with wellheads supported on permanent platforms.

The Vinton Dome, which would provide 50 million barrels of storage capacity, is another alternative site. The distribution pipeline from West Hackberry to Sun Terminal, as being constructed for the ESR development at West Hackberry, would be used with a 7.5 mile pipeline connection from the Vinton site. Raw water would be supplied from the Vinton Drainage Canal via a 2.25 mile pipeline. Brine disposal would be by a deep well injection system. The storage site would be located on dry land.

Another alternative site, Big Hill Dome, would provide 100 million barrels of storage capacity. A new 27 mile pipeline would connect the site to the Sun Terminal for oil distribution. Raw water would be piped from the Intracoastal Waterway 5.5 miles south of the site. A 13.2 mile brine disposal pipeline extending into the Gulf of Mexico would be required. The storage wells would be located on dry land.

A summary table of the primary and alternative sites and their proposed systems components is shown in Table A.8-1.

Table A.8-1 Primary and Alternative Sites - Summary Table

	<u>WEST HACKBERRY</u>	<u>BLACK BAYOU</u>	<u>VINTON</u>	<u>BIG HILL</u>
<u>LOCATION</u>				
County or Parish	Cameron, La.	Cameron, La.	Calcasieu, La.	Jefferson, Tex.
Nearest town	Hackberry, La.	Vinton, La.	Vinton, La.	Port Arthur, Tex.
Population	1,300	3,000	3,000	57,370
Distance to dome (miles)	4	12	3	20
<u>GENERAL</u>				
Area of salt (acres, -2000 ft)	1,750	800	240	507 (382 usable)
Depth to salt (feet)	1,960	1,700	1,030	1,600
Thickness of caprock (feet)	525	500-700	419	1,400
Terrain of storage site	high dry land	marsh	dry land, lake	high dry land
Present land use	grazing, brine production and product storage, peripheral oil field	peripheral oil fields	grazing, peripheral oil field	product storage, peripheral oil field
<u>PROPOSED FACILITY</u>				
Planned storage capacity (mmb)	150 (210 total*)	150	50	100
Estimated storage capacity of dome (mmb)	710	400	120	250
No. of wells planned	15 (for 150 mmb)	15	6 (4 @ 10 mmb, 2 @ 5 mmb)	12 (8 @ 10 mmb, 4 @ 5 mmb)
Storage site land Req. (acres)	160 (for 150 mmb)	230	60	230

*Includes 60 mmb of ESR capacity at West Hackberry.

Table A.8-1 (Continued)

	<u>WEST HACKBERRY</u>	<u>BLACK BAYOU</u>	<u>VINTON</u>	<u>BIG HILL</u>
<u>LOCATION</u>				
<u>RAW WATER SYSTEM</u>				
Source	Intracoastal Waterway	Black Bayou	Vinton drainage	Intracoastal
Average design rate (gpm)	30,000	30,000	10,000	20,000
Length of pipeline (miles)	4.25	0.7	2.25	5.5
Permanent R.O.W. (acres)	25.6 System part of ESR	None (Onsite)	13.5	33
<u>BRINE DISPOSAL SYSTEM</u>				
Method of disposal	Gulf of Mexico	Gulf of Mexico	10 injection wells	Gulf of Mexico
Average design rate (gpm)	33,300	33,300	11,100	22,200
Length of pipeline (miles)	17.8**	20**	4.45	9.2***
Permanent R.O.W. (acres)	108**	121**	27	57***
NOTES:	Route crosses Sabine Wildlife Refuge	Route crosses Sabine Wildlife Refuge	ROW includes well connections and wellheads	

** Does not include 7.0 miles into Gulf.

***Does not include 4.0 miles into Gulf.

Table A.8-1 (Continued)

	<u>WEST HACKBERRY</u>	<u>BLACK BAYOU</u>	<u>VINTON</u>	<u>BIG HILL</u>
<u>LOCATION</u>				
<u>DISTRIBUTION SYSTEM</u>				
Terminal	Sun Terminal/Texoma	Sun Terminal/ Texoma	Sun Terminal/ Texoma	Sun Terminal/ Texoma
Average design rate (bbls/day)	1.4 million*	1.0 million	334,000	667,000
Pipeline system	Same as ESR	Connect to ESR	Connect to ESR	New pipeline construction
New pipeline const. (miles)	0	2.6	7.5	27
Permanent R.O.W. (acres)	0	16	46	144
NOTES:	Pipeline constructed during ESR	Laid in bottom Black Bayou	Follows existing ROW	Follows existing roads and pipeline ROW
Total new land area (acres)	336	410	150	715
Projected time for completion	50 mos.	48 mos.	48 mos.	48 mos.
Projected cost of facility const. (millions of dollars)	189**	207	86.3	130

*Includes 60 mmb of ESR capacity at West Hackberry

**For 150 mmb of SPR expansion.

APPENDIX B

DESCRIPTION OF THE ENVIRONMENT

B.1 INTRODUCTION

This chapter contains a description of the regional environment of the proposed salt dome site, West Hackberry, and the environment of the three alternate sites - Black Bayou, Vinton and Big Hill. Regional geology, water environment, climatology, air quality, ecosystems, natural and scenic resources, archaeological and historical resources, and socioeconomic characteristics are discussed. The environmental setting of the sites, the crude oil distribution systems, brine disposal systems, and the displacement/leaching water systems are also discussed.

B.2 REGIONAL ENVIRONMENT

B.2.1 Land Features

B.2.1.1 Evolution of Salt Domes

There are nearly 500 salt domes (Jirik and Weaver, 1976) in the Gulf Coast region of the United States and Mexico. The salt in these domes was originally deposited in a broad shallow sea during Upper Triassic to Lower Jurassic time (see Figure B.2-1, Geologic Time Scale).

Salt deposition generally occurred in horizontal beds; however, often there were local topographic highs due to irregularities in the surface under the salt, to post-depositional salt flow, or to differential rates of salt deposition in isolated bays or lakes. Eventually the salt became buried beneath thousands of feet of fluvial and marine sediments.

According to widely accepted theory salt dome growth is initiated and maintained by a process of isostatic adjustment (Halbouty, 1967 and Kehle, 1968). This process occurs when a mass of lower density rises to compensate for the sinking of a mass with greater density. Salt has an average density of 2.164 grams per cubic centimeter, whereas, the average density of the sediments before compaction overlying the salt can range from 1.6 to 2.3 grams per cubic centimeter (Krumbein and Sloss, 1963). Dickenson (1953) indicates that approximately 4,000 feet of uncompacted but unconsolidated sediment is required to exceed the density of salt. As additional sediments are deposited the average density of the sediment column increases because of compaction and overburden weight below 10,000 feet to a maximum of approximately 2.4 grams per cubic centimeter (See Figure B.2-2).

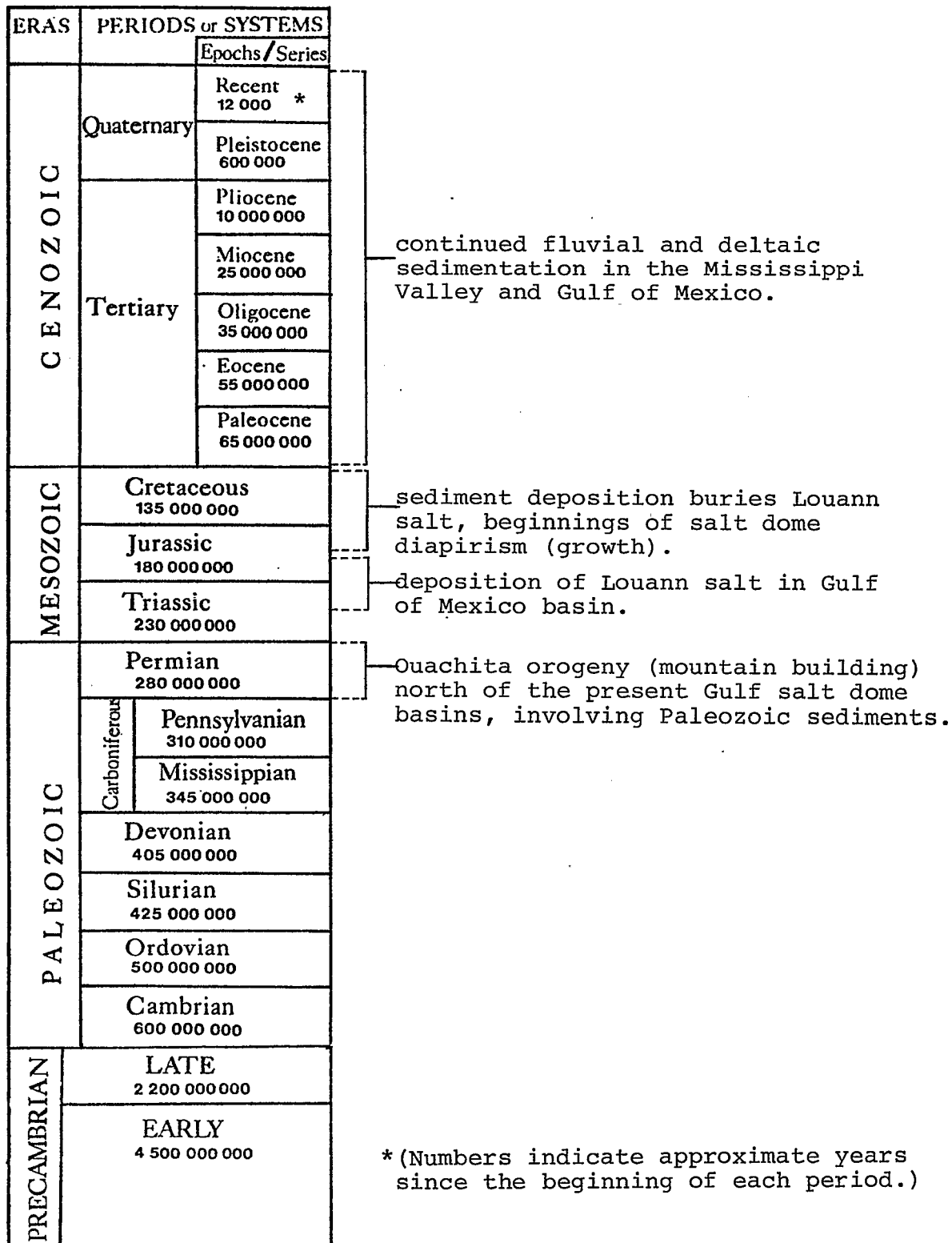

Figure B.2-1 Geologic Time Scale

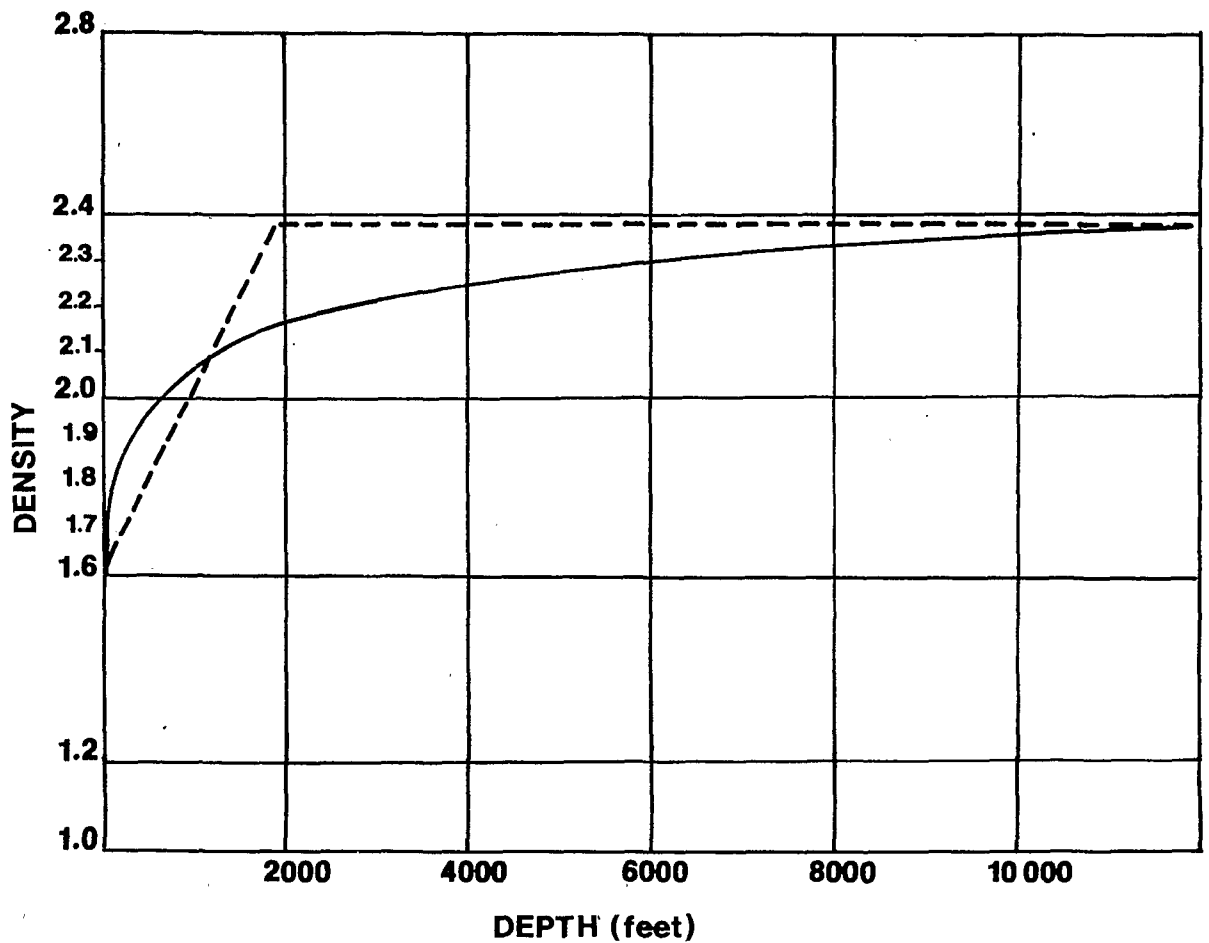

Figure B.2-2 Density of Gulf Coast Shales versus depth of burial

SOURCE: Kehle, 1968 (after Dickenson, 1953).

----- Rate of compaction of sediments.

_____ Average density of sediment column
due to compaction and overburden
weight.

The density difference between the salt and 4,000 feet of sediment overburden must be compensated for by the salt flowing upward. Salt behaves as a viscoelastic material when under pressure; therefore, when a force is exerted on the salt it will flow toward an area of least resistance; perhaps laterally at first, but eventually it will rise vertically. The 'highs' on the irregular salt surface were probably the areas of initial vertical salt movement because of the relative difference in overburden weight compared to the deeper low areas.

As the salt stock rises it begins to push overlying sediments slightly upward. Due to their elasticity they at first stretch, but eventually faulting occurs and sediment blocks are either tilted and pushed to the side or displaced vertically ahead of the salt dome piercement. Smith and Reeve (1970) state that this piercement can occur contemporaneously with the deposition of sedimentary beds or post-depositionally.

As stated later in the discussion of regional geology (Section B.2.1.2), salt dome growth is maintained by continuous deposition of sediment. Another possible mechanism for maintaining or reinitiating the movement of domes that have arrived at a position of relative equilibrium with surrounding sediment was proposed by Halbouty and Hardin (1956). They theorized that the mounded material displaced vertically by the rising salt was subject to erosion; the combined effect of reduced weight immediately above the dome and increased weight above the dome flanks where the sediment was redeposited was enough to maintain or reinitiate movement.

The rate of salt dome growth throughout geologic time is open to speculation, and whether domes are moving today is still being investigated. A report by Netherland, Sewell, and Associated (1976) states that for the last 50 million years the rate of salt dome movement for domes in the Northeast Texas salt dome basin was approximately .006 mm/year on the average. This rate of movement is equivalent to four feet every 200,000 years. Rates during the time of most rapid movement, the Upper Jurassic, are postulated to be as high as 0.153 mm and 0.20 mm per year during Upper Cretaceous. If these rates are accurate even to within an order of magnitude, the implication to the strategic petroleum program is that salt dome movement is extremely slow and would not threaten cavern integrity.

Another important element of salt dome evolution is the formation of cap rock. Cap rock is a mantle of rock, usually well compacted by the weight of overlying sediments, which is of variable thickness and generally lies directly over a salt dome. Cap rock is the accumulation of insoluble

residues of the dissolution of salt as the dome rises through water saturated sediments. The cap rock generally bears no relation to the surrounding sediments except for a relatively thin layer of calcite or pyrite cemented sediments on its margin. The calcite comes from the sediments and often replaces cap rock minerals forming what is known as false cap rock.

Kupfer (1963) states that the average anhydrite content of Gulf Coast domes is less than 3 percent. Halbouty (1967) and Taylor (1938) have indicated that anhydrite is by far the most common insoluble residue of salt domes. It comprises about 99 percent of the insoluble residues (Taylor, 1938). This indicates that the Gulf Coast salt domes are nearly pure salt (NaCl). Other minerals include: gypsum, dolomite, pyrite, calcite, quartz, sulphur, iron minerals, celestite, and barite.

The relative thickness of the mineral zones of cap rock found in Gulf Coast domes is not indicative of the percent composition of the insoluble residues of the parent salt, because of extensive replacement and alteration of the original cap rock minerals. Calcite commonly replaces most minerals except halite (pure salt) and anhydrite. However, anhydrite is altered to gypsum by ground water which circulates through fractures in the cap rock.

Cap rock can range from extremely dense to highly fractured. Fractures can remain open allowing free flow of water, or these fractures can be filled by secondary mineral deposition and infiltration of surrounding sediments. Fractures in the cap rock form as the salt rises. This process is similar to the stretching and faulting of sediments that characterize and accompany salt dome piercement.

Cavities which allow circulation of ground water are common in cap rock and in some cases they contain oil and gas. Saline or hydrogen sulfide springs originating in the cap rock can indicate communication between cap rock and the surface. Taylor (1938) gives an account of surface seepage of grout in a rock quarry one quarter of a mile away from where it was forced into a well drilled through the salt anhydrite cavity at Winnfield Dome, Louisiana. Other accounts of free flow through the cap rock are also given by Taylor (1938).

B.2.1.2 Geology

B.2.1.2.1 Geologic History

The Gulf Coast salt dome basin of the United States and Mexico is among the most extensive salt basins in the world. This major salt basin underlies most of the Gulf of Mexico, Mississippi, Louisiana, Texas; Southeastern Veracruz and Western Tabasco, Mexico; and Cuba. The basin in the southern United States and Mexico is Triassic to Jurassic in age, and in Cuba it is Cretaceous (See Geologic Time Scale Figure B.2-1). The United States Gulf Coast basin has five sub-basins which were areas of maximum salt deposition. These sub-basins include:

- o The East-Central Louisiana Mississippi Interior Basin
- o The Northern Louisiana Interior Basin
- o The East Texas Interior Basin
- o The Texas-Louisiana Coastal Basin
- o The Rio Grand Basin.

Separating these sub-basins are positive structural features including: the Llano uplift, the San Marcos Arch, the Sabine uplift, the Monroe uplift, and the Jackson Dome (See Figure B.2-3). Both the basins and the positive features pre-date salt deposition; therefore, when salt deposition began, the greatest accumulation occurred in the sub-basins. Only later was it possible for salt deposition to occur over the "highs." Present salt thickness over the highs is probably not a good indicator of the original thickness of salt deposition that occurred there, because of the possibility that the salt flowed from these areas into the basins. This is evidenced by the rather thin layer of salt overlying these positive features and the great salt thickness in the basins (Halbouty, 1967). The flow of salt may also contribute to the irregularity of the salt surface which as indicated in the discussion of salt dome evolution may be important in initiating individual dome growth.

Most interior Gulf Coast salt domes are found in the three interior sub-basins. Although the salt in the sub-basins is contemporaneous with the salt in the coastal salt dome basin, Hanna (1959) and Andrews (1960) postulated that after burial the interior basin domes developed before the coastal domes. Andrews (1960) assumed the existence of a relatively low relief ridge separating the interior and coastal salt deposition areas. Upper Jurassic and lower Cretaceous sediments were deposited in a shallow nearshore environment overlying the interior basins. Subsidence occurred at approximately the same rate as sediment accumulated until near the end

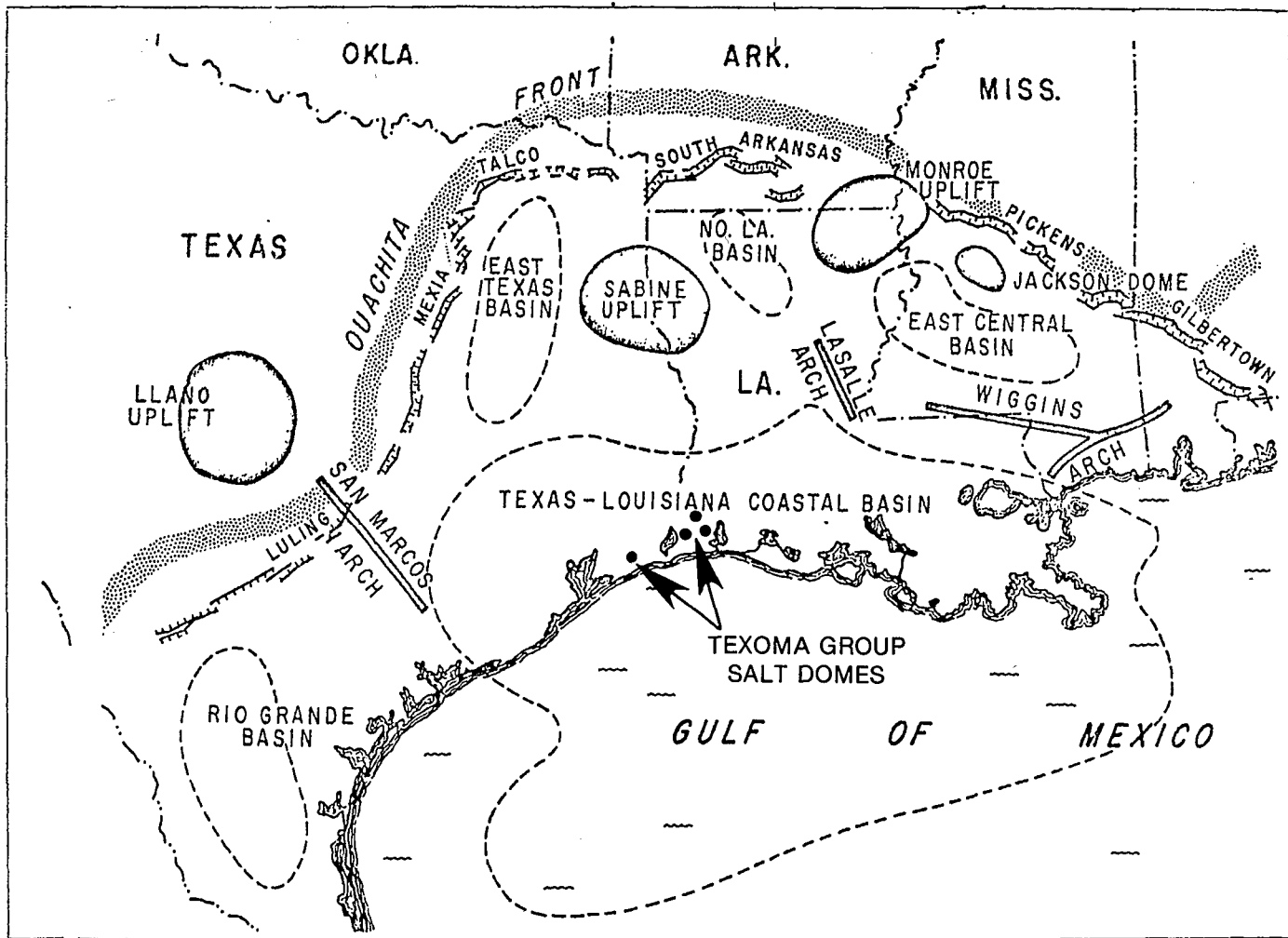

B.2-7

Figure B.2-3 Diagrammatic map outlines the major structural features of the U.S. Gulf region including the five salt dome basins and their relationship to positive elements. Salt-controlled structural features are located in the salt dome basins and are enclosed within dashed lines. The remainder of the area shown is part of the evaporite basin of deposition but in these areas the salt source layer is less thick and no salt structures are known to exist. (Halbouty 1967)

of lower Cretaceous time when sediment was deposited in what is now the coastal salt dome region. From then on, subsidence proceeded as sediment accumulated in both areas. The greater depth of Mesozoic sediment in the interior basin initiated salt dome growth long before sediment depths were sufficient to initiate dome growth in the coastal area.

As the ancient Mississippi River Delta grew farther south of the interior region, relatively more sediment was deposited in the coastal dome area than in the interior region. Without continued sedimentation acting as the driving force, the growth rate of interior salt domes decreased* while the coastal domes continued to grow. A similar cycle is now being completed in the coastal dome area. Today the area of maximum sediment deposition is seaward of the coastal domes of Texas, Louisiana, and Mississippi. Therefore, just as the interior dome growth rates decreased when the maximum sediment deposition occurred south of the interior basin, it is reasonable to assume that since the maximum sediment deposition occurs south of the coastal domes, then the growth rate of coastal domes is decreasing or in some cases may have stopped.

B.2.1.2.2 Stratigraphy

The stratigraphic column represents a nearly continuous record of sedimentation since the deposition of the Louann salt. Sediments are generally unconsolidated to poorly consolidated at depth. The alternating sequences of gravels, sands, silts, and clays correspond to the advance and the inland retreat of ancient shorelines. Shallow high energy environments are represented by gravels and sands deposited in nearshore environments. As the shoreline retreats, a lower energy environment is conducive to deposition of smaller grained silts and clays. The sediments attain thicknesses of approximately 20,000 feet in the interior basins and 35,000 feet in the coastal basin (Martinez, 1976, Hales et al., 1970).

Younger sediments dip only a few feet per mile to the south. However, older and deeper sediments dip more, and off the edge of the shelf sediments dip as much as 600 feet per mile (Carsey, 1950).

*Martinez (1976) suggests that the Northeast Texas salt domes have reached a state of quiescence. There is evidence from cores that there is a progressive decrease in dip of beds tilted by salt dome growth from the older to the younger Tertiary sediments above the interior basin.

B.2.1.2.3 Geologic Structure

The interior and coastal salt dome basins are aligned parallel to the axis of the Gulf Coast Geosyncline, which is offshore and parallel to the shores of Mississippi, Louisiana and Texas. Continued subsidence and sediment deposition are the dominant processes which are responsible for and continue to influence present structural configuration. Subsidence occurs in response to the deposition of sediments delivered to the Gulf by rivers and streams, the most notable being the Mississippi. The rate of subsidence is nearly equal to the rate of sediment deposition.

While the once horizontal sediments are depressed in the Gulf basin, the same sediments deposited further inland are not subsiding as rapidly. Therefore, between these two points there is a stretching of the sediments which, in geologic time, has often resulted in normal faulting throughout the Gulf Coast Region. The unconsolidated nature of the sediments, however, is more subject to elastic behavior than brittle failure. For this reason, in a non-geologic time sense the frequency of seismic activity in the Gulf Coast area is low.

A search of seismic records revealed only one earthquake in the Gulf Coast salt dome basins since record keeping was started (about 150 years ago). It occurred on October 19, 1930, with an epicenter located approximately 4 miles southeast of Donaldsonville, Louisiana. A Richter magnitude was not recorded, but on the Modified Mercalli Scale the intensity of the Donaldsonville earthquake was recorded as IV (Earthquake History of the U.S., 1974; modified Mercalli scale appears in Appendix C.)

The San Marcos Arch in Texas and the structural features identified above predate the deposition of Louann salt and effectively confined most salt deposition to separate basins. These features are remnants of Paleozoic mountain-building in the Ouachita belt of Texas, Oklahoma, and Arkansas (Halbouty 1967).

B.2.1.2.4 Geomorphology

The Gulf Coast salt domes lie under a broad portion of the larger Gulf Coastal plain that extends from South Carolina through Florida to Texas and up the Mississippi Valley to Kentucky. In Louisiana and eastern Texas the surface of this plain has a gulfward slope of about 5 feet per mile (Carsey, 1950). Southward the coastal prairies give way to marshes and eventually coastal estuaries. The entire area is dissected by a network of streams, bayous and rivers. There are occasional freshwater and brackish lakes in the hydrologic system.

Two important topographic features of coastal Louisiana and Texas are mounds raised above some shallow salt domes and cheniers which are abandoned beach ridges. The mounds are generally 10 to 20 feet above mean terrain and can cover several acres, but they are not found at all salt domes. The cheniers are roughly parallel to the present Gulf Coast line and they are generally 10 to 20 feet above mean terrain, 150 to 1,500 feet wide and several tens of miles long. They are formed during successive progradations of the shoreline.

B.2.2 Water Environment

The Gulf coastal region of southwestern Louisiana and southeastern Texas is characterized by a complex surface and subsurface hydrologic system. The surface water system consists of an intricate network of rivers, bayous, waterways, and canals linking numerous lakes, ponds, and reservoirs. These are interspersed with extensive marsh and swamp areas. Rainfall is the major source of replenishment in the area and the ultimate recipient of water draining out of the region is the Gulf of Mexico. Through tidal and atmospheric (weather) effects, the Gulf also exercises considerable influence over the entire surface water system.

The subsurface (geohydrologic) water system consists of a series of aquifers* lying one atop another, and aquifers are interlaced with aquitards.** The upper aquifers generally contain fresh water, but with increasing depth, and/or proximity to the Gulf, more saline water is encountered.

* A water-bearing stratum, normally composed of sand.

** A geologic formation of a rather impervious and semi-confining nature which transmits water at a very slow rate compared to an aquifer. Over a large area of contact, however, it may permit passage of large amounts of water between adjacent aquifers.

The surface and subsurface water systems within the region are not totally isolated from one another, but the connections are somewhat indirect and are generally of secondary importance. It is significant to note, however, that in both systems a problem of primary concern is salt water intrusion.

B.2.2.1 Surface Water Systems

As already noted, the surface water system is quite complex. Certain bodies of water, which are of primary importance, are shown in Figure B.2-4. In terms of size and influence The Gulf of Mexico serves as the dominant hydrologic unit in the system. Two sizeable river systems, the Calcasieu and the Sabine-Neches, empty into the Gulf. The Calcasieu system forms the eastern boundary of the region, while the Sabine-Neches lies between the three Louisiana sites (West Hackberry, Vinton, and Black Bayou) and the Texas site (Big Hill), which comprise the Texoma group. A major lake is located near the mouth of each river system. These two lakes, the Calcasieu and the Sabine, serve as secondary reservoirs situated between the river systems proper and the Gulf. Numerous marshes and swamps are located throughout the region. The most extensive marsh system, situated between the Sabine and Calcasieu Lakes, generally coincides with the Sabine National Wildlife Refuge.

The primary manmade water body within the region is the Intracoastal Waterway (ICW). The ICW is located 5 to 20 miles inland from the Gulf, running roughly parallel to the coastline. The proposed site, West Hackberry and one alternate site, Black Bayou, are located south of the ICW; while the other two alternatives, Vinton and Big Hill, are located to the north of the waterway.

Rainfall in the region is relatively heavy. At Lake Charles an annual rate of 55.4 inches/year was measured during the period from 1967-1969, while at Port Arthur during the same period the average rate was 47.2 inches/year (U.S. Department of Commerce, 1967-1969). For the entire region the average rate was 52.7 inches/year. Rainfall is not only heavy, but also intense. The intensity of rainfall, combined with the level of precipitation, is normally expressed in terms of the rainfall factor, R. The value of this factor for the region is 350, which represents the maximum value for rainfall within the continental United States (U.S. Department of Agriculture, 1975).

The surface water system is extensively used for a variety of purposes throughout the region. Heavy industrial activities in the vicinity of Lake Charles, Orange, Port Arthur, and Beaumont have resulted in considerable use of the surface water for transportation. These same industries utilize a sizeable amount of fresh surface water in their operations,

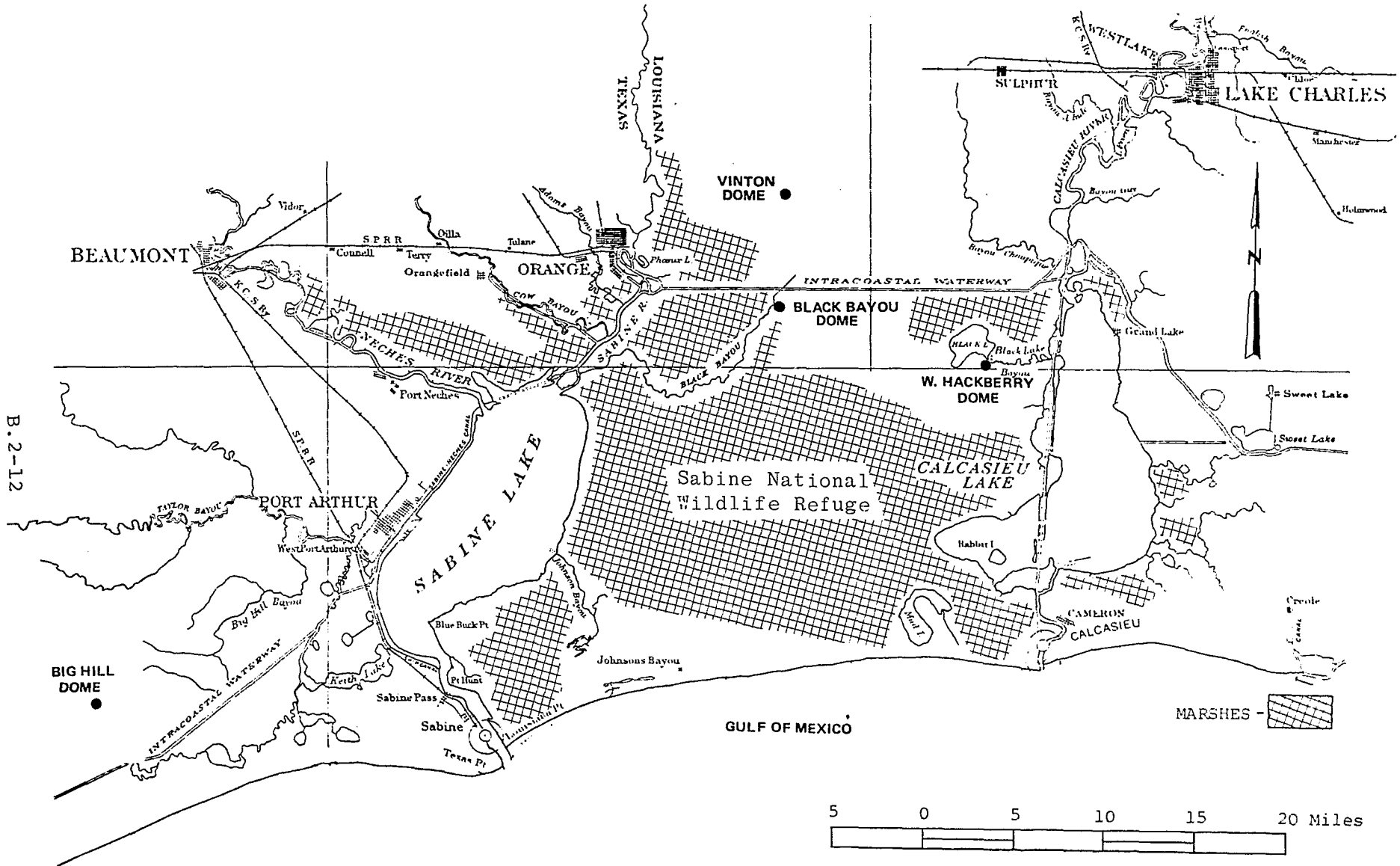

B.2-12

Figure B.2-4 Regional Surface Water Bodies

and also discharge large volumes of waste water into the system. Commercial fishing represents a significant source of income in the region. Rice farming occurs to the north of the ICW. Some surface water is used for consumption by livestock and for irrigation of crops but little if any is used for human consumption. Many bodies of water serve as recreation sites for boating, fishing, and swimming. In addition to the preceding types of utilization by man, the surface water system serves as an important habitat for wildlife, as discussed in Section B.2.5.

Water quality within the region varies considerably from site to site. Generally the surface water is soft* with an intermediate pH level.** Brackish waters are generally more common between the Gulf and the ICW while fresh waters occur further inland beyond the ICW. The tendency for salt water from the Gulf to intrude into freshwater areas during periods of low river flow, constitutes the single most important water quality problem in the region. Closely related to the salt water intrusion problem is the consumption of surface water by industry and agriculture and subsequent release of various contaminants by the same or related activities. Both the water and sediment of portions of the Calcasieu and Sabine-Neches River systems appear polluted as a result of such releases.

In describing the existing water quality environment it is useful to identify any water quality parameter which appears, for some reason, to be too high or low. In order to make such an identification the available measured water quality and sediment quality data must be compared with appropriate standards and criteria. Some confusion exists concerning the distinction between and the proper usage of the terms standards and criteria. For purposes of organization and clarity in this document the term standard will be used to refer to any enforceable water quality regulation, such as established by a state. The term criterion will be used to refer to any recommended limit placed on a water or sediment quality parameter. As discussed in Appendix D, criteria are

* The concept of hardness or softness comes from water supply practice. It is measured by soap requirements for adequate lather formation and as an indicator of the rate of scale formation in hot water heaters and low pressure boilers.

** The pH of natural waters is a measure of acid-base equilibrium achieved by the various dissolved components, salts and gases.

not enforceable. If a measured water quality parameter falls outside of the prescribed standard it will be described as violating the standard. When a measured parameter lies outside of an applicable criterion it will be referred to as exceeding the criteria. In certain cases because of (1) detection of threshold limitations for the measured data, or (2) the absence of applicable standards or criteria, or (3) ambiguities in existing standards or criteria, a precise judgment is not possible. In such cases, if there is good reason based on the experience of the water quality analyst to expect some particular water or sediment quality problem the appropriate parameter will be described as posing a possible problem.

B.2.2.2 Subsurface Water Systems

In the coastal zone of southeastern Louisiana within Calcasieu and Cameron Parishes fresh ground water* occurs only in the upper 1,000 feet of the sedimentary sequence. Slightly saline water** is present to a depth of more than 2,000 feet in northern Calcasieu Parish, but generally occurs within 1,000 feet of the surface in Cameron Parish.

In order of increasing depth and geologic age, the Chicot, Evangeline and Jasper aquifers contain fresh water northward from central Calcasieu Parish. South of this point, fresh and slightly saline water is limited to the Chicot aquifer as shown in Figure B.2-5. The Chicot aquifer, like other sedimentary beds in the region, was deposited parallel to the coast as a gulfward-thickening wedge of sand, gravel, silt, and clay. The individual sand beds composing the Chicot aquifer are generally several feet thick and occur over several miles. Jones (1956) divided the Chicot aquifer into three units designated by their depth of occurrence in the Lake Charles areas as the "200-foot", "500-foot", and "700-foot" sands. Clays separating these sands are not continuous and allow ground water to flow from one sand to another, depending on the head differences within the aquifers (Harder et al., 1967).

The correlation between the aquifers in the eastern portion of the Texas coastal plain and the aquifers already described in Louisiana is shown in Table B.2-1. In southwestern Louisiana the middle sands of the Chicot aquifer are the primary aquifers. In Texas, the Upper Chicot is of primary importance due to the shallower occurrence of fresh water in this area of the Texas coast.

* Fresh ground water is defined here as having a dissolved solids content of 0-1000 mg/l.

**Slightly saline water is defined here as having a dissolved solids content of 1000-3000 mg/l.

B.2-15

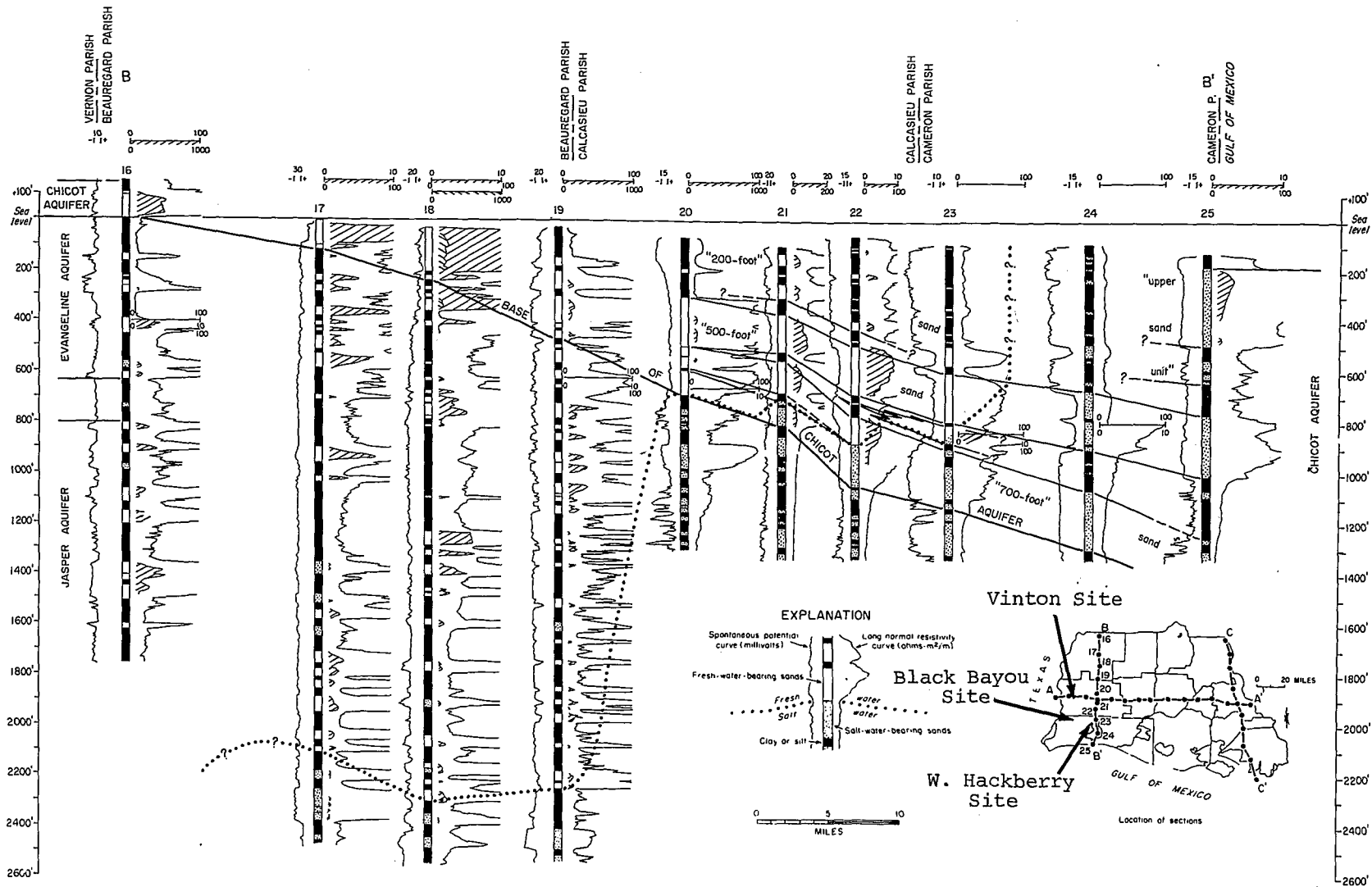

Figure B.2-5 Geohydrologic Section From Northern Beauregard Parish to Southern Cameron Parish, Louisiana

TABLE B.2-1 CORRELATION OF LOUISIANA AND TEXAS AQUIFERS

SYSTEM	SERIES	AQUIFERS	
		Louisiana	Texas
Quaternary	Holocene		Upper Chicot
	Pleistocene	Shallow Chicot "200 foot" "500 foot" "700 foot"	Lower Chicot
Tertiary	Pliocene	Evangeline	Evangeline

Fresh to slightly saline ground water occurs as deep as 1,500 feet in some areas of Jefferson County, Texas, but at the coast the wedge of fresh water is reduced to less than 100 feet thick. Fresh water in the Chambers-Jefferson County area is limited to the upper Chicot aquifer (Wesselman, 1973). This aquifer is equivalent to the shallow Chicot of southwestern Louisiana (Harder, 1960). In the eastern and western portions of the two county area, the upper Chicot is divided into two distinct sands by an intervening aquitard. In the center of the area the upper Chicot behaves as a single aquifer, particularly where salt domes have pierced the Chicot, creating a vertical hydrologic connection between normally separated sands.

In 1965 (the latest figures available) the total daily ground-water production for Calcasieu and Cameron Parishes of Louisiana was 167 million gallons per day (Harder et al., 1967). About 50 percent of this water was produced in Calcasieu Parish, and about 90 percent of the parish-wide production was divided nearly evenly between irrigation and industrial uses. Municipal use accounted for about 7 percent of the ground water use. The principal center of ground water production is Lake Charles, where water levels in the Chicot aquifer have declined more than 130 feet since the early 1900's.

In southeastern Texas the major centers of ground water pumping are the Baytown area, in extreme western Chambers County; the Winnie area, approximately 6 miles northwest of Big Hill dome; and the Beaumont-Port Arthur area, in extreme eastern Jefferson County. Important local centers of ground water offtake exist at Big Hill and High Island domes (Wesselman, 1973). In Jefferson County, ground water pumpage totaled 4.6 million gallons per day in 1965. Of this total, 0.5 mgd was for irrigation, 1.0 mgd was for municipal use, and 3.1 mgd was for industrial use.

Because of its limited availability, fresh ground water is imported from Orange and Hardin Counties for use in Beaumont and Port Arthur. Further importation of fresh ground water from neighboring counties is probable in the future (Wesselman, 1973).

In the coastal aquifers of southwestern Louisiana the maximum depth of fresh ground water diminishes gulfward. The position of the freshwater-saltwater interface is influenced by natural recharge and discharge conditions and by artificial or "man-made" effects (i.e., ground-water pumping). As a result of pumping at Lake Charles the salt water interface is moving northward at rates between 30 and 200 feet per year (Harder et al, 1967).

In southeastern Texas most of the ground water in Chambers and Jefferson Counties is slightly more saline. Although saline water occurs naturally in the coastal aquifers it is also introduced into the aquifers by dissolution of salt from salt domes. Abrupt changes in the depth of occurrence of fresh water at Barbers Hill, Spindletop, and Fannett salt domes is attributable either to salt dissolution by ground water or to vertical movement of deeper saline waters around these domes.

B.2.3 Climatology and Air Quality

B.2.3.1 Climatology*

The regional climate of the SPR site area including West Hackberry expansion site, Black Bayou, Vinton, and Big Hill, is classified as "humid-subtropical with strong marine influences." Seasonal fluctuations are moderate. Winters are generally cool and clear with occasional periods of overcast. In summer, the days are generally warm and humid with little daily variation. Afternoon showers and thundershowers occur frequently.

The average length of the freezing season at the Hackberry weather station (approximately 6 miles south of the West Hackberry site on Calcasieu Lake) extends from mid-December to mid-February, with typically 4 to 8 days having temperatures of or below 32°F (NOAA, 1973, 1974). In Lake Charles (approximately 22 miles northeast of the West Hackberry site), December and January are the foggiest months, with 8 to 9 days per month of heavy fog restricting visibility to less than a quarter mile (NOAA, 1973-1975). November through May are usually the windiest months, with mean wind speeds of 9 to 10 mph. The monthly percentage of calms (winds less than 2 miles per hour) at Lake Charles and Port Arthur are plotted in Figure B.2.6 which indicates that such conditions occur most frequently during summer and fall. The November through March period is typically the coldest with temperatures averaging in the 50°s. The monthly precipitation averages around 4 inches throughout the year with the exception of the months of July and August when the occurrence of summer shower activity reaches a maximum. The normal rainfall at Hackberry is plotted on a monthly basis in Figure B.2-7. June, July, and August are usually the hottest, wettest, and most humid months with temperatures in the low to mid 80°'s, as seen in Figure B.2-8. Rainfall reaches a monthly maximum of 6.83 inches in July at Hackberry, with the average daily humidity reaching 75 percent during this season. Thunderstorm activity in the area is greatest in July and August with an average of 14 thunderstorm days per month (Trunkline LNG, Co., 1975) compared with the annual total of 70 thunderstorm days (Landsberg, 1969). The monthly distribution of thunderstorms for the Lake Charles area is shown in Figure B.2-9. The annual rainfall in the area is approximately 54

*The following data are not site specific in that the nearest weather monitoring stations are 6 to 20 miles away. Data presented is from the nearest station to West Hackberry.

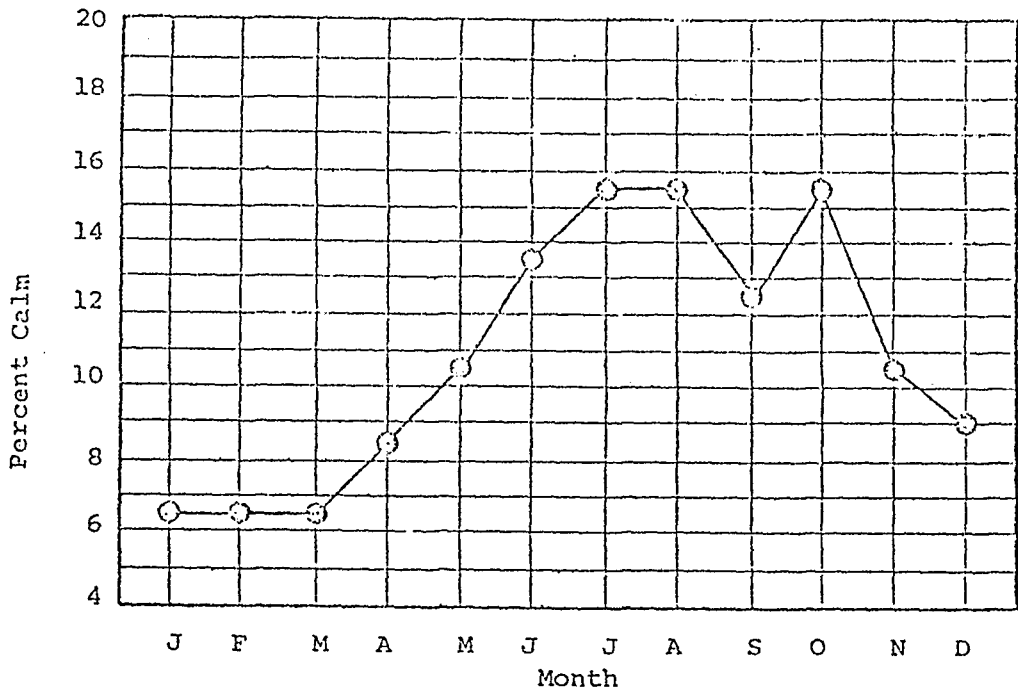

Figure B.2-6 Monthly Percentage Calm at Lake Charles
(Wind Speed ≤ 2 mph)

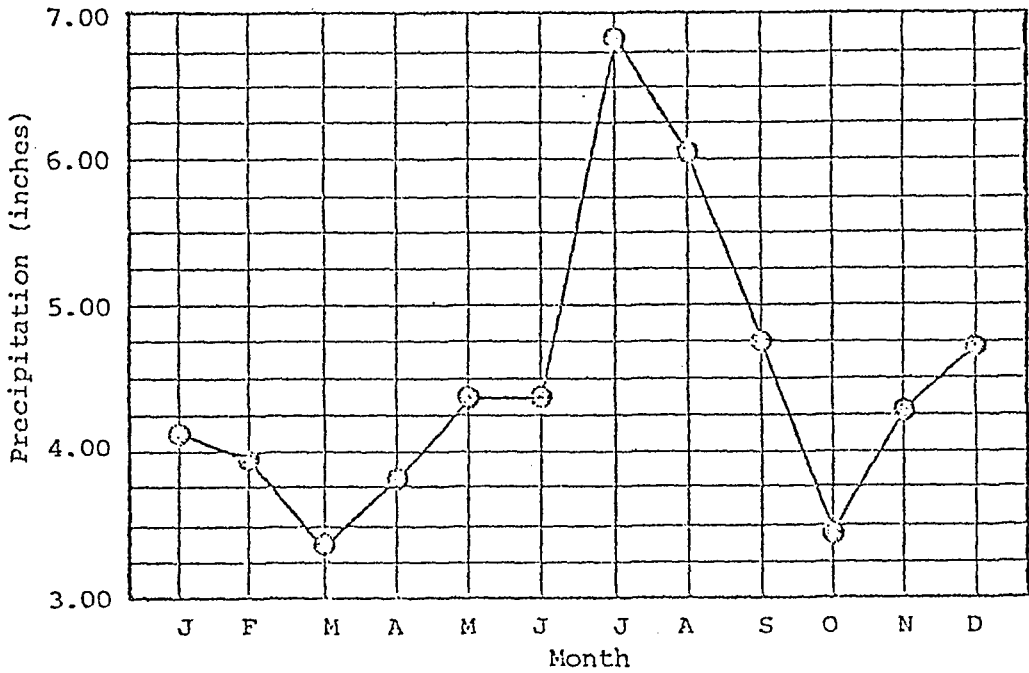

Figure B.2-7 Monthly Normal Precipitation at Hackberry (8 SSW)

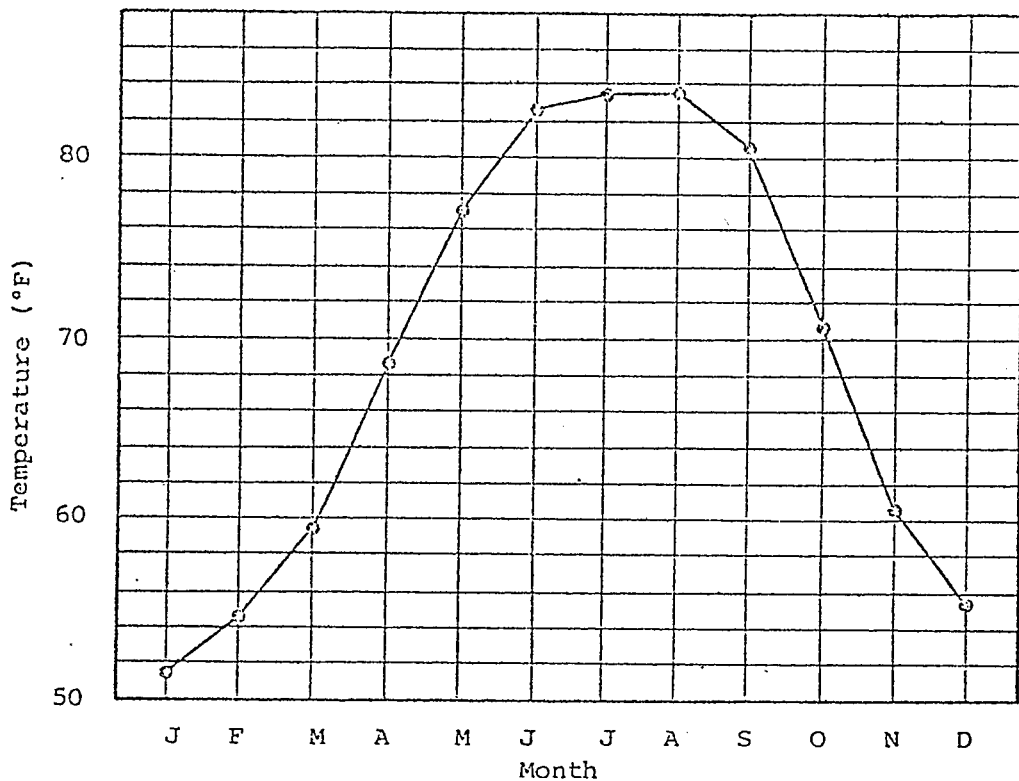

Figure B.2-8 Monthly Normal Temperatures at Hackberry (8 SSW)
 Source: Climatological Data-Louisiana, NOAA Vol. 78, No. 3, 1973 and Vol. 79, No. 13, 1974.

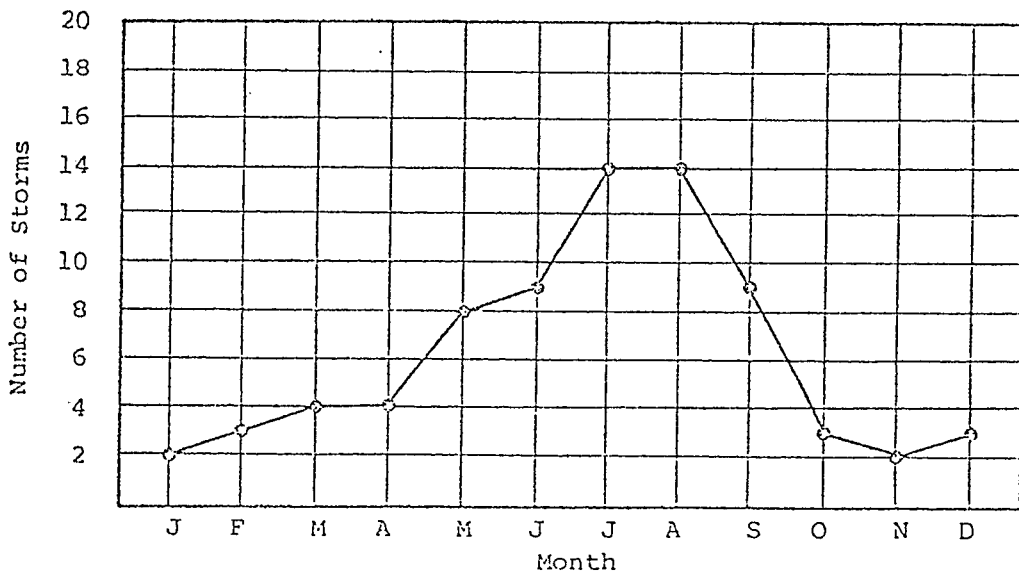

Figure B.2-9 Average Number of Thunderstorms
 Per Month at Lake Charles (1967-1974)
 Source: Local Climatological Data, National Climate Center, Asheville, N.C., 1967-1974.

inches at Hackberry and the annual lake evaporation losses are roughly 50 to 51 inches (NOAA, 1968).

Within the past 20 years, two storms passed through the area with winds 100 miles per hour or greater. These were Hurricane Audrey (25-29 June 1957), which passed west of Lake Charles between Calcasieu Lake and Sabine Lake, and Hurricane Edith (5-18 September 1971), which passed southeast of the area (DOI, 1975). Hurricane Bertha (8-12 August 1957) was a lesser storm (recorded winds less than 100 miles per hour through its path, and passed on a sweep from southeast of Hackberry to just north of Port Arthur (DOI, 1975).

Severe storm statistics for two 50 nautical mile strips (57.6 statute mile strips) of Louisiana coastline adjacent to West Hackberry reveal these details (Simpson, 1971):

Number of Tropical Cyclones Reaching the Mainland 1886-1970*

	West	East
All Tropical Cyclones	12	10
All Hurricanes	7	5
Great Hurricanes	3	1

Number of Years Between Tropical Cyclone Occurrences
(Average for Period 1886-1970)

	West	East
All Tropical Cyclones	7	8
All Hurricanes	12	17
Great Hurricanes	28	85

Risk of Tropical Cyclones**

	West	East
All Tropical Cyclones	14%	12%
All Hurricanes	8%	6%
Great Hurricanes	4%	1%

*Dual numbers represent statistics for the western 50 miles and the eastern 50 miles in sequence of the Louisiana shoreline which are adjacent to West Hackberry.

Definitions:

Tropical Cyclone	39-73 mph.
Hurricane	74-124 mph.
Great Hurricane	>125 mph.

**Risk equals the probability (%) that a tropical storm, hurricane or great hurricane will occur in any one year in a 50 nautical mile segment of coastline.

The nearest wind rose data to the SPR site region are from Port Arthur and Lake Charles and are presented in Figure B.2-10. Figure B.2-11 gives a general profile of the wind rose patterns for the Western Gulf Coast. The annual percent frequency of winds by speed groups for Lake Charles, Louisiana and Port Arthur, Texas show these characteristics:

Wind Speed Groups	Lake Charles (NOAA, 1968)	Port Arthur (NWRC, 1968)
0.3 mph	19%	6%
4-7 mph	31%	
8-12 mph	29%	64%
13-18 mph	17%	
19-24 mph	4%	29%
25-31 mph	1%	1%
32-46 mph	--	--
Mean Speed	8.5 mph	10.1 mph

Eighty percent of the winds in the Lake Charles area and seventy percent in the Port Arthur area are less than 12 mph. Extreme winds at 30 feet above ground with a 50-year recurrence interval are around 95 mph, and with a 100-year recurrence interval, around 100 mph (Thom, 1968).

B.2.3.2 Climatological Factors Affecting Dispersion

Dispersion climatology provides an evaluation of the capability of the atmosphere to disperse airborne effluents in a given geographical region. That capability depends largely on three critical climatological factors: (1) atmospheric stability, (2) mixing height, and (3) the mean wind field within the mixing layer.

B.2.3.2.1 Atmospheric Stability

The dispersive potential of the atmosphere can be categorized into seven stability classes in accordance with a method proposed by Pasquill (1962) and modified by Markett (1966) and Gifford (1969).

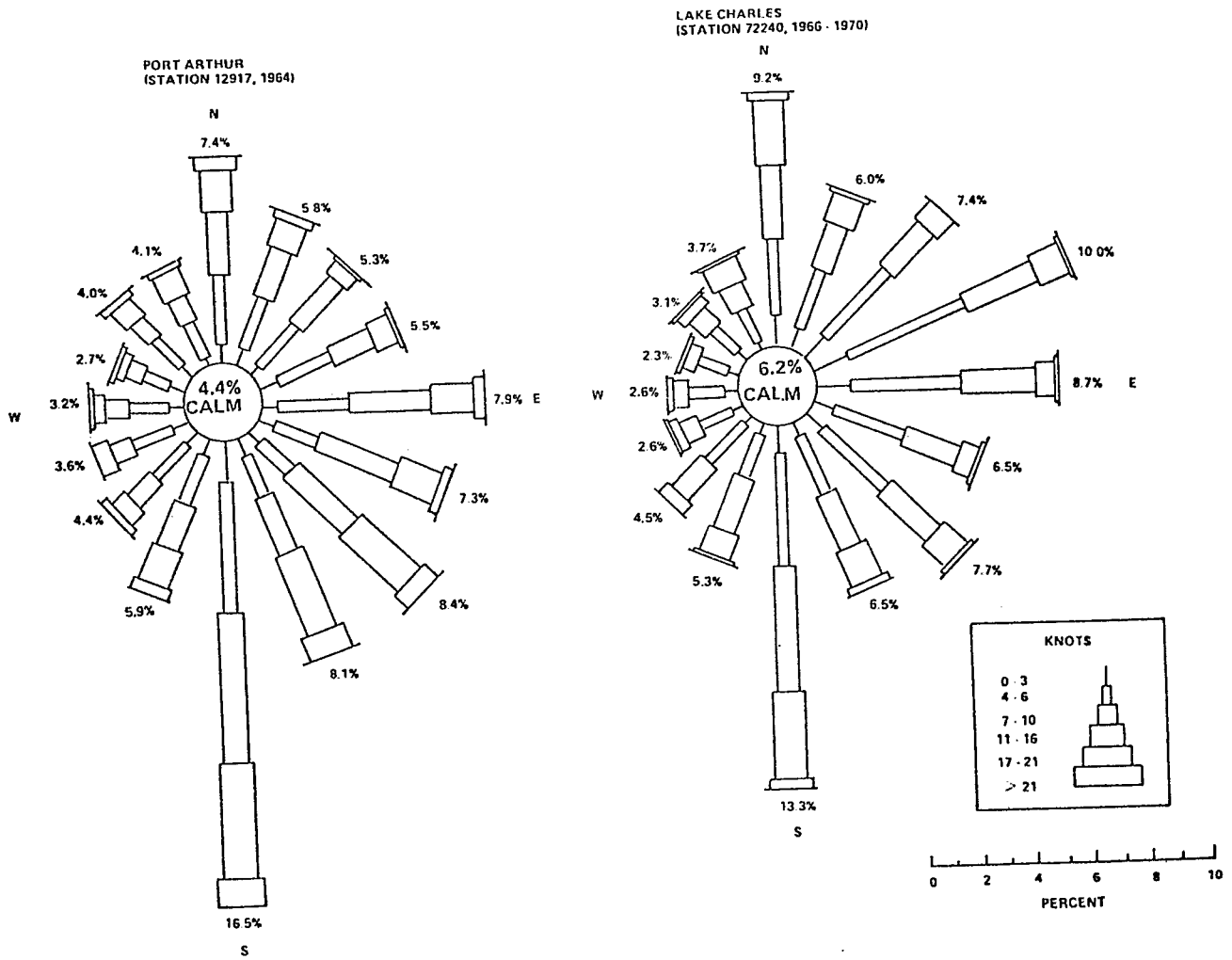
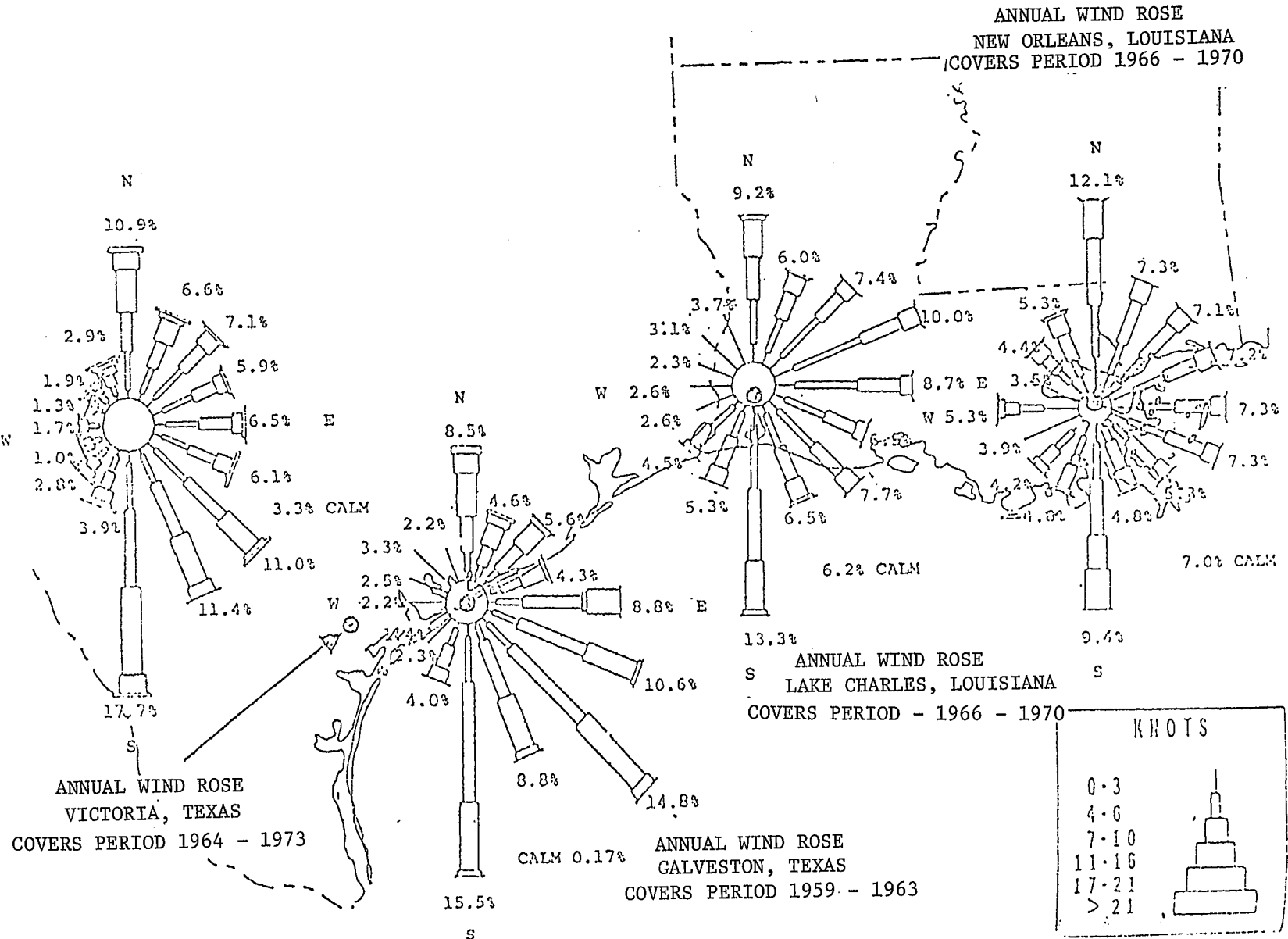

Figure B.2-10 Annual wind rose data for Lake Charles (1966-1970) and Port Arthur (1964)

Figure B.2-11 Annual Wind Rose Gulf Coast



The stability classes are as follows:

- A Extremely Unstable
- B Unstable
- C Slightly Unstable
- D Neutral
- E Slightly Stable
- F Stable
- G Extremely Stable

Table B.2-2 summarizes the annual distribution of atmospheric stability class in terms of unstable, neutral and stable conditions for four weather stations encompassing the Texas-Louisiana Gulf Coast region.

The stability in the lowest part of the atmosphere is dependent primarily upon net thermal radiation and wind speed. Without the influence of clouds, insolation (incoming radiation) during the day is dependent upon solar altitude, which is a function of latitude, time of day, and day of year. When clouds exist, their extent and thickness decreases incoming and outgoing radiation. At night, estimates of outgoing radiation are made by considering cloud cover. The Pasquill classification is based upon ground-level meteorological observations (surface wind speed, cloud cover, and cloud ceiling) and solar elevation data. As a result, the increase in wind speeds with westward progression along the Gulf Coast is reflected in an associated increase in the frequency of well-mixed or neutral conditions. Unstable and stable conditions, however, occur more frequently in the eastern portions of the region. At each station, with the exception of New Orleans, neutral conditions dominate followed by stable and unstable conditions in decreasing frequency of occurrence. At New Orleans, stable conditions occur more frequently. The West Hackberry expansion site, Black Bayou, Vinton and Big Hill are located sufficiently far west along the Gulf coastline that neutral atmospheric stability will occur more frequently than stable or unstable conditions. However, stable, light wind speed conditions comprise an important portion of the annual distribution. Such conditions tend to maximize the ground level impact of surface, non-buoyant emissions while neutral conditions tend to maximize the impact of sources with moderately high release heights. The actual meteorological worst-case scenario for each of the SPR sources will vary as a function of source exit characteristics.

TABLE B.2-2
Regional Distribution of Atmospheric
Stability Class

Location	Annual Frequency (%) of		
	Unstable Conditions ¹	Neutral Conditions ²	Stable Conditions ³
Galveston, Texas	16.0	61.4	22.6
Lake Charles, Louisiana	19.4	40.9	39.7
Baton Rouge, Louisiana	20.0	43.4	36.6
New Orleans, Louisiana	26.0	29.8	44.2

1. Includes Pasquill Stability Classes A, B and C.
2. Pasquill Stability Class D.
3. Includes Pasquill Stability Classes E and F (G not available for above sites).

Pasquill (1962), modified by Marker (1966) and Gifford (1969), has developed a classification of atmospheric stability on a scale of A (extremely unstable) to G (extremely stable).

B.2.3.2.2 Mixing Height

At certain times a stable layer can be found in the atmosphere which increases in temperature from lower to higher altitudes. The term "inversion" is used to describe this situation since air temperature normally decreases with increasing height. There are basically two types of inversions. One is the radiation inversion, which typically forms at night whenever there is little surface wind movement and the sky is clear. It develops as heat is lost from the earth's surface by radiation and the air in contact with the ground is cooled more rapidly than air further above the surface. A temperature inversion is based at the earth's surface and may vary in thickness from a few to several hundred feet. Radiation inversions normally dissipate shortly after sunrise due to heating of the surface.

The other type of inversion is known as a subsidence inversion, and is associated with large-scale high-pressure areas (anti-cyclones). Air moving in the clockwise circulation at higher altitudes in such a system generally tends to sink or subside. As the air subsides, it is heated by compression as it reaches lower heights (higher atmospheric pressure) forming a stable layer aloft. A subsidence inversion layer is often found at heights of several thousands of feet above the earth's surface.

Inversions, in general, restrict the dispersive ability of the atmosphere, and an inversion aloft acts as a barrier to vertical mixing. The layer of air between the earth's surface and the inversion aloft, within which pollutants are mixed by turbulence and diffusion, is called the mixing layer. The height or vertical extent of this layer is defined by the position of a stable layer aloft. This elevated inversion layer, in which the temperature increases with height, derives largely from slow but sustained and widespread subsidence, in which the air is heated adiabatically.*

Mixing heights typically go through a large diurnal variation. At night, in rural locations, the mixing height is usually considered to be zero because surface-based inversions often form which inhibit vertical motion. Sometime after sunrise, an unstable layer will form at ground level and grow in vertical extent in proportion to the degree of insolation. In late afternoon, this layer of vigorous mixing begins to recede. Seasonally, mixing heights tend to be the lowest in fall and winter and the highest in summer.

*Occurring without loss or gain of heat by the substance concerned.

Figures B.2-12 and B.2-13 provide monthly values of mixing height during the morning and afternoon hours, respectively, at four stations along the Western Gulf Coast; Brownsville, Texas (NWRC, 1964a), San Antonio, Texas (NWRC, 1964b), Lake Charles, Louisiana (NWCR, 1964c), and Burrwood, Louisiana (NWCR, 1964d). The data indicate the expected diurnal and seasonal trends. In addition, Burrwood, Louisiana experiences the highest mixing heights during the morning hours with Lake Charles, Louisiana indicating the lowest heights. Burrwood experiences the greatest morning mixing heights due to its location on the Gulf of Mexico, whereby, the surrounding warm Gulf waters inhibit the development of surface inversions resulting in the high average mixing heights during the morning hours. On the other hand, Lake Charles, which is the most representative of four SPR sites, is sufficiently far inland to experience a higher frequency of nocturnal radiational inversions and consequently lower morning mixing heights. San Antonio and Brownsville, Texas experience approximately equivalent morning mixing heights with the actual values lying between the extremes noted for the two Louisiana stations. The four stations experience very similar morning mixing heights during winter with the greatest regional disparity occurring during late summer and early fall.

Afternoon mixing heights as presented in Figure B.2-13 indicate that San Antonio experiences the highest values while Burrwood has the lowest readings. Good agreement exists between the coastal sites at Lake Charles and Brownsville. Burrwood is also a coastal location; however, its position on a peninsula (Mississippi Delta) in the Gulf of Mexico has a moderating effect on mixing height due to the overbearing influence of the surrounding Gulf waters. This influence is reflected in the minor nature of the diurnal changes in mixing height at this location. San Antonio experiences the highest afternoon mixing heights due to the increased convective heating observed at an inland location. Lake Charles and Brownsville experience values of mixing height between the extremes established at the other two stations. Minimum regional disparity for this parameter occurs during late fall and early winter with a maximum occurring during late summer.

Holzworth (1972), has summarized the available temperature sounding data for the contiguous United States and developed seasonal and annual contours of morning and afternoon mixing height. The data are presented for the four SPR sites in Table B.2-3 which follows.

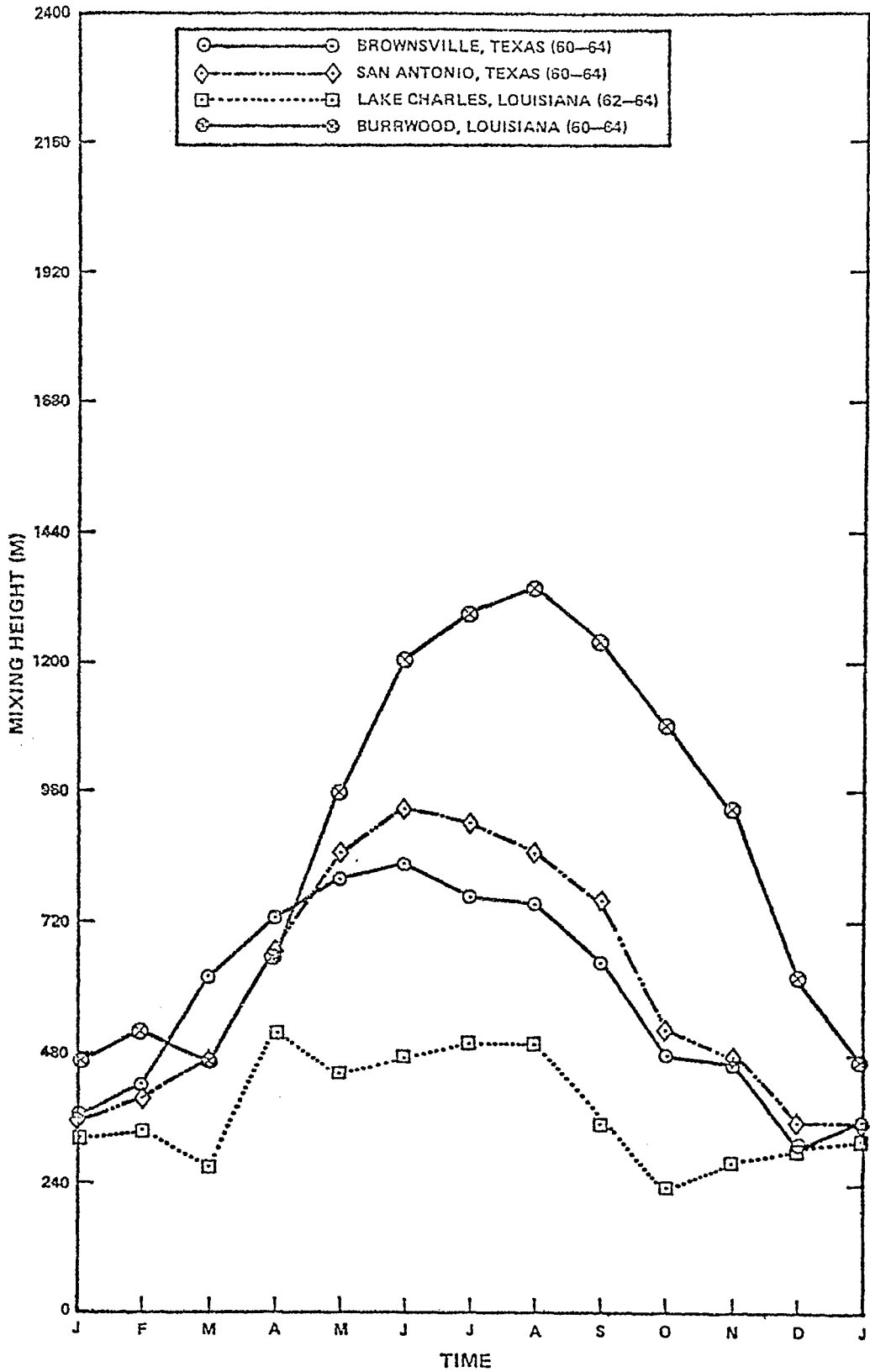

FIGURE B.2-12 MONTHLY AVERAGES OF MORNING MIXING HEIGHT

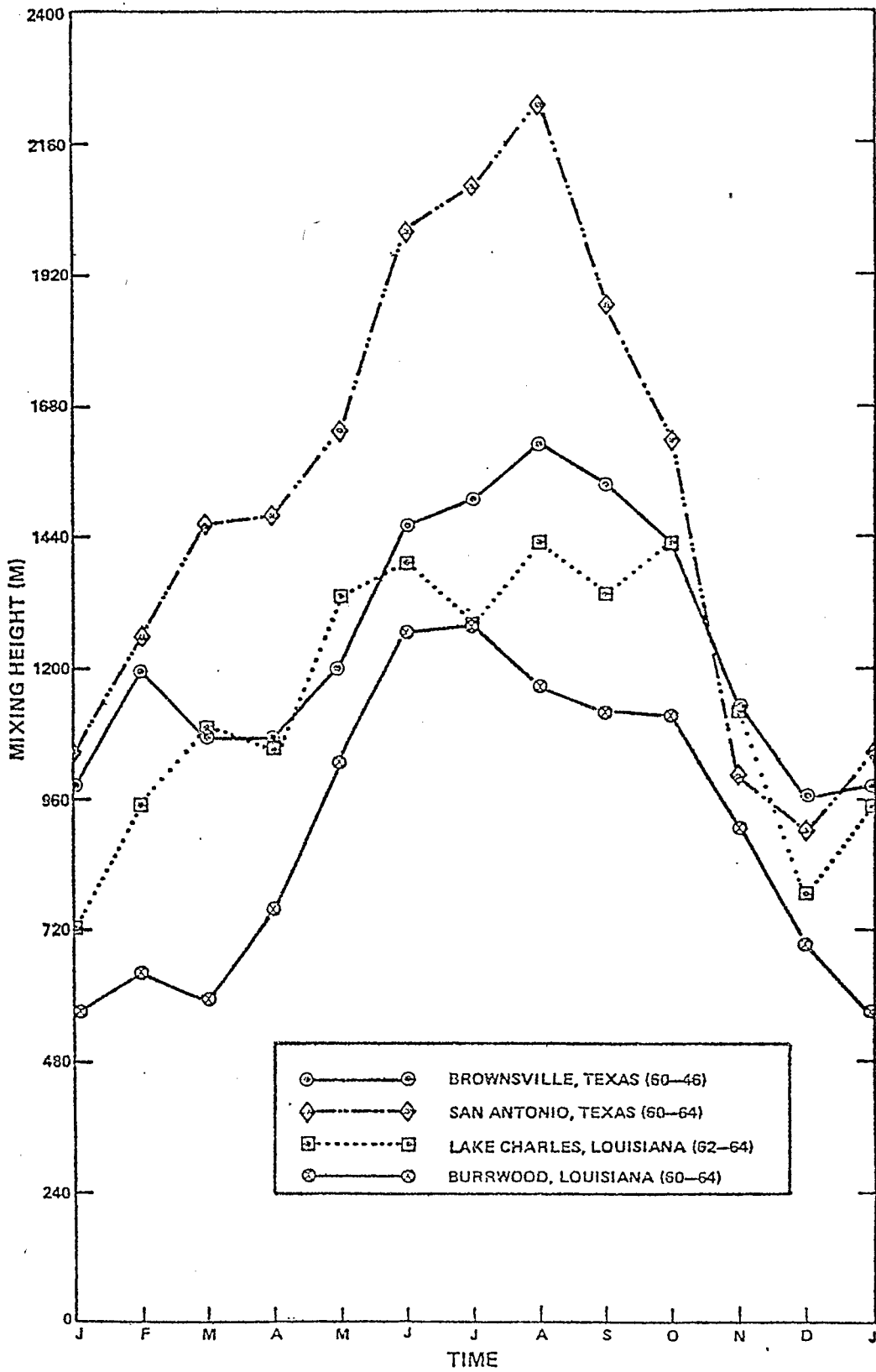

FIGURE B.2-13 MONTHLY AVERAGES OF AFTERNOON MIXING HEIGHT

Table B.2-3

Seasonal and Annual Value of
Morning and Afternoon Mixing Heights (m)
at the SPR Sites

Site	Winter		Spring		Summer		Fall		Annual	
	AM	PM	Am	PM	Am	PM	AM	PM	AM	PM
West Hackberry, Black Bayou, and Vinton	375	850	480	1150	575	1400	390	1300	490	1200
Big Hill	375	875	500	1200	550	1450	400	1300	475	1200

B.2.3.2.3 Wind Fields Within Mixing Layer

Wind speeds increase with elevation above the ground as a function of surface roughness characteristics and atmospheric stability class. Wind direction will also change with height tending toward the geostrophic or frictionless wind. This pattern is observed as the wind veers (clockwise rotation) with height as the effect of surface roughness decreases. Since the SPR sites are located in areas of flat terrain and the SPR sources are low level with little buoyancy, it is reasonable to employ the mean wind speed within the mixing layer for the study of regional transport potential of airborne effluents. Figure B.2-14 and B.2-15 present monthly averages of diurnal wind speed averaged through the mean mixing layer. The data indicate fairly good agreement between wind speeds at San Antonio, Lake Charles and Burrwood with wind speeds at Brownsville being substantially higher. Wind speeds are slightly slower than afternoon speeds. Lake Charles exhibits the lowest average wind speeds during both the morning and afternoon hours.

B.2.3.2.4 Frequency of Limited Dispersion Conditions

Holzworth (1974) has compiled the total number of forecast days of high meteorological potential for air pollution in the contiguous United States. These forecasts are based upon a prediction of a low ventilation factor (product of the mixing height and the mean wind speed through the mixing layer [$H \times U$]) which would result in a regional accumulation of airborne effluent. Figure B.2-16 presents the historical frequency of such "episodes" within the SPR study region for a 5-year period. The figure indicates a frequency ranging from 0 at Big Hill to 5 at West Hackberry, Black Bayou and Vinton sites. The mean position of the high pressure region typically found over the southeastern States is reflected in the pattern of high potential for air pollution and project emissions should tend to have a more significant regional impact at these sites located further east along the coastline.

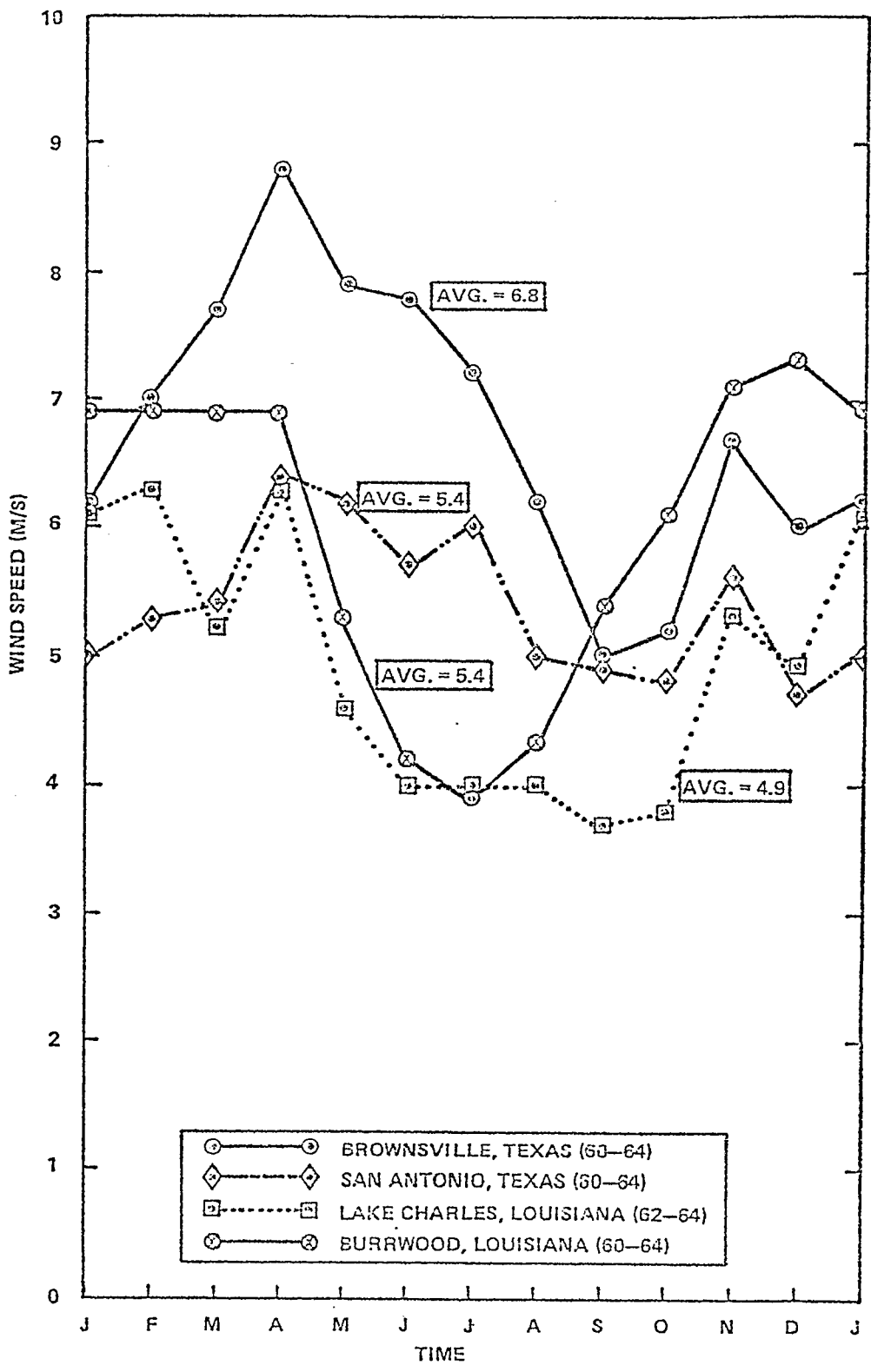

FIGURE B.2-14 MONTHLY AVERAGES OF MORNING WIND SPEEDS WITHIN THE MIXING LAYER*

* WIND SPEED AVERAGED THROUGH THE MIXING DEPTH

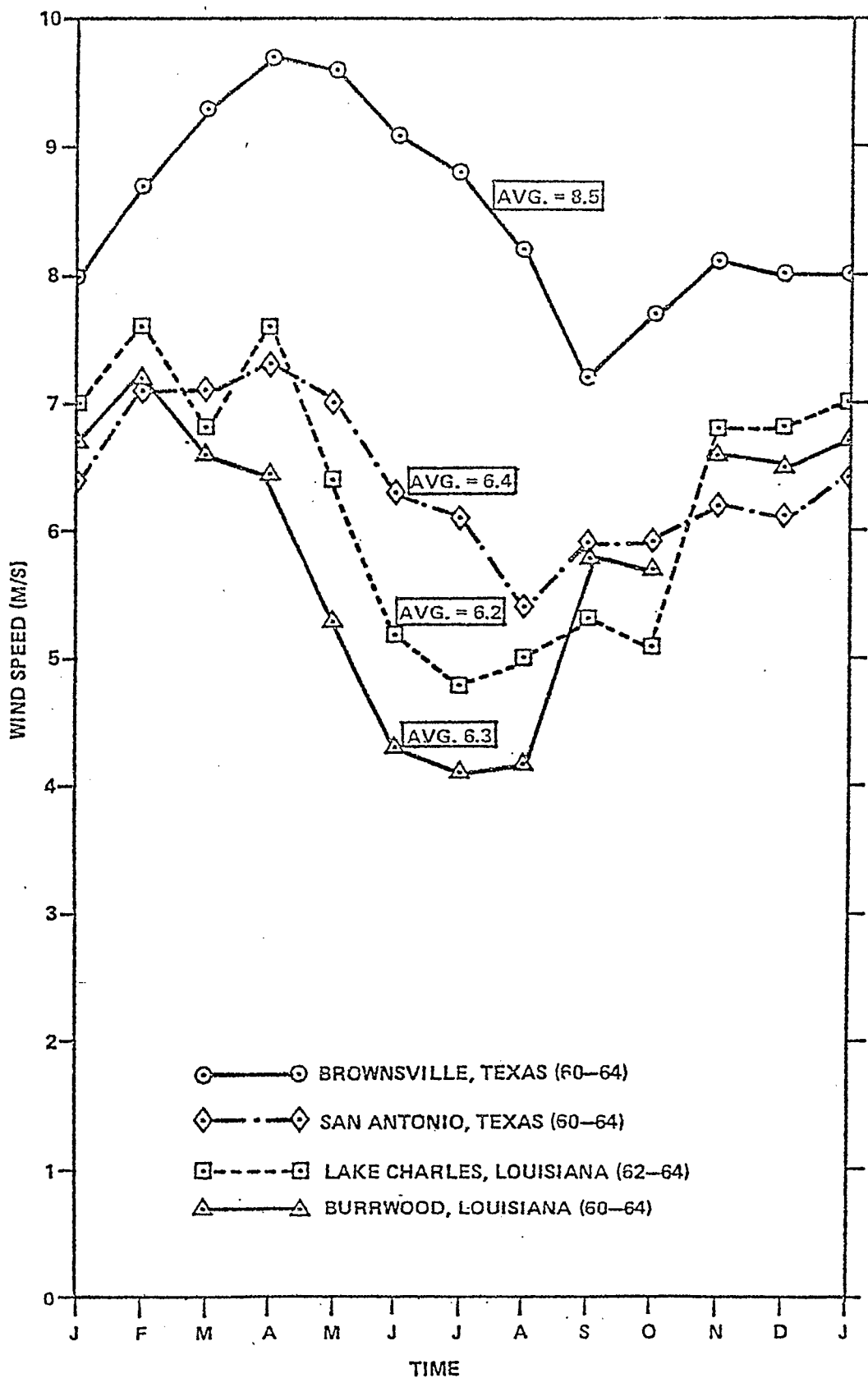

FIGURE B.2-15 MONTHLY AVERAGES OF AFTERNOON WIND SPEEDS WITHIN THE MIXING LAYER*

*WIND SPEED AVERAGED THROUGH THE MIXING DEPTH

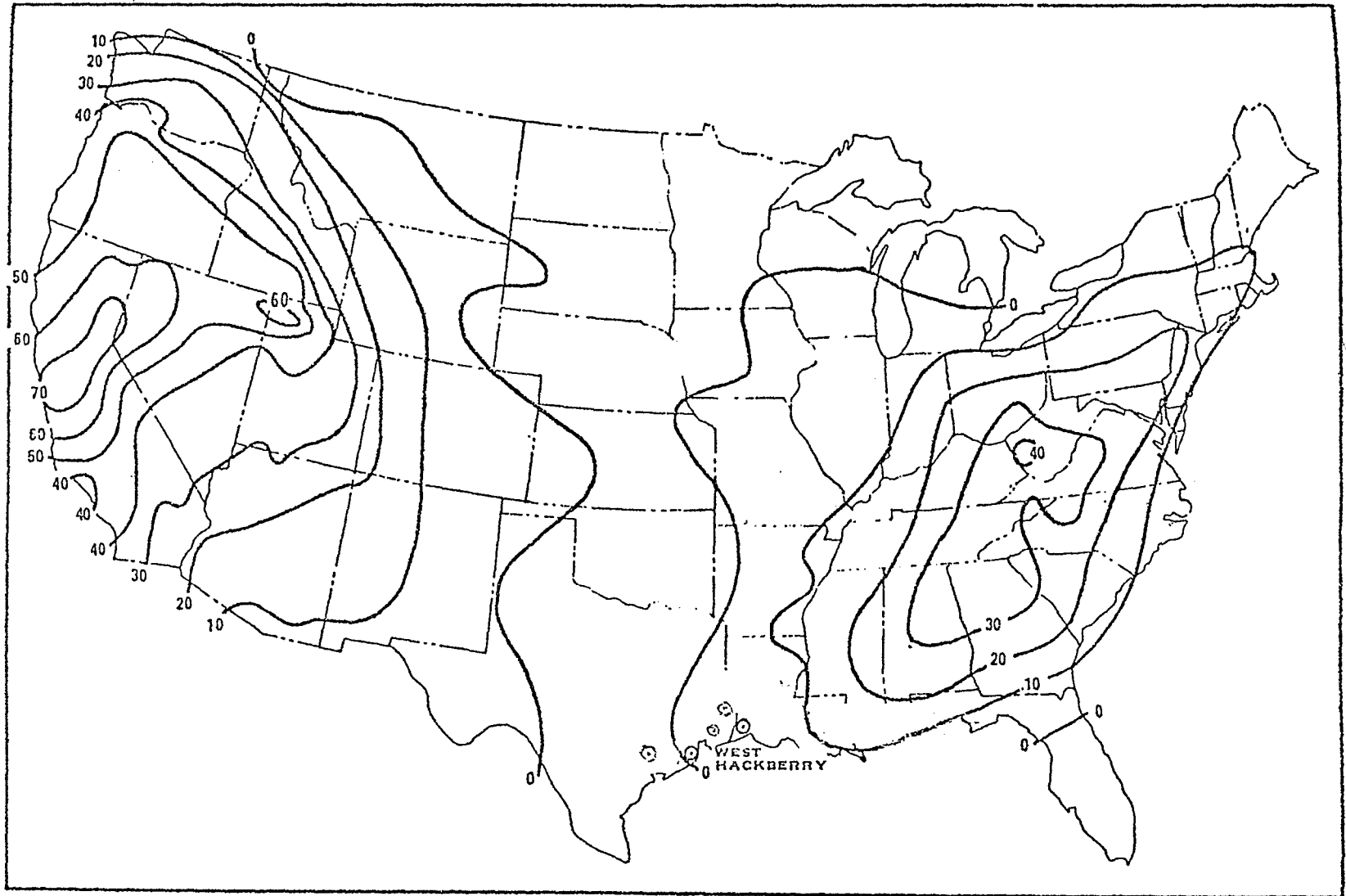

FIGURE B.2-16 ISOPLETHS OF TOTAL NUMBER OF FORECAST-DAYS OF HIGH METEOROLOGICAL POTENTIAL FOR AIR POLLUTION IN A 5-YEAR PERIOD. DATA ARE BASED ON FORECASTS ISSUED SINCE THE PROGRAM BEGAN, 1 AUGUST 1960 AND 1 OCTOBER 1963 FOR EASTERN AND WESTERN PARTS OF THE UNITED STATES, RESPECTIVELY, THROUGH 3 APRIL 1970.

B.2.3.3 Air Quality

This section provides a review of background air quality for the SPR site region. Existing ambient pollutant levels have been established based upon the available sources of representative air quality data. Projected air quality levels are also presented. These projections are based on population and industry growth considerations as well as reasonable proposed controls.

B.2.3.3.1 Existing Air Quality

Figure B.2-17 depicts the sources of data available for the analysis of existing air quality levels. The existing air quality for the SPR site region is summarized in Table B.2-4. As can be seen from this table, the sources of the data are somewhat limited in extent, and emphasis is placed on those stations for which a full year of data is available. The applicable standards are shown in Table C.3-5 in Appendix C. The available data indicate that the National standards for nonmethane hydrocarbon (NMHC) and photochemical oxidants (O_x) were violated at all of the monitoring locations indicated on Figure B.2-17, (NAAQS, 1972). This reveals that levels of these pollutants are regionally high.

Sulfur dioxide (SO_2), nitrogen dioxide (NO_2), carbon monoxide (CO), and hydrogen sulfide (H_2S) concentrations are presently in compliance with all applicable air quality standards, indicating a lack of heavy regional concentrations of combustion processes. The noted violations of the NMHC and O_x standards reflect the extensive development of petrochemical and fuel handling facilities at Gulf Coast ports coupled with favorable conditions for the initiation of photochemical processes. Elevated NMHC readings tend to occur throughout the year, while the photochemical reactions necessary for the generation of higher ground level O_x concentrations occur largely during the summer months.

B.2.3.3.2 Projected Air Quality

Projections of annual second-high oxidant concentrations in the metropolitan areas of Houston-Galveston and Beaumont-Port Arthur, Texas, Lake Charles, New Orleans and Baton Rouge, Louisiana, indicate that the NAAQS will be exceeded beyond the year 1985, assuming the implementation of motor vehicle controls and available control technology (EPA, 1976a, 1976b). Transportation sources and the petroleum industry are the primary oxidant contributors, and levels are projected to increase with population and industry growth through the year 1985. Concentration projections for the Houston-Galveston and Beaumont-Port Arthur areas (EPA, 1976a) are shown in the following table.

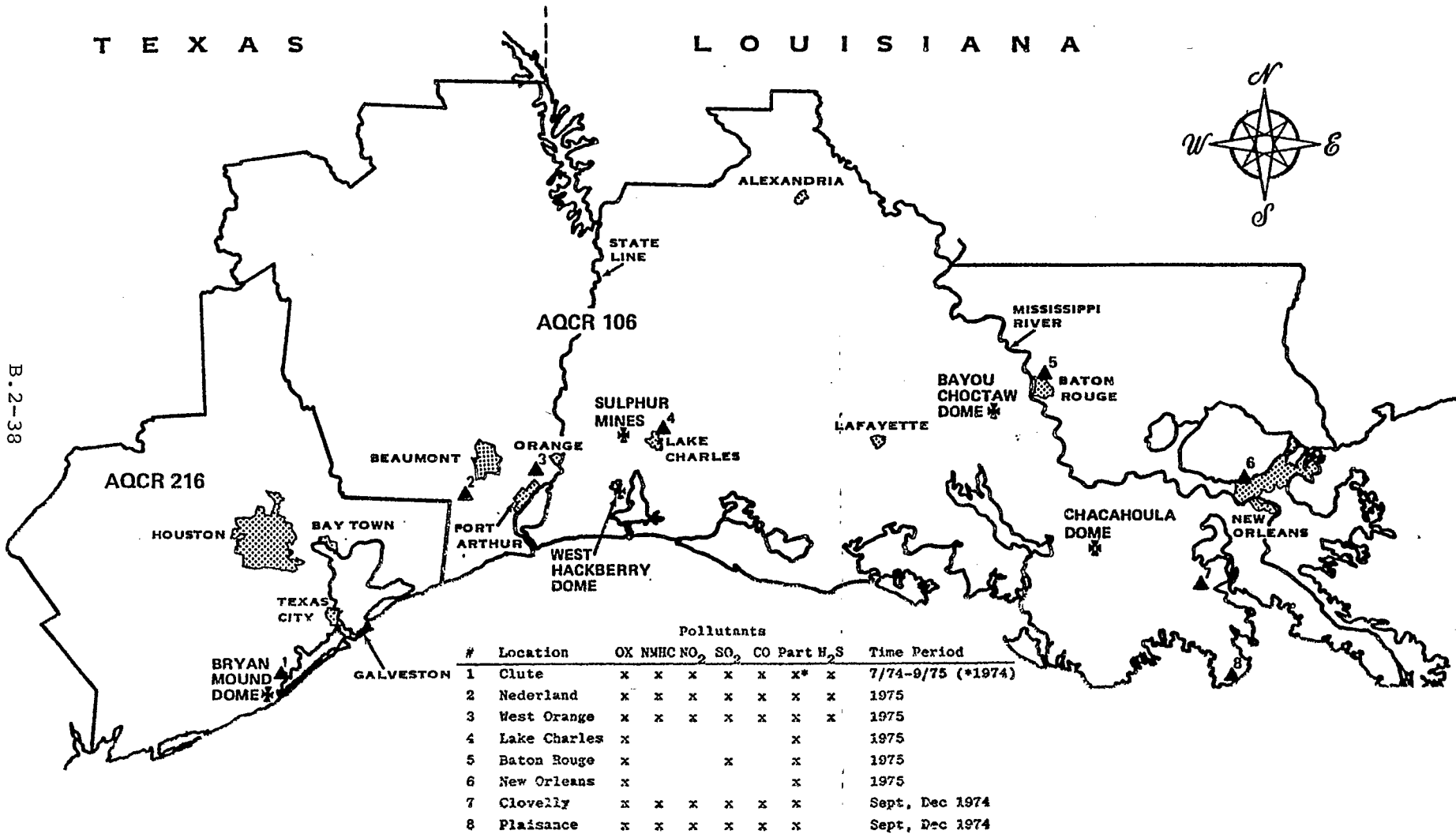

B.2-38

#	Location	Pollutants							Time Period
		OX	NMHC	NO ₂	SO ₂	CO	Part	H ₂ S	
1	Clute	x	x	x	x	x	x*	x	7/74-9/75 (*1974)
2	Nederland	x	x	x	x	x	x	x	1975
3	West Orange	x	x	x	x	x	x	x	1975
4	Lake Charles	x						x	1975
5	Baton Rouge	x			x			x	1975
6	New Orleans	x						x	1975
7	Clovelly	x	x	x	x	x	x	x	Sept, Dec 1974
8	Plaisance	x	x	x	x	x	x	x	Sept, Dec 1974

Figure B.2-17 Location of Ambient Air Quality Monitoring Sites in the SPR Study Region.

TABLE B.2-4

Existing Baseline Air Quality
in the SPR Region*

Monitoring Location	Pollutant	CONCENTRATION ($\mu\text{g}/\text{m}^3$) ¹				Annual ²
		1-hour	3-hour ²	8-hour	24-hour	
Clute, Texas	OX	338				53
	NMHC		2348			533
	NO ₂					20
	SO ₂		27		0	0
	CO	10,171		3,886		457
	Part/H ₂ S ³	/14			154/	89/0
Nederland, Texas	OX	854				56
	NMHC		2,007			400
	NO ₂					20
	SO ₂		240		27	0
	CO	3,543		1,600		229
	Part/H ₂ S ³	/14			129/	56/0
West Orange, Texas	OX	376				54
	NMHC		935			200
	NO ₂					20
	SO ₂		0		0	0
	CO	6,057		4,800		457
	Part/H ₂ S ³	84/43				50/0
New Orleans, LA	OX	182				
	NMHC					
	NO ₂					
	SO ₂					
	CO					
	Particulate				162	72
Baton Rouge, LA	OX	294				
	NMHC					
	NO ₂					
	SO ₂				117	
	CO					
	Particulate				145	56
Clovally, LA	OX	183				
	NMHC		812			
	NO ₂	44				
	SO ₂	51				
	CO	0				
	Particulate				164	
Plaisance, LA	OX	174				
	NMHC		472			
	NO ₂	34				
	SO ₂	20				
	CO	0				
	Particulate				68	
Lake Charles, LA	OX	250				
	NMHC					
	NO ₂					
	SO ₂					
	CO					
	Particulate				154	68

* The location of the monitoring stations, the period of record, and the parameters measured are listed in Figure B.2-17. Shaded boxes indicate violation of standards.

¹ Values given are the second highest for the appropriate time interval with the exception of annual values and the hydrogen sulfide readings.

² The HC 3-hour value is the second highest 6-9 a.m. reading.

³ The arithmetic mean is provided for all the data with the exception of particulate matter for which the geometric mean is presented.

⁴ The Texas H₂S standard is based on a 30-minute averaging period and is not to be exceeded at all.

Projected Oxidant Concentrations* ($\mu\text{g}/\text{m}^3$)

<u>Year</u>	<u>Houston-Galveston</u>	<u>Beaumont-Port Arthur</u>
1973**	---	650
1974**	468	---
1977	300	198
1980	306	198
1985	330	200

* Yearly second-high

**Baseline year

Similar projections for Louisiana are not available; however, the relative constancy of the oxidant concentration projections beyond 1975 in Houston-Galveston and Beaumont-Port Arthur may also be indicative of limits on the level of control believed to be achievable in the Louisiana metropolitan areas.

Nitrogen oxides, sulfur oxides, carbon monoxide, and particulates are not expected to persistently exceed standards in the following 10 years, with the possible exception of sulfur oxides should low sulfur fuels become scarce. Non-methane hydrocarbon levels are projected to exceed the guideline concentration which results in the projections of oxidant levels exceeding standards.

B.2.4 Background Ambient Sound Levels

Background noise levels in and around the region of the SPR sites are typical of a secluded, essentially flat area. In the winter and spring, the contributing noise sources are wind in the trees, periodic bird calls and the rustle of the grasses and brush. The day-night weighted levels are estimated at 48 dBA. (For definition of day-night levels see Appendix F). In the summer, due to the high humidity and warmth, the marshland noise is dominated by the buzz of mosquitoes and other insects, frogs, crickets, and bird calls, and the noise of the foliage on the trees and brush, as winds blow through. On a normal summer evening, the noise levels can be as much as 10 to 15 dBA higher than winter levels because of activities of native creatures and insects.

No ambient noise level measurements were taken at the proposed expansion sites; however, measurement data from communities near Freeport, Texas to the west and Cote Blanche to the east are believed to be representative of background noise levels in and around the SPR region, (see Figure B.2-18).

The measurements taken near Freeport were in the area of Jones Creek (southwest of Freeport) and were performed for the proposed offshore superport, Seadock, Inc. The measurements were

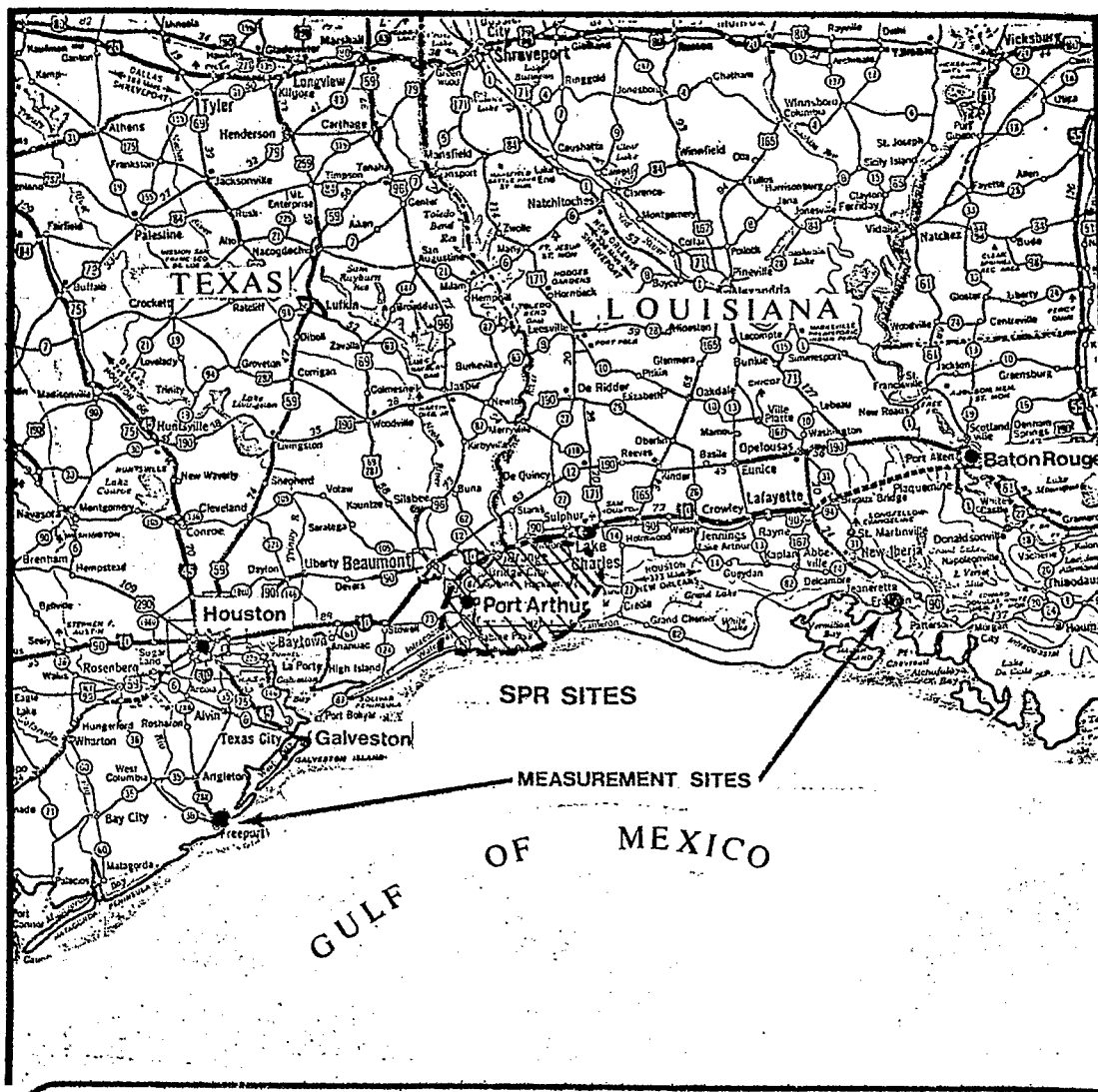

Figure B.2-18 Ambient Noise Level Measurement Sites

taken in early March when insect population is relatively low. Noise levels ranged from 40 dBA during the night to 48 dBA during the day.

The measurement taken near Cote Blanche (See Appendix F), showed levels ranging from 39 dBA at night to 59 dBA during the day for undeveloped areas.

These levels are believed to be typical of noise at the proposed SPR site. Actual noise levels would, of course, vary with the land use and time of measurement.

B.2.5 Species and Ecosystems

B.2.5.1 Introduction

The region in which the storage facilities and their water supply, brine disposal, and oil distribution connections would be situated is ecologically varied, with a large number of habitat types. For purposes of clear reference, this region is defined as the Calcasieu River and the lakes on it in Cameron and Calcasieu Parishes, Louisiana; the areas to the west of these water bodies in the same parishes; Orange and Jefferson Counties in Texas; and the offshore areas in the Gulf of Mexico paralleling the foregoing continental areas. The width of this offshore strip extends slightly beyond the proposed brine diffuser locations, as far as the limit of potential influence from brine release (see Chapter 2.0).

The dominant natural vegetation types in the land area of the region were historically prairie and marshland. Most of the original prairie has been put under cultivation or is used as pasture and range land. The marshland is still largely preserved and some is in federal and state refuge systems. Forests are found along some water courses inland from the coastal swath of marshes and in the northernmost, most inland parts of the region. Deep channels dredged in the main rivers, the Calcasieu, the Sabine, and the Neches, have resulted in salinity intrusion many miles inland along these rivers and connected water courses. Canals extend into the marsh and elsewhere which in many cases cut across the natural hydrologic drainage direction. The ICW at the north end of the marshes has particularly altered the former drainage. Large reservoirs are present in and adjacent to the marshes in some locations within the region. New habitats have been created and former ones reduced and modified by spoil disposal, levee construction, and sedimentation. Oil and gas production is prevalent. Many areas have been filled or drained. Many, if not most, of the marshland and water bodies have a species composition which is much different from what it would be in the absence of large-scale, human-sourced environment modifications.

Western Cameron Parish

The western part of Cameron Parish, Louisiana, in the southeastern part of the region, is mainly comprised of marshland, part of Sabine Lake and Calcasieu Lake, and some smaller areas of former prairie. Agricultural and urban/industrial uses are quite restricted and forests are not present. Calcasieu Lake, connected waterways and water bodies, and the offshore area in the Gulf of Mexico function as highly productive fisheries. Both commercial and sport harvesting are quite important here. Sabine Lake is no longer very commercially productive. Commercial harvesting of furbearing mammals is at a high level in the parish. Such harvesting is permitted within the extensive Sabine National Wildlife Refuge. This refuge is one of the main overwintering areas for waterfowl using the Mississippi flyway and also receives birds from the Central flyway.

Western Calcasieu Parish

The western part of Calcasieu Parish, Louisiana, in the northeastern part of the Texoma region, is mainly prairie which has been put to agricultural use. This prairie expanse was essentially a grassland with trees prevalent only along flood plains on the marginal slopes of streams. Swamp forest and bottomland hardwood communities are present in the extreme western portion along the Sabine River and north of Lake Charles (the northernmost lake in a chain of lakes on the Calcasieu River north of Calcasieu Lake) along the Calcasieu River flood plain. In between these strips of forest along the Calcasieu and Sabine rivers in the northern part of the parish are mainly flatwoods and, along and near the included water courses, a different association of bottomland hardwoods. Most of this area has been greatly altered by lumbering. Commercially-managed timber stands are present in some locations while much of the rest of the area has stumps and low brush and frequently is used for cattle forage land. Swamp forests along the Sabine and Calcasieu Rivers have been little disturbed. Fingers of intermediate, brackish, and fresh marsh project into the southern part of western Calcasieu Parish, creating a complex wetlands environment. Occasionally salinity intrusion occurs in this area above the level of Sabine Lake on the Sabine River system and above the level of Lake Charles in the Calcasieu River system. A salt-water barrier has been constructed above the level of Lake Charles to reduce such intrusion.

Urban or industrial areas in western Calcasieu Parish include Westlake, Maplewood, the Hollywood industrial park, Sulphur, and Vinton. These are arrayed along Interstate 10, which extends to Orange, Texas, from the city of Lake Charles, Louisiana. All but Vinton may be considered part of the Lake Charles greater metropolitan vicinity.

Orange County

Orange County, Texas, to the west of Calcasieu Parish, Louisiana, contains urban areas, forest, prairie, marsh areas, bayous, lakes, and creeks. It is bounded by the Neches River on the south and west and Sabine Lake and River on the east. The two largest cities, Orange and Bridge City, lie in the southeastern part of the county. Coastal prairie is extensively represented in the county. This has a relatively flat character. Along with wooded and marsh-covered stream courses such as Cow Bayou, forested belts trending from the northwest into the Orange vicinity and to the west of Orange subdivide the coastal prairie between the Neches and Sabine Valleys into numerous small, commonly isolated prairies. Marshes are present in a discontinuous band along the margin of Sabine Lake and cover most of the lower 15 miles of the Neches Valley. These marshes range from brackish to fresh with a general decreasing salinity gradient away from the channels in the lake and river. Extensive swamps extend up the Neches Valley for about another 15 miles beyond the marsh areas. Marsh is also common on the Sabine River for approximately 7 miles. Above this it is largely supplanted by swamp, which is prevalent for several miles up-stream and more restricted further along. Smaller areas of marsh and swamp are present along smaller water courses extending westward from the Sabine River such as Cow Bayou. Sabine Lake is shallow (less than nine feet deep). The ICW is dredged through Sabine Lake and a portion of the Sabine River on Orange County's eastern edge.

The areas which were historically natural prairie are now mostly cultivated in crops. Ranching is common on higher marshland, fallow croplands, and within wooded river valleys. Orange is an industrial center. Oil and gas fields are present, but are not concentrated in one general location. Sabine Lake is not very productive of seafood, although it was in the past.

Jefferson County

Jefferson County lies to the southwest of Orange County on the Gulf Coast and contains much of the western part of Sabine Lake. The acreage of the county which was originally prairie grassland (more than 60 percent) is now mainly utilized in crop production and as pasture land. This prairie grassland-farmland is primarily located in the northern upland part of the county. The greater portion of the remaining land consists of saline to fresh marshes. The marshes border the Gulf of Mexico, Sabine Lake, the Neches River, and other waterways connected to the coast. Further inland along the bayous are stretches of swamp-forest. The low-lying marsh areas with elevations generally less

than 5 feet above sea level are commonly flooded by hurricane tides or storm tides and runoff. They primarily support salt resistant grasses and their associated fauna. Areas of pine and hardwood forest are located in the northern part of the county and other forests are present in the west-central part (Lawhorn Woods) and along branches of Taylor Bayou to the east. Many reservoirs have been constructed on the landward side of the coastal marsh system, including in the J. D. Murfee State Wildlife Management area southwest of Port Arthur and west of Sabine Lake. Natural lakes and ponds are present in the coastal marshes to the southwest of Port Arthur also.

Port Arthur, Beaumont, Port Acres, Port Nederland, and Nederland are clustered in the northeastern part of the county near the Neches River and Sabine Lake. This is the main area of industrial and residential-urban development. The ICW passes through the coastal marshes from Port Arthur, passing through Jefferson and Chambers Counties to link it to East Galveston Bay. Most land constructed in marshes in the Port Arthur area has been developed into industrial and residential tracts. Dredge spoil is prevalent along the ICW, parts of the Sabine and Neches Rivers, and some waterways connected to the latter.

Rice is the major crop in Jefferson County, Calcasieu Parish and the prairie sections of Orange County. A complex irrigation and drainage network is employed in this rice production which greatly alters the land. Although the fisheries productivity of Sabine Lake has greatly declined, the offshore Gulf areas in Jefferson County remain highly productive for commercial fishermen and attractive for sport fishing. Development of oil and gas fields is well dispersed throughout Jefferson County.

Marsh Characteristics and Value

While the value of agricultural and forest areas is apparent to most people, the same may not be true of marshes. A very good case may be made for their importance.

On the average, salt marshes produce a net quantity of 8.9 tons of dry organic material per acre per year. Only tropical rain forests, coral reefs, and some algal beds produce more abundantly. The best farmlands are only half as productive. This high level of productivity supports extensive food chains within the marsh and in adjacent bay systems. Because of the high productivity of marsh plants, a tidal marsh can assimilate high levels of municipal and industrial wastes and incorporate them

into its yield of organic material. Tidal marshes serve as nursery areas for various estuarine species. A variety of furbearing animals, game fish, and waterfowl--including several "endangered species"--rely upon the tidal marsh for habitat. Tidal marshes also aid in erosion control by absorbing wave energy and serve as temporary floodwater buffers.

Human uses supported by the marsh system include:

- waterfowl management and hunting
- livestock grazing
- commercial and sport fishing
- waterborne transportation
- recreation and aesthetic enjoyment
- mineral production
- agriculture
- waterfront land development for resorts, and second homes.

It is unlikely that a marsh system could sustain all of these uses at any one time in one location, since a few uses listed may preclude some or all of the others. However, marsh systems typically provide many values simultaneously.

B.2.5.2 Ecosystems

B.2.5.2.1 Characteristics of Ecosystems in Western Cameron Parish

The most extensive area in western Cameron Parish is part of the coastal Chenier Plain. This consisted, in its primitive state, of marshlands containing natural ridges extending in a general east-west direction. These ridges or cheniers are stranded former beach lines which play a large role in directing water flow through the marshes. The cheniers typically support grasses and frequently trees, especially oaks. The development of oaks and other trees varies from just a few scrub specimens to dense stands. Man-made levees and spoil have changed the topographic features in many parts of the marshes. In many areas lakes, bayous, and canals are concentrated so that the marsh may not seem to be a land mass at all but rather a large region of small islands. At the other extreme, marsh vegetation also grows in unbroken stands which can cover large reaches.

Chabreck (1970), who based his classification of marsh vegetation types on one reported by Penfound and Hathaway (1938) subdivided the Louisiana coastal marshes into four vegetation types, based primarily on the salinity of the surface water. The four marsh types and their average salinities and ranges of salinities (Chabreck, 1970), are as follows:

<u>Marsh Type</u>	<u>Salinity Range (ppt)</u>	<u>Avg. Water Salinity (ppt)</u>
Fresh	0 - 4.0	1.5
Intermediate Marsh	2.0 - 6.0	3.3
Brackish Marsh	3.0 - 18.0	8.1
Saline Marsh	6.0 - 29.0	15.9

The soil and water chemical characteristics according to Chabreck (1972) for the four different marsh vegetation types in Hydrologic Unit IX, which includes the marsh areas in Cameron Parish, are shown in Appendix K.1, Table K.1-1. Marshes closest to the coast generally have the highest salinities, with the salinity levels decreasing as one proceeds inland. However, exceptions to this rule are fairly numerous, especially along drainage systems. Marsh soil is noteworthy for its high content of organic matter.

The saline marshes have higher standing crop and lower species diversity in comparison with the other types. Chabreck (1970) lists 93 species for the freshwater marsh, making it the most diverse. The species compositions for the marsh types are shown in Appendix K.1, Table K.1-2.

In Hydrologic Unit IX, saline marshes are dominated by Batis maritima, maritime saltwort, (20% of the plants present), Distichlis spicata, salt grass, (55%), and Spartina alterniflora, smooth cordgrass, (24%). Brackish marshes are dominated by Spartina patens, salt marsh cordgrass (60%), with Bacopa monnieri, Monnier's hedge hyssop, Distichlis spicata, Paspalum vaginatum, and Scirpus olneyi, Olney bulrush, each comprising between 5 and 10 percent of the total number of plants. Intermediate marshes are also dominated by Spartina patens (47%) with Paspalum vaginatum (13%) next in importance, and a number of other species, Phragmites communis (common reed), Sagittaria falcata (bull tongue), Scirpus californicus (giant bulrush), and Scirpus olneyi, all contributing between 4 and 7% of the

number of plants present. Intermediate marshes usually occur as narrow bands between brackish and fresh marshes. Due to salinity changes in the southwestern Louisiana area (salt intrusion) related to man's activities (channel modifications and ground water consumption) the intermediate marshes are shifting inland.

The fresh marshes have Alternanthera philoxeroides, alligatorweed (26%) and Sagittaria falcata (23%) as co-dominants with secondary species (5-10%) including: Eleocharis sp., spikerush, Paspalum vaginatum, Scirpus californicus, and Spartina patens.

Inorganic nutrients are introduced into the marsh systems via fresh water and tidal inflows. Much of this nutrient influx is trapped on and in the sediments where it becomes available to the marsh vegetation. Nutrients are incorporated into plant material which is eventually decayed and recycled by abundant micro-organisms. A relatively rapid dynamics, incorporation of inorganic nutrients in plant substances, and reincorporation of the decomposition stages into sediments where it is available for subsequent use by plants and animals is characteristic of marshes.

Some amount of salt water is necessary to maintain most tidal marshes. The amount determines the general type of marsh and assemblage of plants and animals present. Higher levels of salinity reduce productivity and the rate at which sediments take nutrients from the water.

Large amounts of organic material are produced in marshes that are used both in the marsh and adjacent estuarine systems. As much as half of the organic material produced in marshes may be carried to adjacent estuaries where it is very important in food chains. Within the marsh itself, detritus, associated micro-organisms, protective habitat, and other conditions make for prime nursery areas for a variety of economically important and other animal species.

Calcasieu Lake is the dominating open-water estuarine area influenced by the marshes in western Cameron Parish. Sabine Lake is next in importance. Collections made in the estuarine areas of southwestern Louisiana from April 1968, through March 1969, indicate that the most common vertebrate species are menhaden (Brevoortia patronus), bay anchovy (Anchoa mitchilli), and Atlantic croaker (Micropogon undulatus). The most common invertebrates taken were blue crabs (Callinectes sapidus) and

white shrimp (Penaeus setiferus). Trawl samples which were also taken as part of the study showed that spot (Leiostomus xanthurus), Atlantic threadfin (Polydactylus octonemus), and brown shrimp (Penaeus aztecus) were also common. Complete listings of the species collected are presented in Appendix K.2, Table K.2-1.

The dominant fish species present in the marsh proper are Gulf killifish, (Fundulus grandis), longnose killifish (F similis), variegated cyprinodon (Cyprinodon variegatus), common mosquitofish (Gambusia affinis), and sailfin molly (Mollienesia letipinna). Most species present in open waters of the estuary are present in the marsh or channels in the marsh also.

Benthic, epiphytic, and periphytic algae characteristic of coastal Louisiana are presented in Appendix K Table K.3-1. These categories are discussed below. The soft mud, silt, and sand bottoms present throughout most of the offshore coastal area do not generally favor benthic (bottom) algae. Most of the algal information presented here are from a U. S. Corps of Engineers Report literature review pertaining to dredging in the ICW (U. S. Army Corps of Engineers, 1975).

Benthic algae are often found on the banks of streams, lakes, and quiet pools in the marshes. In brackish waters, the most common genera are Enteromorpha, and Ectocarpus, large filamentous green and brown algae found primarily during the winter months from early November to mid-April and early May with their peak production occurring in January.

A number of other filamentous algae have been found in the above situations, mudflats, rocks, and submerged pilings. Species of Ulvella, Ulothrix, Cladophora, Spirogyra, Rhizoclonium, all green algae, are often located away from the main tidal streams in small channels and ponds where water movement is restricted. However, Vaucheria is often found on the banks of small tidal streams. Some algal species grow attached to the bottom at various depths, although high turbidities are often limiting. Blue-green algae (Lyngbya) and green algae (Cladophoropsis and Rhizoclonium) are found at depths of 5 to 10 feet in some of the clearer waters.

Blue-green algae often grow on mudflats and the edges of water bodies and form algal mats among rooted vegetation. Principal genera are Oscillatoria, Lyngbya, and Spirulina. Less important genera are Chroococcus, Merismopedia, and Microcystis.

Benthic diatoms have not been extensively studied. However, some more common genera include Amphora, Denticula, and Diploneis.

Epiphytic and periphytic algae are those species which grow on other plant species such as the higher vascular plants growing in the marshes and along streams and channels. The major growth forms are single-celled algae or algae with little cellular differentiation and organization and larger more complex species with a multicellular, usually cylindrically arranged organization. The major components of the less complex group are diatoms, with the major genera being Amphora, Melosira, Cocconeis, Denticula, and Nitzschia. Spatial differences in the distribution of diatom genera occur, with Nitzschia dominating inland vegetation in the saline marsh, while Amphora, Melosira, and Cocconeis occurs principally on vegetation near the edges of saline marshes. Seasonal peaks in populations take place during the year. Cocconeis has a peak production during early summer and again during the fall and Amphora has a peak in late spring. These relatively simple, encrusting algae form parts of varyingly conspicuous periphyton layers.

The more complex species include the genera Enteromorpha, Ectocarpus, Bostrychia, Polysiphonia, and Gracilaria. These epiphytes are found in brackish to saline waters; however, Enteromorpha is also found in freshwater habitats.

Blue-green algae may occur as major growths in freshwater habitats in inland, fresh, and brackish marsh regions. Major genera found from these groups are Oscillatoria, Lyngbya, and Spirulina.

Day, et al., cited by the U. S. Army Corps of Engineers (1975), found that there were seasonal changes in dominant epiphytic algae. When water levels and temperature are high in the summer, Bostrychia and Polysiphonia are dominant; however, when water temperatures and levels drop during the winter, Enteromorpha and Ectocarpus dominate.

Shellfish are of considerable economic importance to southern Louisiana. The large zone of brackish water and marsh with salinity above approximately 5 ppt is extremely productive for oysters, shrimp, and crabs. The Eastern or Atlantic oyster, Crassostrea virginica, is the only species of oyster with commercial value in Louisiana (Pollard, 1973). It inhabits estuaries with virtually all degrees of salinity levels, but permanent communities flourish between 10 and 30 ppt.

The brackish water clam, Rangia cuneata, forms the great bulk of shell accumulations in Louisiana deposits (Pollard, 1973). Other less abundant genera found in the brackish marshes of the area include Littoridina, Mulinia, Tellina, Vioscalba, and Tagelus (Tarver and Dugas, 1973).

One species of crab, the blue crab (Callinectes sapidus), is of significant economic importance in the area. Blue crabs spawn in the Gulf of Mexico and lower bays near tidal inlets and large waves of larvae enter the estuaries from January through March. Among other common genera of crabs found in Louisiana estuaries and tidal areas are the hermit crab (Eupagurus spp.), ghost crab (Ocypode spp.), fiddler crab (Uca spp.) and Callinectes donae a smaller relative of the blue crab. The horseshoe crab (Limulus polyphemus), which is not actually a true crab, is also common in these areas.

In the brackish marsh areas other organisms commonly found are nematodes, copepods, ostracods, and rotifers. Nematodes represented 61 percent of a total sample (Dames and Moore, 1975). Minor components of the samples were large protozoans, Foraminifera, and cumaceans. Brackish marshes seem to have the lowest diversity of mollusks, with greater diversity occurring in both saline and fresh areas (Thomas, 1975).

As marshes become more saline, the benthic invertebrate population may become dominated by nematodes, harpacticoid copepods, amphipods, ostracods, chironomid larvae, and polychaetes. Tanidaceans and cumaceans are occasionally numerous (Dames and Moore, 1975). Marsh periwinkle (Littorina irrorata) is a common mollusk in the salt marsh region. Other mollusks include the oyster drill (Thais haemostoma), the Atlantic moon snail (Polinices duplicatus), and the Atlantic ribbed mussel (Molliolus demissus).

Diplolaimelloides brucei is the only nematode specifically identified from Louisiana marshes (U. S. Army Corps of Engineers, 1975). The majority of benthic copepods are harpacticoids, but several species are ones commonly found in the plankton. Among the more common harpacticoids are Canuella, Nitocra, Paralaophonte and Tachidius (U. S. Army Corps of Engineers, 1975). Copepods consume detritus and phytoplankton. Amphipods are often the most common organisms after nematodes and copepods. The two most common species of amphipods are Corophium lacustre and Ampilesca sp. (U. S. Army Corps of Engineers, 1975). Corophium is often associated with submerged aquatic plant roots such as

salt marsh cordgrass, while Ampileasca is most common in submerged sediments adjacent to shores. Polychaete worms often occur in the sediments (U. S. Army Corps of Engineers, 1975). They feed on detritus, algae, and small crustaceans such as copepods and amphipods. Neanthes succinea is the most common polychaete in Louisiana coastal marshes.

Arthropods collected from saline marshes include the mantis shrimp (Squilla sp.), Cymadusa compta, Grandidierela sp., Cerapus tabularus, Gammarus mucronatus, and Hyaella azteca (Dames and Moore, 1975). Salt marsh decapods include the stone crab (Menippe mercenaria) and a mud crab (Panopeus herbstii) (Thomas, 1975).

In the fresh and slightly brackish waters in the inland part of the marshes, the benthic fauna is dominated by Diptera, oligochaetes and amphipods (U. S. Army Corps of Engineers, 1975). The Diptera consist primarily of the chironomid genera Procladius, Cryptochironomus, Coelotanypus, and Polypedilum. The chironomids are commonly referred to as bloodworms because pigments in their respiratory mechanism allow them to live in waters with low dissolved oxygen levels. They are often used as indicators of stress on the aquatic environment. Other Diptera include the phantom midge and Bezzia. The oligochaetes are represented by the tubificids which are also known as the sludgeworms. Commonly observed genera include Limnodrilus and Peloscolex which are often dominant in substrates with thick organic sediments and low oxygen levels. Corophium is the dominant genus of amphipod that occurs in these waters. Other amphipod genera commonly found include Acanthohaustorius, Monoculodes, Orchestia, Hyaella, and Gammarus.

Other invertebrates inhabiting fresh and slightly brackish sediments include isopods (Cyathura, Edothea) trichopteran larvae (Hydropsyche), leeches, mollusks, barnacles, protozoans, and nematodes. The leeches are free-living scavengers and parasites. Placobdella often attaches to reptiles. Macrobdella is parasitic on vertebrates as is Piscicola on fish. Mollusks are represented primarily by Littorina and Corbicula.

The benthic invertebrates exist on or in the substrate. They feed on detritus, phytoplankton, and bacterial material and are preyed upon by larger invertebrates (crabs, shrimps) and fish species. Many are relatively immobile organisms. Therefore, their presence or absence in a particular area may provide an indication of the long-term environmental conditions present in an area.

The number and variety of benthic invertebrates is highest at the land-water interface at the edge of marshes (U. S. Army Corps of Engineers, 1975). Sediments in the middle of the marsh vegetation are not as influenced by tidal flushing and nutrient movement, whereas the sediments near the shore are highly organic and composed of larger particles as a result of the accumulation of detrital material washed in from the surrounding marsh. Sediments in the middle of water bodies are not as productive as near the shore.

The majority of phytoplankton found in the standing waters of the marshes, ponds, and lakes consists of green algae, blue-green algae, and diatoms. Among the common algae reported in salinities from 0.0 to 7.2 ppt for four algal groups are the following: green algae (Scenedesmus brasiliensis, Pediastrum spp., Staurostrum spp.), blue-green algae (Anabaena spp., Oscillatoria spp., Spirulina sp., Microcystis sp.), diatoms (Coscinodiscus spp., Melosira spp., Pleurosigma sp.) and flagellates (Trachelomonas spp., Synura spp., Pandorina sp., Eudorina sp., Chlamydomonas spp., Euglena sp.) (U. S. Army Corps of Engineers, 1975). Another assemblage of species has been noted for salinities of 5 to 20 ppt in the coastal waters influenced by the Mississippi. The main species in this assemblage included Cyclotella compta, C. meneghiniana, Melosira distoms, M. granulata, Navicula gracites, N. rhynccephala, and Nitzschia clostercium.

Diatoms are the most abundant type of phytoplankton in the marsh areas of Louisiana where saline to brackish conditions exist (U. S. Army Corps of Engineers, 1975). Dinoflagellates are the second most common phytoplankton group in saline and brackish waters. Representative dinoflagellate genera are Ceratium, Glenodinium, and Phyrocystis. Green and blue-green algae are minor constituents of the phytoplankton communities.

The zooplankton of the southwestern Louisiana coastal zone were surveyed from April 1, 1968, through March 31, 1969. Results of the survey are presented in Appendix K.4, Table K.4-1. The most numerous zooplankton reported was Acartia tonsa. Other commonly encountered zooplankton were coelenterates, ctenophores, decapod larvae, and other copepods. Many of the zooplankton taken from Calcasieu Lake are eurythermal and euryhaline. This means these organisms have broad thermal and salinity tolerances.

Salinity appears to be the chief controlling factor in the number of species present, while temperature, ecological competition, and predation also control the number of species present (Gillespie, 1971). Zooplankton biomass appears to be highest in April and September and lowest in mid-summer and mid-winter.

Larval decapods of importance include the netclinger (Acetus americanus), mud crab (Rhithropanopeus harrisi), and Leander tenuicornis. Other groups present include polychaete larvae, arrow worms, tunicates, and rotifers.

Zooplankton levels in Calcasieu Lake deriving from inward movement of Gulf water must be judged low based on sampling at Calcasieu Pass and nearby areas such as Sabine Pass and the mouth of the Mermentau River. These areas are deficient as compared to other Louisiana coastal areas that were sampled (Gillespie, 1971).

There is evidence for higher local zooplankton production in Calcasieu Lake. A rotifer survey of the general area in 1966-67 revealed maximum quantities of main species of over 2,000 individuals per liter. More recently, Dr. Stickele of the Louisiana State University Zoology Department, who has been directing a survey in the estuary, has recorded a relatively high number of copepods, fish, and benthic invertebrates (total well over 100 species; copepods approximately 30 species) (Stickele, 1976). The zooplankton community in Louisiana coastal marshes of all salinity is estimated to average 25 grams of organic material/m²/yr.

The Gulf offshore area adjacent to southwestern Louisiana extends over the continental shelf to a distance of more than 100 miles (Stone and Robbins, 1973). It is important to commercially important fish and invertebrates such as menhaden, Atlantic croaker, mullet, and brown and white shrimp, especially during winter spawning. Other species are given in Appendix B.5, Table B.5-1. Wide ranging fish such as ocean sunfish, oarfish, and king mackerel and sea mammals such as seals and whales are also present. Demersal fish are abundant in different areas on a seasonal basis.

Little benthic vegetation is present. Food webs are based largely on phytoplankton. Major species reported from higher salinities offshore in the Gulf in the general region of the Mississippi River discharge included: Nitzschia seriata, Thalassiothrix frauenfeldii, Thalassionema nitzschioides, Skeletonema costatum, Asterionella japonica, Chaetoceros affinis and C. diversus. Many burrowing filter feeding animals are found on the bottom. Such animals as phoronids, pelecypods, and polychaetes are typical.

There is a characteristic association of sedimentary invertebrates in the white shrimp (Penaeus setiferus) grounds on muddy bottoms (Hedgpeth, 1954). These extend to a 10 to 15 fathom depth offshore. Included are the sea pansy, Renilla muleri; Leptogorgia setacea, a gorgonian; tube building worms of the family Onuphidae; crabs of the genera Hepatus, Calappa, and Persephone; the anemone, Paranthus rapiformis; and gastropods such as Busycon, Murex, Dolium, and Fasciolaria. The red hermit crab inhabits the shells of these snails commensally with the porcellan crab, Porcellana sayana. The sea pansy seems to literally cover the bottom in some locations. In addition to the species cited above, the stomatopod, Squilla empusa, is common, but it tends to occur in irregular colonies. Bottom communities in brown shrimp (Penaeus aztecus) areas differ especially in that Renilla is no longer prominent; the Starfish Astropecten is abundant, and the bivalves, Pitaria cordata and Chione clenchi, are much more abundant farther offshore than in white shrimp areas.

The sand beach zone has a rich floral and faunal community adapted to periodic exposure to the atmosphere (Stone and Robbins, 1973). Organisms are present in the interstitial spaces between sand grains. Many mollusks, annelids, and crustaceans that burrow are present in this zone and it is critical to such fish as juvenile pompano, gulf kingfish, banded drum, longnose killifish, and rough silversides. Amphipods (e.g., Orchestia grillus, O. platensis, and Talorchestia longicornia) are associated with windrows of algae (Sargassum in spring and various reds in winter) (Hedgpeth, 1954). The ghost crab, Ocypode albicans makes burrows above the high tide lines. Bottom organisms include Dinax which occurs in large beds and moves up and down with the tides. Offshore there are large populations of such bivalves as Dinocardium robustum, Arca and Anadara; predaceous gastropods such as Dosinia and Tellina; and echinoderms such as Mellita and Astropecten.

Extensive drained areas are present near the coast in western Calcasieu Parish. One section is near Ocean View Beach toward Sabine Lake and there is a smaller area bounded by the coast on the south and the Calcasieu Ship Channel on the east. These areas are used for cattle grazing.

Today the prairie areas are mainly agricultural areas and improved pastureland. Natural prairie vegetation is predominantly switch grass (Panicum virgatum), big bluestem (Andropogon spp.), Indian grass (Sorghastrum avenaceum), and prairie wildgrass (Sphenopholis obtusata). Typical pasture species

are signal grass (Brachiaria platyphylla) and goatweed (Croton capitatus). Trees are found in scattered areas and around residences. These trees are a mixture of oaks, ash, American elm, and sweetgum. Fingers of prairie project down into the eastern part of western Cameron Parish along Calcasieu Lake and into the central and western parts as well.

Discussion of land vertebrates (birds, mammals, amphibians and reptiles is deferred to Section B.2.5.2, Terrestrial Vertebrates of the Texoma Region). Waterfowl and aquatic and semi-aquatic mammals, reptiles, and amphibians are covered by this discussion. Other sections deal with commercially important plants (B.2.5.3.1) and animals (B.2.5.3.2) and recreationally important animals (B.2.5.5).

B.2.5.2.2 Characteristics of Ecosystems in Western Calcasieu Parish

The larger part of the vegetation of western Calcasieu Parish is composed of species present in croplands and pasture tracts derived from coastal prairie. Rice and soybeans are the main crops although some other crops also are cultivated.

Pasture grasses generally include signal grass and goatweed. Where natural prairie grasses remain, switch grass (Panicum virgatum), big bluestem (Andropogon spp.), Indian grass (Sorghastrum avenaceum), and prairie wildgrass (Sphenopholis obtusata) are characteristically prevalent. Many dabbling ducks and geese feed in the prairie and rice fields. The Fulvous Tree Duck, a long-legged goose-like bird, commonly breeds in rice fields. Birds, mammals, reptiles and amphibians of the coastal prairie communities are discussed further under Section B.2.5.1 (Terrestrial Vertebrates of the Texoma Region).

A variety of forest types are represented in western Calcasieu Parish. The bottom land forests fall into essentially three categories: loblolly pine-oak bottomland stands, cottonwood-sycamore-willow bottomland hardwoods, and cypress swamp forests. Characteristic species in the loblolly-oak association include water oak, cherry bark oak, and hawthorns along the west Fork Calcasieu River in northeastern western Calcasieu Parish and a north-south tributary of the Houston River (Bear Head Creek) in northwestern western Calcasieu Parish. Both the Houston and West Fork Calcasieu River are tributaries of the Calcasieu River. Other types of trees which may be present include other oaks (Nuttall, cow, overcup, Shumard, live) Hackberry, honey locust, elms (American and winged), magnolias, hickory, and beech.

Along the Sabine River and the Calcasieu River flood plain above Lake Charles, there are active sedimentation zones where species in the cottonwood-sycamore-willow association are found. The main types of plants in these situations are: cottonwood, American sycamore, red gum (sweet gum), black willow and sandbar willow, blackberry, sand privet, honey locust, and water locust. The willows are dominant.

Swamp forest is found in the general area of the sedimentation zones cited above but where there are more stable conditions. Representative plants include bald cypress, tupelo gum, swamp red maple, swamp oak, water ash, pumpkin ash, Virginia willow, and button bush.

Swampy, poorly-drained areas along the northern parts of western Calcasieu Parishes away from watercourses support flatwood vegetation where undisturbed. Certain oaks (Southern red, post, black-jack and willow) generally begin the forest succession after clearing or burning. Disturbed areas are frequently used as pasture. Natural vegetation includes: longleaf pine with wiregrass and palmetto, slash pine, cypress, swamp black gum, magnolia, water oak, swamp red maple, green ash, red gum, honeysuckle, huckleberry, and azalea.

Longleaf pine is managed for timber production in some sections of the flatwoods area. However, timber production is quite limited. Calcasieu Parish is one of the areas in the state which is not part of a forestry (Newton, 1972).

Dredged sediments transferred to waterway banks or used as fill have created new habitats. Main examples of the creation of such new habitats in western Calcasieu Parish include the spoil banks along the Intracoastal Waterway and the Calcasieu Ship Channel. A large island (Choupique Island) north of Calcasieu Lake and adjacent to the Ship Channel has also been built up by filling with dredged material.

The spoil banks along the ICW in western Calcasieu Parish have not been disturbed by addition of new spoil within at least the past 30 years. The total area of these disposal areas is 2,892 acres. Dredged material was placed on both sides of the waterway and is bordered by cleared, generally cultivated, land; brackish marsh; intermediate marsh, and fresh marsh. Width of the spoil areas varies from about 100 feet to 1/4 mile. The spoil is not continuous along the Waterway.

The vegetation on the banks of the ICW is dependent on several factors, including time since disturbance, drainage (as influenced by soil characteristics and elevation) and characteristics of the adjacent landscape, especially the salinity of the water. Since little disturbance has occurred for at least 30 years, succession has proceeded to a near climax situation, except on maintained rights-of-way which are periodically mowed. From 1000 feet west of Black Bayou Cutoff to the Texas border, right-of-way is maintained by the Colonial Pipeline Company. In these areas, vegetation is kept in an early state of succession by periodic mowing to maintain accessibility to their pipeline.

Dredged material areas support a wide range of species, particularly pioneer species which invade disturbed sites. Taller vegetation in these areas includes eastern baccharis or sea myrtle (Baccharis halimifolia), marsh elder (Iva frutescens), wax myrtle (Myrica cerifera), black willow (Salix nigra), roseau (Phragmites communis), rattlebox (Daubentonia texana), sweet acacia (Acacia angustissima), and bush palmetto (Sabal minor). Shrubs most frequently observed along ICW disposal areas are eastern baccharis, marsh elder, and elderberry (Sambucus canadensis). Common ground cover species along the ICW are blackberry (Rubus duplaris), roseau, ironweed (Sida rhombifolia), broomsedge (Andropogon virginicus), giant ragweed (Ambrosia trifida), common ragweed (Ambrosia artemisiifolia), and camphorweed (Pluchea camphorata). Low-lying disposal areas bordering marshlands often support thick carpets of alligatorweed (Alternanthera philoxeroides) with typical marsh species interspersed.

Old dredge material embankments bordering brackish to intermediate marsh supports vegetation different from the marsh itself, including sweet acacia, sedge (Cyperus articulatus), rattlebox, roseau, broomsedge, rushes (Juncus spp.), marsh elder, sea myrtle (Baccharis halimifolia), peppergrass (Lepidium virginicum), and vervain (Verbena brasiliensis). The most common species on disposal sites in brackish areas include marsh elder, eastern baccharis, wiregrass (Spartina patens), Bermuda grass (Cynodon dactylon), blackberry and roseau, while similar sites in the intermediate marsh are cane (Spartina cynosuroides) with roseau and soft rush (Juncus effusus) sometimes assuming dominant status.

Giant cutgrass (Zizaniopsis miliacea), elephant's ear (Colocasia antiquorum), and black willow often dominate the fresh marsh/canal interface along the ICW, with willow invasion common in

some areas where water levels are decreasing. Although black willow dominates most ICW disposal areas in fresh marsh situations, tallow tree (Sapium sebiferum) often dominates some of the better-drained disposal areas.

Some dredged material disposal areas along the ICW are currently being managed for improved pasture with vegetation being similar to other managed coastal pastures, including such species as Bermuda grass, St. Augustine grass (Stenotaphrum secundatum), white clover (Trifolium repens), reversed clover (Trifolium resupinatum) and various weedy annuals.

Dredging along the Calcasieu Ship Channel north as far as the salt water barrier, which spans Calcasieu River above Lake Charles, occurs on a variable basis. Spoil banks in various stages of revegetation are present along nearly the entire extent of this channel in western Calcasieu Parish in close proximity to the lakes (Moss Lake, Prien Lake, Lake Charles) along it. Revegetation results in generally the same plant types as those present on spoil banks along the ICW. Plant populations usually develop within 12 to 18 months following deposition of new sediment.

A number of canals have been dredged in approximately the southern two-thirds of western Calcasieu Parish. The levees produced as a result support vegetation similar to that of natural levees (U. S. Army Corps of Engineers, 1975), if they are not mowed. This generally can include loblolly pine, water oak, cherry, bark oak, overcup oak, red gum, persimmon, hackberry, and butter pecan and other trees (Newton, 1972).

As mentioned, brackish, fresh, and intermediate marsh types are present along the Intracoastal Waterway. They also extend away from the Calcasieu River and the lakes on it in Calcasieu Parish and away to a limited distance inland from the channels of other water courses connected to the river and lakes. The biota of these marsh types has been discussed in the regional environmental description pertaining to western Cameron Parish (Section B.2.5.2.1 and Appendix K.1, Table K.1-2, vertebrates of the Texoma region except fish (Section B.2.5.2.5, commercially important animals (Section B.2.5.4.2), and recreationally important species (Section B.2.5.5).

The Calcasieu River; lakes on it; tributary bayous and canals; the tributaries, the Houston River and the West Fork Calcasieu River; and branches of tributaries are the main bodies of

water in western Calcasieu Parish. A few small natural lakes and impoundments are also present. Most of the runoff in western Calcasieu Parish is toward the Calcasieu estuary, rather than that of the Sabine.

The Calcasieu River within the parish is generally brackish from the southern boundary north to Lake Charles, although the salinity fluctuates greatly. Salinity intrusion above this level is less frequent and is presently controlled during the rice growing season by closing the gates in a salt water barrier near the town of Westlake. The Sabine River is also sometimes brackish for some distance north past the southern boundary of Calcasieu Parish.

Depending on salinity and other conditions, estuarine-dependent, somewhat salinity-tolerant freshwater, and salinity-intolerant freshwater biota are present in the water bodies. Estuarine-dependent or characteristic fish and invertebrates are generally present northward into Lake Charles on the Calcasieu River. These estuarine forms have been described in the section on western Cameron Parish (B.2.5.2.1) and Appendix K.2, Table K.2-1.

Many of the freshwater fish which are expected to be present are listed along the types of habitats with which they are associated within Appendix K.5, Table K.5-1. Major forms include blue and channel catfish (Ictalurus furcatus and I. punctatus), largemouth bass (Micropterus salmoides), sunfish (Lepomis spp.), gar (Lepisosteus spp.), mosquitofish (Gambusia affinis), Fundulus spp., freshwater drum (Aplodinotus grunniens) and buffalo (Ictiobus spp.).

Sunfish have their development limited by about 5% salinity and adults found at this salinity and above generally are stunted. Catfish can spawn at up to 2 ppt successfully but generally are reproductive at mostly lower salinity levels. These fish become more tolerant of salinity as their development proceeds. Largemouth bass cannot reproduce at salinities above 5 ppt and usually spawn in locations where salinities are 3 ppt or less. The other main species listed also generally spawn in low salinity, if not fresh water. However the alligator gar is more tolerant.

A partial list of fish collected from the Sabine River is presented in the section on Important Recreational Species in the Region (B.2.5.5). Calcasieu Parish and Orange County share the Sabine River as a common border. A discussion appears in the description of Orange County Ecosystems (Section B.2.5.2.3). Data on Sabine River plankton

and benthic fauna are also presented in the Orange County discussion. Brackish water benthic plants and animals have been discussed in the western Cameron Parish ecosystem description (Section B.2.5.2.1).

Benthic invertebrates collected near the generally brackish ICW in western Calcasieu Parish included the mollusk Pseudocyrena floridana; the oligochaetes, Limnodrilus sp. and Peloscolex sp.; the polychaetes, Loandalia fauveli and Sabellides oculata; the amphipod, Gammarus sp.; and the dipteran, Chironomus sp. (U. S. Army Corps of Engineers, 1975). The ICW is near the southern boundary of the parish. Dipterans (flies, mosquitos, midges, and gnats) are among the most important aquatic insects. Many larval midge species are benthic, but mosquitos are found in the water column near the surface. The phantom midge migrates between the bottom and other parts of the water column. The majority of fly and gnat species are terrestrial during all life stages. Common midges include: Pentaneura, Tendipes, Procladius, Cryptochironomus, Coelotanypus and Polypedilum. Other benthic larval insects include dragonflies (e.g., Cannacria, Erythemis, Pachydiplex, and Perithemis), damselflies (Enallagma and Ischnura), mayflies (Ephemeroptera), caddis flies (Trichoptera), and dobson flies (Megaloptera). Mature insects, most of which are not benthic include such forms as giant water bugs (family Belostomatidae), water scorpions (family Nepidae), backswimmers (family Notonectidae), water striders (family Gerridae), water boatmen (family Corixidae), and ripple bugs (family Velidae). This information on insects was assembled by the U. S. Army Corps of Engineers (1975).

The insects are significant components of freshwater food webs. The benthic ones are generally scavengers, but many of the others are predators. Other benthic animals important in freshwater habitats include crayfish (Procambarus clarkii; P. blandingi; species in the genera Orconectes, Cambarus, and Cambarellus). The crayfish feed on a variety of organic materials including decomposing material in detritus. They are used as food by fish, turtles, snakes, raccoons, mink, man, and other vertebrates (U. S. Army Corps of Engineers, 1975).

Other important freshwater benthic groups include oligochaetes (e.g., tubificids or sludgeworms), isopods (Cyathura and Edotea), amphipods (Corophium, Acanthohaustorius, Monoculodes, Orchestia, Hyaella, Gammarus), leeches e.g., (Placobdella, Macrobdella, and Piscicola), and mollusks (Littorina and Corbicula). These benthic animals feed mainly on detritus and bacteria and algae except for the leeches which parasitize vertebrates (Corps of Engineers, 1975)).

Regional vertebrates except fish, are discussed separately in Section B.2.5.2.5 (Terrestrial Vertebrates of the Texoma Region). The discussion is by the habitat types with which these vertebrates are associated. Commercially important species are discussed in Section B.2.5.4.2 and recreationally important species are discussed in Section B.2.5.5.

Phytoplankton collected from the Intracoastal Waterway include diatoms, blue-green algae, green algae, and yellow-green algae. The diatoms included: Navicula spp., Cyclotella sp., Melosira granulata, small unknown pennates, Nitzschia seriata, Melosira varians, and Synedra ulna. The blue-greens included Anabaena sp., Chroococcus sp., and Nostoc sp. The green alga was Shroederia setigera and the yellow-green (Chrysophyceae) was Dinobryon sp. Phytoplankton data are not available for most of the fresh water bodies of western Calcasieu Parish. Diatoms and blue-green, and green algae have been reported from the Sabine River, as discussed in Section B.2.5.2.3 (characteristics of ecosystems in Orange County).

The most common phytoplankters in standing and slowly moving water identified in a study in eastern Louisiana included the diatoms, Melosira spp., Coscinodiscus spp., and Pleurosigma spp.; the green algae, Scenedesmus spp., Pediastrum spp. and Staurostrum spp.; and the blue-green algae, Anabaena spp. and Oscillatoria spp. (U. S. Army Corps of Engineers, 1975). Other genera which may be present include the diatoms, Asterionella, Tabellaria, and Fragilaria; Chrysophyceae such as Dinobryon and Uroglena; colonial green algae such as Volvox, Pandorina, and Eudorina; dinoflagellates such as Ceratium and Peridinium; and others (Hutchinson, 1967).

For the most part these algae may also be present in somewhat brackish to brackish water. The phytoplankton of these higher salinities have been discussed in Section B.2.5.2.1 (Characteristics of Ecosystems in Western Cameron Parish).

Zooplankton collected from the Intracoastal Waterway included copepods, cladocera, rotifers, ostracods, and miscellaneous forms. The copepods included the calanoids, Eurytemora affinis, a Diaptomus species, and copepodids; the cyclopoids, Eucyclops agilis and unidentified copepodids; and unidentified nauplii. The Cladocera included Bosmina coregoni, Daphnia pulex, Chydorus sphaericus, Alona monacantha, Eurycercus lamellatus, and three unidentified species. The rotifers included Brachionus bidentata, Keratella cochlearis, Asplanchna sp., Lecane luna, and an unidentified species. Other plankters noted included an ostracod species and miscellaneous unidentified

forms. These groups are a freshwater assemblage and probably representative of the freshwater zooplankton throughout most of western Calcasieu Parish. Brackish to marine zooplankton are discussed in Section B.2.5.1.1 (Characteristics of Ecosystems in Western Cameron Parish) and most are listed in Appendix K.4, Table K.4-1.

B.2.5.2.3 Characteristics of Ecosystems in Orange County

Meanderbelt sand deposits together with barrier-strand-plain sediments form the basis for tree-covered belts extending northward from a southern strip of marshlands which border Sabine and Neches Rivers and an acre of prairie to the north of the marshlands. The meanderbelt sand has developed into mature, permeable, well-drained soils which support pine-hardwood forest. The barrier-strandplain deposits in the north-central part of the county support extensive oak cover.

Prairie areas in the county are found on mud-based soils. Local inland stretches of prairie with grasses and scattered trees are the climax above floodplain mud sediments which were deposited between the meanderbelt sand soils discussed above. Deltaic intertributary mud and clay represent the origin for the largest amount of prairie soil in the county. This origin for prairie is typical for the eastern part of the county while prairie stemming meanderbelt from floodplains is mainly in the western half. Intertributary prairie soils are dark, fertile, and highly productive when employed as cropland. The abandoned distributary channels are filled in with mud for the most part. Pines and hardwoods grow in the sand and silt soils formed from those parts of the ancient distributary channels which are still exposed. Otherwise, the natural vegetation of the filled in channels is prairie continuous with adjacent intertributary prairie.

The trees in the forest systems and the grasses of the prairie systems in the county are essentially the same as those listed for similar systems in western Calcasieu Parish (Section B.2.5.2.2). The general forest types and representative organisms in the forest types are given in Figure B.2-19. Marsh and prairie areas are also shown on the same figure.

Delta mud compaction and subsidence has occurred in the marsh areas along the Sabine and Neches Rivers in the southern part of the county. The mud and restricted to local areas, sand parent materials have been greatly altered by accumulations of organic material from the marsh vegetation. This marsh area is greatly altered along the Sabine and Neches River banks and

B. 2-64

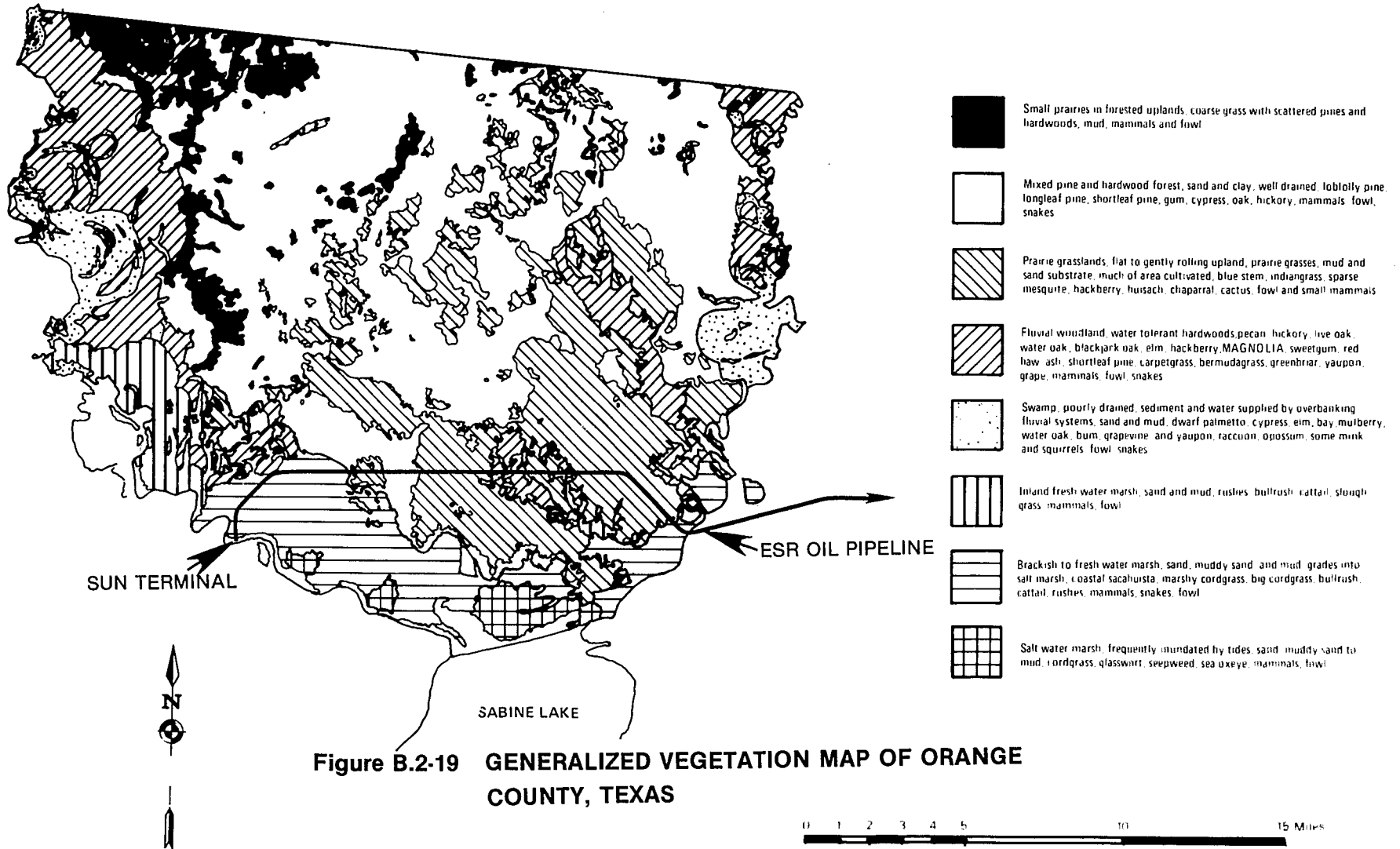

the banks of Cow and Adams Bayou by dredged spoil disposal banks in various stages of succession. A plant species composition is present in such areas which is similar to the species mentioned as present on dredge disposal areas in western Calcasieu Parish (Section B.2.5.2.2). The organisms characteristic of the different marsh types have been discussed in relation to western Cameron Parish except for a distinctive vegetation assemblage called high marsh present on higher elevations within the general marsh area. This assemblage includes ferns, grasses, trees and weeds and weed-like species. These are listed in Table K.6-1, Appendix K.6. Vertebrates apart from fish are discussed in Section B.2.5.1.5 (Terrestrial Vertebrates of the Texoma Region).

Typical recreationally important fish from the Sabine River are listed in Section B.2.5.4.2. These collections were made upstream of Orange County below the Toledo Bend Reservoir. Other fish recorded from the same location include: the spottail shiner, bullhead minnow, gizzard shad, chestnut lamprey (attached to smallmouth buffalo), threadfin shad, Hybognathus sp., speckled chub, golden shiner, emerald shiner, ghost shiner, red shiner, Sabine shiner, redfin shiner, blacktail shiner, mimic shiner, pugnose minnow, suckermouth minnow, mosquitofish, blackstripe topminnow, blackspotted topminnow, western sand darter, scaly sand darter, and the river darter (Lantz, 1970). Salinity-tolerant or estuarine fish which might be present in watercourses and nonfresh marshes in the southern part of the county have been largely discussed in connection with western Calcasieu (Section B.2.5.2.2), and western Cameron Parish (Section B.2.5.2.1).

Lantz (1970), surveyed plankton and benthos in the Sabine River as well as fish. The following results of the survey are from a station approximately 18 air miles north of the junction of the Intracoastal Waterway with Sabine Lake.

Net plankton counts and net and nannoplankton* concentrations (gm/m^3) are given in Table B.2-5 and Figure B.2-20 respectively, for this location. Net plankton counts and weights (a no. 25 net was used), were lowest during late fall and winter of each year with productivity increasing by February of each year. However, during the warm months productivity is variable, with counts and weights showing sporadic pulses with no predictable trend toward summer maximum productivity. Similar trends were seen for nanno plankton weights. Mean study gravimetric results showed $.124 \text{ gms}/\text{m}^3$ for net plankton as opposed to $3.496 \text{ gms}/\text{m}^3$ for nanno plankton. Rotifers, especially the genus Keratella, dominated the zooplankton during peak occurrence of zooplankton.

*nannoplankton - Plankton which pass through a #25 bolting cloth Wisconsin style plankton net. Net plankton are retained by this size net.

Table B.2-5

MONTHLY NET PLANKTON COUNTS PER LITER FROM SABINE RIVER

Organism	1964				1965											
	Sept.	Oct.	Nov.	Dec.	Jan.	Feb.	Mar.	Apr.	May	June	July	Aug.	Sept.	Oct.	Nov.	Dec.
<i>Zooplankton</i>																
Cladocera								2		1						
Copepoda						2		2		1						
Nauplius																
Rotifera							100	100								
TOTAL	0	0	0	0	0	2	100	104	0	2	0	0	0	0	0	0
<i>Phytoplankton</i>																
Chlorophyta		100						2800	300		100					
Chrysophyta						200				500	100			900	100	30
Cyanophyta		300	200						400	100						
Euglenophyta	100															
TOTAL	100	100	200	0	0	200	0	2800	700	600	200	0	0	900	100	30
<i>Organism</i>																
Organism	1966												1967			
	Jan.	Feb.	Mar.	Apr.	May	June	July	Aug.	Sept.	Oct.	Nov.	Dec.	Jan.	Mar.		
<i>Zooplankton</i>																
Cladocera				1		2								5		
Copepoda			1													
Nauplius				1	5										5	
Rotifera				300											100	
TOTAL	0	0	1	302	5	2	0	0	0	0	0	0	5	105	0	
<i>Phytoplankton</i>																
Chlorophyta	200		100			200	100	100						100	200	
Chrysophyta	100		1100				100		100	200	200	100			1500	
Cyanophyta							300				100		100			
Euglenophyta																
TOTAL	300	0	1200	300	0	202	500	100	100	300	200	200	100	1700		

Source: Lantz (1970).

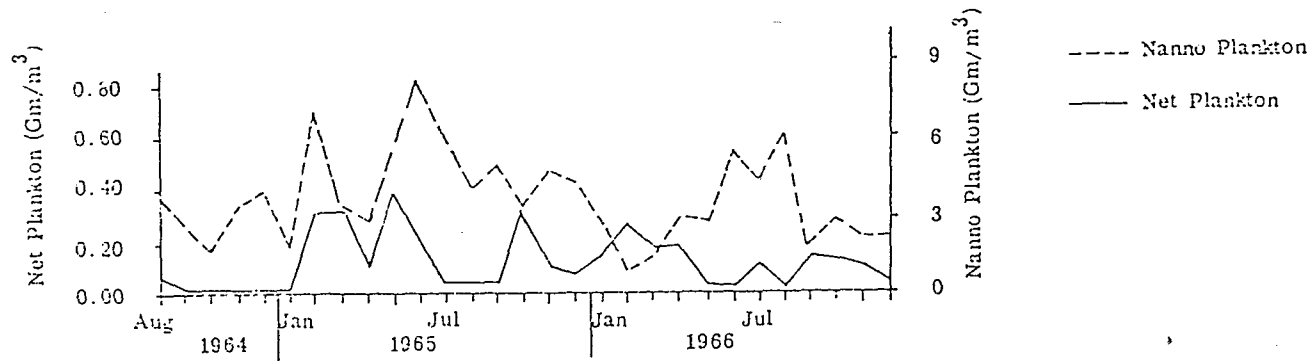

Monthly Variations of Weight (Gm/m³) of Net and Nanno Plankton at Station IV of Sabine River

Figure B.2-20

Source: Lantz (1970).

Chrysophyta (yellow-green algae), was the dominant algal group, with high counts of Pennales sp. and lesser numbers of Synura sp. during phytoplankton pulses. Other algal groups represented were Chlorophyta (Green algae) and Cyanophyta (blue-green algae), with the former present during three to four months of the year and represented by species of Spirulina and Chroococcus.

Table B.2-6 represents pigment analysis for the lowest station of Lantz's study (Lantz, 1970) and indicates plankton pulses in the Sabine River varying from month to month, with the lack of an extended period of plankton productivity during the spring and summer of each year probably associated with stream discharges of turbid waters during periods of high flow.

Data are also presented on the bottom fauna in Table B.2-7. The major groups represented were the Tubificidae (a family of Oligochaete worms), and Chironomidae (midge larvae). Data were not adequate to determine productivity.

Table B.2-6

PHYTOPLANKTON PIGMENTS FROM STATION IV OF SABINE RIVER*						
Month	<i>Chlorophyll a</i>	<i>Chlorophyll b</i>	<i>Chlorophyll c</i>	<i>Carotenoid ac</i>	<i>Carotenoid nac</i>	
August, 1964	3.94	1.16	3.62	0.32	0.64	
September	
October	1.86	0.54	0.84	0.20	0.44	
November	0.92	0.55	1.58	3.01	0.35	
December	2.15	0.83	4.15	0.48	0.03	
January, 1965	2.44	0.92	1.82	0.44	0.12	
February	1.53	0.83	2.01	0.39	0.02	
March	4.80	3.35	16.50	2.68	1.49	
April	3.16	1.00	4.62	0.72	0.01	
May	2.45	1.81	3.87	0.76	0.15	
June	0.68	0.57	1.78	0.05	0.13	
July	0.77	0.71	1.60	0.22	0.14	
August	1.59	1.62	2.22	0.42	0.11	
September	2.60	1.59	3.48	0.47	0.03	
October	
November	0.95	1.08	1.61	0.29	0.19	
December	1.08	1.22	1.29	0.30	0.06	
January, 1966	0.85	0.53	0.29	0.19	0.05	
February	0.65	0.70	1.17	0.09	0.07	
March	2.03	1.97	1.48	0.21	0.22	
April	0.23	0.23	0.00	0.00	0.00	
May	
June	5.21	4.66	3.06	0.37	0.72	
July	2.22	2.20	1.18	0.16	0.37	
August	3.20	2.93	2.12	0.35	0.40	
September	2.79	2.31	0.49	0.21	0.28	
October	2.70	2.31	0.49	0.24	0.28	
November	1.25	1.07	2.13	0.20	0.05	
December	0.96	0.83	0.57	0.11	0.02	
January, 1967	1.22	1.12	1.05	0.17	0.04	
Mean	2.01	1.43	2.41	0.48	0.24	

*Milligram per liter (mg/l)—chlorophyll a and chlorophyll b values

Milligram specific pigment units (MSPU)—chlorophyll c, carotenoid ac and carotenoid nac values.

Source: Lantz (1970).

Table B.2-7

SEASONAL COUNTS, WEIGHTS, AND VOLUMES OF BOTTOM FAUNA
FROM SABINE RIVER

<i>Organism</i>	<i>Fall</i> <i>1964</i>	<i>Winter</i> <i>1964-65</i>	<i>Spring</i> <i>1965</i>	<i>Summer</i> <i>1965</i>	<i>Fall</i> <i>1965</i>	<i>Winter</i> <i>1965-66</i>	<i>Spring</i> <i>1966</i>	<i>Summer</i> <i>1966</i>	<i>Fall</i> <i>1966</i>	<i>Winter</i> <i>1966</i>
Tubificidae	63	2	14	..	6	1	..	4
Odonata	2	1	2
Ephemeroptera	20	3	..	4
Trichoptera	3	..	2
Coleoptera	3
Chironomidae	1	..	1	..	38	1	..	18
Viviparidae	1	..	1	..	1	..	1
Unionidae
Gammaridae	3	..	2	14	..	2
TOTAL (no./ft ²)	90	2	21	3	45	57	23	26
Weight (gm/ft ²)	0.091	0.002	3.742	0.003	0.015	0.071	0.248	0.019
Volume (cc/ft ²)	0.02	0.21	2.10	0.10	0.20	0.20	0.40	0.20

Source: Lantz (1970).

B.2.5.2.4 Characteristics of Ecosystems in Jefferson County

Jefferson County is located in southeast Texas on the Texas-Louisiana border. The county is bounded on the south by the Gulf of Mexico.

Ecosystems distribution in the county is partially determined by elevation and proximity to the Gulf. Ecosystems extend in a transition from lowland salt and brackish water marshes near the coast, through brackish-to-fresh water marsh systems which occur further inland, to prairie grassland systems of central Jefferson County, and finally into the mixed pine and hardwood forests of the upland areas of northern Jefferson County. The distribution of these ecosystems are shown in Figure B.2-21. A general textual discussion of each ecosystem type is presented later in this section. Total acreage for each ecosystem as well as the dominant plant species are listed in Appendix K.7. Table K.7-1. Terrestrial vertebrates are discussed in Section B.2.5.2.5.

Several aquatic ecosystems occur within Jefferson County or in the offshore areas through which brine disposal pipelines would be placed. The floral and faunal composition of these aquatic ecosystems is related to the salinity regimes present. These water bodies are both natural and constructed.

The natural water systems include three zones in the Gulf of Mexico; Sabine Lake (10 to 20 ppt average salinity); and fresh-to-brackish water bodies which include lakes, ponds and sloughs of abandoned channels. Many of the fresh-to-brackish water ponds and lakes occur in the coastal lowlands between the ICW and the Gulf in the southern portion of Jefferson County. These lakes and ponds are landlocked but they accumulate salt water following high tides and storms.

The principal fresh water streams of the area are the Neches River, which marks the eastern border of Jefferson County, Taylor Bayou, and the Hillebrant Bayou. They are influenced by tides in their lower reaches and are classified as estuarine in these areas.

Artificial water bodies include canals and reservoirs, which generally contain fresh water, and the ICW, which is brackish. Much of the county's area which is covered by reservoirs is in the J. D. Murfee State Wildlife Management Area.

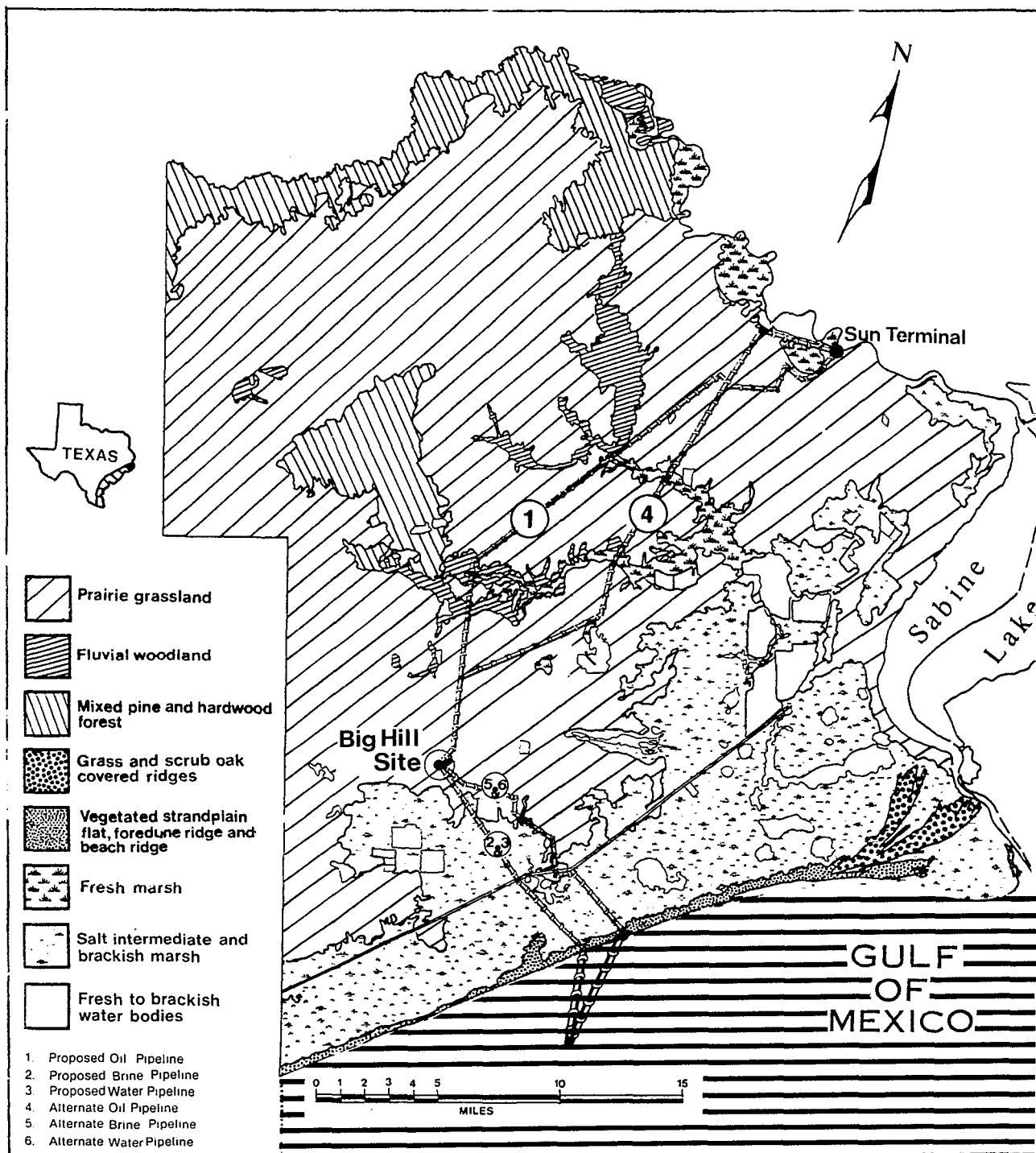

Figure B.2-21 ECOSYSTEM DISTRIBUTION, JEFFERSON COUNTY, TEXAS

Source: Fisher, et al. 1973

Table K.7-2 in Appendix K.7, lists the dominant floral and faunal species for the aquatic ecosystems in or directly offshore of Jefferson County. These and the other ecosystems of the county are described in detail in the following sections.

Prairie Grasslands

Of the 951 square miles (608,704 acres) in Jefferson County, 577 square miles were prairie grassland in their natural state. Most of this prairie land has been converted to cropland and pastureland.

Prairie vegetation is dominated by tall grasses, but trees and brush are found in scattered areas on higher ground and around residences. Dominant species of mammals include rabbits and rodents, and domestic livestock which graze on the prairie grasses. Birds in this area include several species of upland game birds and numerous sparrows and black birds. Soils on this terrain are clayey in texture, with high water holding capacity and poor drainage characteristics.

Cropland

Fifty-four percent of the land in Jefferson County is farmland, most of which has been developed in the prairie grassland areas of the county (Fisher, et al., 1973). Crops include rice, soybeans and hay. The fauna tends to include species immigrating from surrounding ecosystems and is similar to that of the prairie grasslands. Rice fields are favorite feeding grounds for geese and ducks in winter months and these areas are often used for hunting activities.

Pasturelands

Much of Jefferson County is used for beef cattle grazing. These cattle are primarily mixed-breed Brahmans which are hearty enough to resist insect and humidity problems (Kelly, 1977).

Much cattle grazing occurs in the prairie grassland systems, but cattle are also grazed on cordgrass and other components of the low lying marsh ecosystems along the coast. The marsh systems have low productivity in terms of cattle grazing with as much as 20 acres required to sustain one steer (Kelly, 1977).

Wooded Assemblages

Three ecosystems in which the vegetation is dominated by trees are found in Jefferson County (See Figure B.2-21). These habitats are swamps, fluvial woodlands, and the mixed pine-hardwood association. Swamps, which extend inland from freshwater marshes, have developed in poorly drained, high water table areas adjacent to major streams. Fluvial woodlands are usually found slightly upland to or further away from a water body than swamps. They contain water-tolerant,

as opposed to water-dependent plants. The third wooded ecosystem occurs primarily in the upland regions of northern Jefferson County and consists of mixed pine and hardwood associations, as opposed to water dependent plants.

Approximately 3,840 acres of land in Jefferson County are covered by swamps (Fisher, et al., 1973). They occur primarily along the upland reaches of the Neches River and Taylor Bayou. The frequency and duration of inundation by water of these areas are major factors in determining species composition. Species are listed in Table K.7-1, Appendix K. A distinction should be made between deep swamps, which are perpetually inundated, and which are dominated by bald cypress, water tupelo and water weeds; and shallow swamps, in which soils are better drained and the duration of inundation is shorter. Species which dominate these swamps include swamp tupelo, oaks, hickories, willow, and pecans.

Fluvial woodlands are found on the better-drained bottomland sites, which include transition areas from flats to ridges. Approximately 3.5 percent of Jefferson County is covered by this wooded ecosystem (Fisher, et al., 1973). Major plant species, which are listed in Table K.7-1, Appendix K are adapted to less soil moisture than species found in the swamp systems.

More than 8 percent of the land in Jefferson County is pine and hardwood forest (Fisher, 1973), (See Figure B.2-21). The dominant plant species many of which are important commercially, are listed in Table K.7-1, Appendix K.7. The vegetation types consist of mixed pine and hardwood association, and are found primarily in the upland north and northeast portions of the county. This association is broken periodically by small prairies which support the grass associations of the prairie grassland ecosystems. Extensive stands of oak are present in Lawhorn Woods, which is located in the west-central part of the county.

Marshlands

Jefferson County includes approximately 128,000 acres of marshlands. Four distinct marsh types, based primarily on the vegetation within the areas, have been designated as (1) fresh marsh, (2) intermediate marsh, (3) brackish marsh, and (4) salt marsh (Chabreck, 1972). Species in these marsh types are presented in Table K.1-2, Appendix K. Intermediate marsh is the most extensive marsh type for Jefferson County, followed by brackish marsh, fresh marsh, and saline marsh.

Salt marshes contain few plant species, but with inland succession from salt to fresh water marshes, species diversity and associated habitat complexity increases significantly. Chabreck noted a five-fold increase in the number of plant species between salt and fresh water marsh systems in Louisiana (Chabreck, 1972).

Many aquatic animal species use the marshes as nursery areas. Fishing, crabbing, shrimping and shellfishing operations in the area are indirectly dependent on these marshes because marshes provide suitable habitat for the young of commercial species which later move into open water areas of the estuaries and offshore.

These marsh areas provide wintering grounds for several million ducks and geese, and provide permanent habitat for muskrat, deer, nutria, mink, racoons (Soil Conservation Service, 1965). Most waterfowl food plants are confined to fresh and brackish water marshes and to other fresh water bodies and therefore the salt marshes are used only to a limited extent by migratory waterfowl.

Detritus from the marshes furnishes the main basis of the food web. Phytoplankton may sometimes be locally abundant, but are never dominating as on offshore areas. In general, their numbers and species diversity are low.

Zooplankton feed either on detritus, phytoplankton, or on each other and are fed upon in turn by the larger members of the marsh food web.

Insects are also important members of the food web. Many commercial and sport fishes, small mammals, birds, reptiles and amphibians depend on them as a major food source. Such insects are largely restricted to terrestrial forms which feed on vegetation above the water line in areas where the water is appreciably saline.

Salt marsh occurs along the extreme coastal areas of Jefferson County and also along the lower reaches of the Neches River where it flows into Sabine Lake. The species present include saltgrass, wiregrass, and saltwort. In spite of the fact that the number of species in salt marshes is low, these marshes are considered to be highly productive areas and are an integral component of the food webs of the Gulf-estuarine complex. Dominant species are listed in Appendix K, Table K.1-2.

Brackish marsh covers approximately 6 percent of the land in Jefferson County (Fisher, 1973). These marshes have a wide salinity range of approximately 3 to 18 ppt with an average at about 8.1 ppt. Wiregrass is generally considered to be the dominant species. Other species include rushes and grasses.

Plant species found in brackish marshes are indicated in Appendix K, Table K.1-2. Brackish marshes have secondary production which is equal to or greater than that of saline marshes, and may be especially important as a nursery area for shrimp and fish. Tidal influences are less significant and water depths are usually greater in brackish marshes than in saline marshes. In general, the flora of the brackish marsh is more diverse than that of the saline marsh.

Intermediate marsh is the most predominant marsh type in Jefferson County, covering 12.5 percent of the total acreage, (Fisher et al., 1973). These marshes contain wiregrass, deerpea, wild millet, bullwhip, and sawgrass. A more complete species list is presented in Appendix K, Table K.1-2. The areas are characterized by a plant community with greater diversity than that of salt or brackish marshes and relatively lower salinities.

Fresh marshes cover approximately 9.5 thousand acres of land in Jefferson County (Fisher et al., 1973). Fresh water marshes border on cypress swamps, with occasional baldcypress trees extending into the marsh area. Herbaceous plants characterizing this marsh type include cattail, roseau, arrowhead, pickerelweed, softstem bulrush, water hyacinth, marsh elder, and palmetto. Willow thickets are common in some of the marshes. Some of the other species present are listed in Appendix K, Table K.1-2.

Waterway Banks and Dredge Spoil Areas

A one to two hundred-foot wide spoil bank of dredge material forms the banks of the ICW. These banks have an elevation which is greater than that of the surrounding marshland. Dredge material is also found adjoining the spoil banks and on some areas averages 40-60 acres per mile. The width of these dredge material disposal areas in the vicinity of the proposed Big Hill pipeline crossing is approximately 1,500 feet.

The vegetation on the banks of the ICW is dependent on several factors, including time since disturbance, drainage (as influenced by soil characteristics and elevation), and characteristics of the adjacent landscape, especially the salinity of the water. The dredge spoil embankments bordering the ICW are relatively barren areas. They are used locally for fishing, and provide resting areas for waterfowl. Where succession has occurred, the vegetation is different than that of the surrounding brackish and intermediate marsh.

Dredge material disposal areas support a wide range of species, particularly pioneer species which invade disturbed sites. Low lying disposal areas which border the marshlands often support thick carpets of alligator weed with typical marsh species interspersed.

Ocean Ecosystems

Three fairly distinct open-water ocean ecosystems are associated with the Big Hill facility. They are: upper shoreface, shoreface, and shelf. Species are listed in Table K.7-2, Appendix K.

The upper shore face is characterized by a sandy bottom, strong wave action, a surf zone, and shifting sands. The principal benthic animals include: clams, snails, urchins, starfish, and mud shrimps. This area extends to a depth of about 15 feet.

The shoreface is an undifferentiated zone, adjacent to the ebb tidal delta. The bottom type is predominately mud with a sparse amount of sand and shell debris. The benthic assemblage is a composite of unvegetated coastal mudflats which includes clams, Anachis snails, marine worms, crustaceans, and inner shelf fauna. The depth in this area ranges from low tide to about 30 feet.

The inner shelf has a depth greater than 30 feet with a mottled-mud bottom and a diverse faunal assemblage. The principal genera include clams, snails, starfish, and urchins.

Fresh to Brackish Water Lakes and Ponds

Jefferson County has approximately 29 square miles of fresh- to brackish-water bodies which include land locked ponds and lakes; the majority of which are located in the coastal brackish-water marsh zone. These water bodies are shallow and increase in salinity following high tides and storms. The ponds have vegetational characteristics similar to marshes of corresponding salinities. The many fresh and brackish water lakes, ponds, canals, and bayous sustain fish, alligators, turtles, insects, and crayfish (Soil Conservation Service, 1965).

Estuaries

Sabine Lake is the principal brackish-water body in the project area. The lake covers 100 square miles, less than 50 percent of which is located in Jefferson County. It is classified as bay or estuary with a salinity content ranging from 16-20 ppt at Sabine Pass to near 0 ppt at the northern end of the lake,

near the mouths of the Sabine and Neches Rivers. Variations in salinity are due to tidal and aeolian (borne or deposited by the wind) factors, as well as the fluvial hydrologic regime of the drainage basins of the Sabine and Neches Rivers. Species composition is affected by these salinity characteristics. Unlike most estuaries it does not have a large diversity of environments. Oyster reefs are not present in Sabine Lake.

The bottom substrate of Sabine Lake has been changing in recent years from predominantly sand and shell with a scattering of mud to mostly mud, especially in the western portion of the lake. This is due to a large extent to spoil deposition with subsequent erosion, and runoff from dredged materials which were not properly leveed. Other causal agents involve the failure of the levees surrounding disposal areas and the altered circulation patterns resulting from ill-advised placement of spoil. The high turbidity resulting from these activities has caused a rather severe reduction in the number of benthic organisms in the Sabine-Neches Water area.

Since 1966, there has been a precipitous decline in the annual white shrimp harvest from Sabine Lake. In 1973, no white shrimp were recorded as being harvested from Sabine Lake. The lake is, however, the third largest producer of crabs in Texas (1,358,200 pounds annually).

Reasons for the loss in the shrimp harvest include the loss of shallow water nursery grounds (marshes), increases in pollution, and disruption of benthic habitat. The estuaries in this area are potentially highly productive ecosystems. They receive nutrients from uplands via major river systems with heavy amounts during spring flooding and the nutrient wash-out from tidal flushing of the salt marsh. This is at an especially high level in mid-winter when the marsh grass of the previous season is decomposing. Another factor which has been linked to the decline in shrimp harvests is a change in salinity conditions resulting from the operation of Toledo Bend Dam. Release of water during the late spring and summer lowers salinities in the lake when the natural pattern was for them to increase.

Estuaries have a role of importance linked to that of the coastal marshes. Many commercially important species are dependent upon these systems for all or part of their life cycles. Five categories of fish utilizing estuaries are:

1. Freshwater fish visiting brackish waters.
2. Fish whose entire life cycle is spent within the estuary.
3. Anadromous fish.
4. Marine fish utilizing the estuaries as feeding or nursery areas.
5. Occasional visitors.

Many species of commercially important fish are associated with Southeast Texas estuaries. These fish generally are marine forms which use the estuaries as feeding or nursery areas. A number of small fish (killifish, gobies, toadfish, and sleepers) spend their entire life cycle in the estuary. Anadromous species, such as shad, are common in these waters, while some marine fish, such as sharks and rays only visit the estuaries occasionally.

The blue crab, brown and white shrimp, sergestid shrimp, mysids, bivalve molluscs, and polychaete worms are abundant in the estuaries. Amphipods, xanthid crabs, sponges, bryozoans, and gastropod molluscs are also present. Several species of large invertebrates are important to the economy of the study area. Blue crabs, brown and white shrimp, and oysters all use the brackish waters as a nursery. Other invertebrates live in the marsh grass or on the mud flats, where they are subject to tidal flooding. Such animals, include fiddler crabs, mud crabs, hermit crabs, marsh periwinkles, olive nerites, ribbed mussels, and the coffee melampus. Dominant plant of the estuarine ecosystems are listed in Table K.7-2, Appendix K.

Fresh Water Rivers and Streams

The major fresh-water bodies within the study area are the upper Neches River and the upper portions of Taylor Bayou. In addition Jefferson County has about 4 square miles of elongate sloughs formed from abandoned loops and channels of older streams. There are also several elliptical oxbow lakes in the Neches River Valley formed from abandoned river channels.

Representative species of organisms identified from the Sabine River drainage area or from other fresh-water bodies similar to those in Jefferson County are listed in Table K.7-2, Appendix K. The kinds of organisms present include clams, benthic crustaceans, immature insects (larvae and naiads), phyto- and zooplankton, higher plants and fish. Plankton production is mainly initiated in standing or slow moving water.

B.2.5.2.5 Ecosystems - Terrestrial Vertebrates

Mammals

A number of species of mammals inhabit the Texoma study area. Muskrats (Ondatra zibethicus) are abundant in the rice fields and marshes throughout the area, with brackish marsh the preferred type. Nutria (Myocaster coypus), are most abundant in the fresh and intermediate coastal marshes of Jefferson County and where it feeds on marsh vegetation. Both muskrats and nutria are also common along lakes, streams and canals, making use of the dredged material banks as refuges when water levels are high. Their burrowing often causes damage to the levee/bank system. Mink (Mustela vison), are most common in the cypress-tupelo swamps along the Sabine and Neches Rivers, but also occur in marshes where some high ground is available for refuge. The raccoon (Procyon lotor), occurs in brackish and fresh marshes, swamps, and bottomland forests, also utilizing disposal areas seasonally for feeding and refuge from high waters. River otters (Lutra canadensis), which are not common in the area, seek permanent open water areas with intermittent high ground. They occur in a variety of aquatic habitats but prefer fresh to brackish marsh. White-tailed deer prefer the bottomland forest, especially where an ecotone with cleared land is available, but they are also found in the marshes where they seek high ground during periods of high water. Highest populations of the deer are found in Calcasieu Parish.

Two species of rabbits are common in the Texoma area. The eastern cottontail (Sylvilagus floridanus), is found mainly on well-drained woodlots, along fence rows, and in old fields. The swamp rabbit (Sylvilagus aquaticus), is generally found in wet woodlands and marsh ridges and is more common in the southern part of the study area. Two common species of squirrels the eastern gray squirrel (Sciurus carolinensis), and eastern flying squirrel (Glaucomys volans), are typical of woodlands, with the gray squirrel preferring the dense bottomland hardwood and swamp forests and the flying squirrel found in drier, less dense woodland. Skunks (Spilogale putorius and Mephitis mephitis), opossum (Didelphis virginiana), the nine-banded armadillo (Dasypus novemcinctus), cotton mouse (Peromyscus gossypinus), and hispid cotton rat (Sigmodon hispidus), are also found in the bottomland forests. Major predators in these bottomland and swamp forests include the bobcat (Lynx rufus), with the red and gray foxes (Vulpes fulva and Urocyon cinereoargenteus), present but not common. The coyote (Canis latrans) is the main mammalian predator in the prairie type vegetation, feeding on rodents such as the cotton rat and plains pocket gopher (Geomys bursarius).

Rodents typical of developed areas such as Beaumont and Orange, Texas include the house mouse (Mus musculus), roof rat (Rattus rattus), and Norway rat (Rattus norvegicus). Table K.8-1, Appendix K.8 is a more complete list of the mammals characteristic of the Texoma study area, with notations on local abundance.

Birds

The vast marshlands of the Gulf Coast provide an array of habitats suitable for use by a wide variety of resident and transient species of birds. This area is especially important as a wintering area for many species of waterfowl. Common dabbling ducks of the area include the Mallard (Anas platyrhynchos), Gadwall (Anas strepera), American Wigeon (Anas americana), Green-winged Teal (Anas crecca), Blue-winged Teal (Anas discors), Shoveler (Anas clypeata), Pintail (Anas acuta), and Mottled Ducks (Anas fulvigula). The preferred habitat of these ducks is fresh marsh and rice fields, but they are generally found in all marsh types within the proposed study area. Diver ducks common to the larger water bodies of the area such as Sabine Lake include the Canvasback (Aythya valisineria), Lesser Scaup (Aythya affinis), and Red-breasted Merganser (Mergus serrator). Ducks seldom make use of the dredged material sites in these marsh areas. The Wood Duck (Aix sponsa), is the only common species of duck that has established permanent populations in the region. This duck is rarely seen in the marshes, since it prefers swamp and bottomland forests like those found in Calcasieu Parish. All common migratory ducks are winter residents. Several species of geese also utilize the area wintering grounds, with the highest populations being found on the Sabine National Wildlife Refuge. The Canadian Goose (Branta canadensis), is found mainly in rice fields and marshes, and the Snow Goose (Chen caerulescens), prefers brackish marsh, rice fields, and pastures. The other common species, the White-fronted Goose (Anser albifrons), favors rice fields. The American Coot (Fulica americana) is also common in fresh water lakes and marshes.

Other common winter residents of the marsh and lake shores include the Common Snipe (Capella gallinago), Marsh Hawk (Circus cyaneus), Gull-billed Tern (Gelochelidon nilotica), Tree Swallow (Iridoprocne bicolor), Marsh Wren (Telmatodytes palustris), and the Greater and Lesser Yellowlegs (Tringa melanoleuca and T. flavipes).

Common residents of the area include the King and Clapper Rails (Rallus elegans and R. longirostris), and Purple and Common Gallinules (Porphyryla martinica and Gallinula chloropus), with

the rail birds found along the marshes and the gallinules in shallow-fresh water ponds. All are shore birds. Other permanent residents of the marshes include numerous wading birds, including the Willet (Catoptrophorus semipalmatus), Great Blue Heron (Ardea herodias), Louisiana Heron (Hydranassa tricolor), Black-crowned Night Heron (Nycticorax nycticorax), Yellow-crowned Night Heron (Nyctanassa violacea), the Great Egret (Casmerodius albus), Snowy Egret (Egretta thula), the Least Bittern (Ixobrychus exilis), and American Bittern (Botaurus lentiginosus). Other permanent residents of the marshes include the Red-winged Blackbird (Agelaius phoeniceus), Marsh Wren (Telmatodytes palustris) and Seaside Sparrow (Ammospiza maritima).

Common inhabitants of the farmlands, old fields and other early succession habitats include the Bobwhite (Colinus virginianus), several species of doves (Columba livia and Zenaida spp.), the Killdeer (Charadrius vociferus), Crow (Corvus brachyrhynchos), European Starling (Sturnus vulgaris), and Savannah (Passerculus sandwichensis), and Field Sparrows (Spizella pusilla).

Many forest songbirds cross the study area in the spring of the year as they migrate from Mexico to their breeding grounds. During periods of bad weather, these species will temporarily reside in the scattered woodlands located on the cheniers of Jefferson County and Cameron Parish. These are the first protected areas encountered after the birds' trans-Gulf migration. After resting here a short time, many species continue their flight northward.

Forest residents in the area include the Mourning Dove (Zenaida macroura), Common Snipe (Capella gallinago), and several species of owls, woodpeckers and warblers. Bobwhite occur in open woods.

Top predators include the Red-tailed Hawk (Buteo jamaicensis), Marsh Hawk, and the American Kestrel (Falco sparverius). The Red-tailed Hawk nests in woodlands and feeds in open fields. Marsh Hawks inhabit grasslands and marshes and are common in Cameron Parish, while the American Kestrel prefers open and semi-open terrestrial sites. An important scavenger, the Turkey Vulture (Cathartes aura), utilizes fields to a major extent. Table K.8-2, Appendix K.8 is an annotated list of the birds in the Texoma study area with notations on their local abundance. The list includes marine species occurring along the Texas and Louisiana Coast as well as more inland species.

Amphibians and Reptiles

Among the common amphibians and reptiles in the study area, one of the most widespread in the flooded river bottoms, swamps and brackish to fresh marshes is the American alligator (Alligator mississippiensis). Turtles common to the study area include the common and alligator snapping turtles (Chelydra serpentina and Macrochelys temminckii), the midland smooth and pallid spiny softshell turtles (Trionyx muticus and T. spiniferus), and the Texas Diamondback Terrapin (Malaclemys terrapin). The latter species inhabits brackish and salt marshes of Jefferson County and Cameron Parish, while snapping turtles prefer freshwater rivers, swamps, lakes and ponds of Calcasieu Parish. Softshell turtles are found mainly in open waters. Mud and musk turtles (Kinosternon subrubrum and Sternotherus spp.), are mainly aquatic, inhabiting a wide variety of habitats including marshes, rivers, and lakes in the study area.

Most of the toads (Bufo spp.), in the area inhabit fields bordering on water. One exception is Hurter's spadefoot toad (Scaphiopus hurteri), which is found mainly in woodlands. The squirrel and southern gray treefrogs (Hyla squirella and H. versicolor chrysoscelis), are located in moist forested areas, along with the northern spring peeper and upland chorus frog (Pseudacris triseriata feriarum). The green treefrog (Hyla cinerea cinerea), is an exception, preferring areas with permanent bodies of standing water. Other species preferring a similar habitat include several species of salamanders, the central newt (Diemictylus viridescens louisianensis), bullfrog (Rana catesbeiana), and southern leopard frog (Rana pipiens sphenoccephala). The small-mouthed and marbled salamanders (Ambystoma texanum and Ambystoma opacum), breed in the open water and live underground in woodlands in the northern part of the Texoma area much of their lives.

Of the common lizards, the western slender glass lizard (Ophisaurus attenuatus), six-lined racerunner (Cnemidophorus sexlineatus), and the Texas horned lizard (Phrynosoma cornutum), frequent dry fields, grasslands, and dry open woods such as is found in Orange County. The eastern fence lizard (Sceloporus undulatus), similarly prefers dry sites, being especially partial to open pine woods with rotting logs and stumps. In contrast, several common species prefer wetter sites. These include the ground skink (Lygosoma laterale), an inhabitant of woodland floors, the five-lined skink (Eumeces fasciatus), which prefers damp cutover woodlands with rock piles and rotting stumps, and the broad-headed skink (Eumeces laticeps), the most

arboreal of the skinks, whose choice habitat is swamp forests where it utilizes hollow trees and holes in trees for cover. However, several of the above mentioned species also adapt to urban and residential habitats frequenting the walls and foundations of buildings as well as vacant urban lots. These include the ground skink and especially the green anole (Anolis carolinensis).

Various water snakes are found in low-lying swamps and bottomlands with permanent bodies of water nearby throughout the Texoma study area. All the poisonous species [the western cottonmouth (Agkistrodon piscivorus leucostoma), western pygmy rattlesnake (Sistrurus miliarius streckeri), canebrake rattlesnake (Crotalus horridus atricaudatus), southern copperhead (Agkistrodon contortrix contortrix, and Texas coral snake (Micrurus fulvius tenere)], are creatures of these wetter habitats, although the latter species is often in well-drained upland areas. Moist woodlands are also preferred by the Western ribbon snake (Thamnophis sauritus), and western mud snake (Farancia abacura reinwardti).

Drier woodlands areas usually are inhabited by the eastern hognose snake (Heterodon platyrhinos) and Mississippi ringneck snake (Diadophis punctatus stietogenys). Earth snakes (Haldera Spp.), are usually found in fields. The brown snake (Storeria dekayi), garter snake (Thamnophis Spp.), eastern coachwhip (Masticophis flagellum flagellum), rough green snake (Opheodrys aestivus), rat snakes (Elaphe obsoleta), and king-snakes (Lampropeltis spp.), are found in a wide variety of habitats in the area. Table K.8-3, Appendix K.8, is an annotated list of the reptiles and amphibians known to frequent the Texoma study area.

B.2.5.3 Rare or Endangered Species of the Region

B.2.5.3.1 Plants

At the present time, no plant species have been officially designated as Endangered or Threatened Species pursuant to Section 4 of the Endangered Species Act of 1973 (Public Law 93-205). Two proposed listed listings have been published in the Federal Register (U.S. Fish and Wildlife Service, 1975; 1976). The plants listed in these publications are currently being studied by the Fish and Wildlife Service for determination as Threatened or Endangered Species pursuant to procedural steps set forth in the Federal Register of June 7, 1976 (41 FR 22915-22922).

Plants listed in the earlier publication (U.S. Fish and Wildlife Service, 1975) include 3,100 vascular plants which the Smithsonian Institution has proposed as candidate species for listing as endangered, threatened or extinct (Smithsonian Institution 1975).

Plants listed in the 1976 endangered species list are those plants which the Fish and Wildlife Service has officially proposed to be Endangered Species only.

At the present time, both listings should be used as guidelines for identifying which species will potentially be designated as Endangered or Threatened pursuant to the Endangered Species Act of 1973.

Louisiana

None of the plant species which have been proposed for Endangered or Threatened status for the state of Louisiana have been cited in Calcasieu or Cameron Parishes (Robertson, 1977).

Texas

Eight species for east Texas were proposed as Endangered in the Register listing for June 16, 1976. They are:

Machaeranthera aurea
Coreopsis intermedia (tick seed)
Bartonia texana
Brazoria pulcherrima
Hibiscus basicalyx
Leavenworthia aurea
Phlox nivalis subsp. texensis
Schoenolirion texana
Spiranthes parksii

According to the records of the herbariums at the University of Texas at Austin and Southern Methodist University, Dallas, none of these eight species have been cited in Jefferson or Orange Counties (Lott, 1977).

Several species, which appeared in the July 1976 listing, have not been reported for Jefferson or Orange County's but occur in neighboring counties. Neolloydia gautii, a cactus, which is listed as Endangered (U.S. Fish and Wildlife Service, 1976), has been sited around Sour Lake, Hardin County. Phlox nivalis subsp. texensis is also listed as Endangered and has been

sited from Hardin and Polk Counties (Lott, 1977). P. nivalis is a small shrub which is found in open grassy pineland throughout east Texas.

The Rare Plant Study Center at the University of Texas at Austin has identified several species as rare and endangered in Jefferson and Orange Counties (Rare Plant Study Center, 1974). They are:

Jefferson County

Aureolaria dispersa (Beaumont Aureolaria)

Carex albolutescens (Yellow-White Sedge)

Carex gracilescens (Slender Sedge)

Carex physorhyncha (Hidalgo Sedge)

Carex tribuloides (Sand Sedge)

Carya myristicaeformis (Nutmeg Hickory)

Thelypteris palustris var. haleana (Southern Marsh Fern)

Orange County

Conyza bonariensis (Buenos Aires Conyza)

Ilex verticillata (Black alder)

Ruellia pinetorum (Pinebarren ruellia)

At the current time the Rare Plant Study Center is considering only two of these species for submission to the Office of Endangered Species, Fish and Wildlife Service. Ruellia pinetorum, a member of the Acanthus family, occurs in low pine barrens of the coastal plain. Aureolaria dispersa is found in sandy thickets and oak lands and has been known to occur along streams in the long-leaf pine belt (Pennell, 1935).

B.2.5.3.2 Animals

Within the Texoma study area there are two terrestrial and four marine mammals, eight birds, and four reptiles which are classified as either endangered or threatened, as defined by the Endangered Species Act of 1973.

One of the two endangered terrestrial mammals, the gray wolf (Canis lupus), is occasionally encountered in the Trans-Pecos region of west Texas and is only of historical interest in southeast Texas. The other endangered terrestrial mammal, the red wolf (Canis ruffus), is now restricted to the Gulf Coast counties and is now on the verge of extinction. There are currently less than 100 red wolves left in Jefferson, Chambers, and southern Liberty Counties in Texas and Cameron and Calcasieu Parishes in Louisiana. The U. S. Fish and Wildlife Service is currently trapping wolves in this area in order to breed and later introduce individuals to areas outside Texas and Louisiana (Wagner, 1976). They are not being re-introduced back into these states because cross-breeding with coyotes in the area is eradicating the wolf as a pure species. In addition, human disturbance in coastal areas is reducing the amount of suitable habitat currently available to the animals.

There are four endangered marine mammals in the study area, the blue whale (Balaenoptera musculus), the common finback whale (Balaenoptera physalus), the black right whale (Eubalaena galcialis), and the sperm whale (Physeter catodon). Records of the occurrence of these species are sparse as indicated below (Davis, 1974):

blue whale:	Rare along the Texas Coast with two records of single individuals stranded onshore in the 1930's.
common finback whale:	Rare along Texas Coast - One record of a young individual stranded onshore in 1951.
black right whale:	Usually found in open oceans. One record of a single specimen beached in 1972.
sperm whale:	Mostly tropical in distribution - One record of an old individual beached near Sabine in 1910.

Birds on the federal list of endangered species in the area are the Brown Pelican (Pelecanus erythrorhynchos), Bald Eagle

(Haliaeetus leucocephalus), Peregrine Falcon (Falco peregrinus), Atwater's Greater Prairie Chicken (Tympanuchus cupido), Whopping Crane (Grus americana), Red-cocked Woodpecker (Dendrocopus borealis), and Ivory-billed Woodpecker (Campephilus principalis). In the 1950's and 1960's the Brown Pelican population declined dramatically and is only now slowly recovering. The decline was due to a combination of factors, the most important of which was an increase in chlorinated hydrocarbons in the food chain. This same decline in numbers has been observed in the past with the Bald Eagle; with chemical contaminants also being responsible for much of the decline. An official of the U. S. Fish and Wildlife Service states that the Bald Eagle has been sighted on numerous occasions along the Sabine River, south of Orange, Texas (Aycock, 1976). These birds are mostly immature individuals and no official sightings of nesting birds have been recorded for the area. The last confirmed nests of this species along the Sabine River were sighted in the early 1950's.

The Whopping Crane, Ivory-billed Woodpecker, and Atwater's Greater Prairie Chicken are important in the Texoma study area primarily from a historical viewpoint. The last Whopping Crane seen in Louisiana were in 1949, while the last Ivory-bill was recorded in 1943 (Lowery, 1974). The Prairie Chicken, last recorded in the area in 1919, is now found only on the coastal plains of the central Gulf Coast of Texas (Oberholser, 1974).

The Peregrine Falcon and Red-cockaded Woodpecker are very infrequent visitors to the study area. The woodpecker, for example, is known to nest in isolated groups in mature pine forest, however, none of these birds have been found to be within the Texoma area.

Information on uncommon sightings of birds in the coastal marsh areas was provided by an official of the National Audubon Society (Read, 1976). These sightings include records of the Great Kiskadee (Pitangus sulphuratus), and White-winged Dove (Zenaida asiatica), species which are more common in Mexico. The Black Francolon (Francoelinus francolinus), a pheasant-like bird, has also been sighted in the area. It is not native to the U. S., but has established a breeding population in the higher ground in Gum Cover, 5 miles northeast of Black Bayou. Another bird, Audubon's Caracara (Caracara cheriwan), has been observed for a

number of years in the vicinity of the Intracoastal Waterway south of Toomey, Louisiana. Indications are that there are a pair of Caracara and they would represent the northernmost occurrence of this species in the U.S. as permanent residents. The waterways in this area have also become a desirable habitat for the Fish Crow (Corvus ossifragus), and Olivaceous Cormorant (Phalacrocorax olivaceus). They are very abundant around Sabine River and Sabine Lake all winter and are uncommon for many miles to the east and west.

The six reptiles on the federal list of endangered species are the Hawksbill turtle (Eretmochelys imbricata), Atlantic ridley turtle (Lepidochelys kempi), Leatherback turtle (Dermodochelys coriacea), Atlantic green turtle (Chelonia mydas), Atlantic loggerhead turtle (Caretta caretta), and the American alligator (Alligator mississippiensis). Nationwide, the populations of the Atlantic green turtle and the Atlantic loggerhead are not threatened with extinction, but because of a "similarity of appearance" to other endangered species of turtles, the green turtle and loggerhead have been classified as "endangered." This was done in order to keep individuals of truly "endangered" species from being inadvertently killed because they looked like another species which could, in the past, be killed legally for food. All of the turtles on the federal list are marine and uncommon off the coast of Jefferson County and Cameron Parish.

The status of the American alligator is unique in Cameron, Vermilion, and Calcasieu Parishes in Louisiana. In other areas of the United States, the alligator is either classified as threatened or endangered, but because of its abundance in the abovementioned parishes, they are not given protection under the Endangered Species Act. In addition, the status of the alligator in Texas has recently been changed from "endangered" to the less restrictive "threatened" classification.

B.2.5.4 Important Commercial Species of the Region

B.2.5.4.1 Plants

Agriculture is carried out on a relatively small scale in western Cameron Parish although it is a prominent source of income in relation to the number of inhabitants. Quantities of the principal crops in the parish, rice, soybeans, and corn, are presented in Table B.2-8 . The values in Table B.2-8 are considerably greater than the production in western Cameron Parish since the large eastern part of the parish, which contains much of the arable land, is included. Some hay (U.S. Bureau of the Census, 1970) is also grown in the parish. Most of western Cameron Parish is marshland. No commercial timber is harvested. The marsh vegetation has economic, although not commercial, importance.

Four of the thirteen agricultural regions of Louisiana are included within Calcasieu Parish; however, only three of these are in the western part (Newton, 1972). These are the longleaf pine flats (to the north), the sea marsh (to the south), and the gray silt prairie (between the other two regions). The principal cash crops (Table B.2-8) in Calcasieu Parish are rice, soybeans, and corn. Minor amounts of wheat, sorgham, and hay also are produced. Much of the agricultural production is in the eastern part of the parish where calcareous prairie soils are present. There is some timber production in Calcasieu Parish, with pine saw timber constituting the lion's share. In 1970-71 a survey by the Louisiana Forestry Commission indicated that tree plantations in the parish covered 33,387 acres (Bobo and Charlton, 1974). Forest statistics for Calcasieu Parish are presented in Table B.2-9 .

Table B.2-8 Principal Cash Crops in Cameron and Calcasieu Parishes

	Cameron Parish		Calcasieu Parish	
	Quantity	Area	Quantity	Area
Rice	480,000,000 lbs	12,550 acres	2,257,900,000 lbs	67,400 acres
Soybeans	280,000 bu	10,000 acres	875,000 bu	35,000 acres
Corn	2,700 bu	100 acres	7,000 bu	200 acres

B.2-91

Source: Louisiana State University Agricultural Experiment Station, 1976,
Louisiana crop statistics, by parishes: D.A.E. Research Report No. 436.

Table B.2-9 Timber Severed in Calcasieu Parish
in 1970

	Pulpwood (board feet)	Saw Timber (board feet)
Cypress		9,457
Oak		1,057,901
Ash		354
Pine	41,494	5,094,833
Gum		612,420
Unspecified Hardwoods	2,507	1,213,519

Source: Bobo, J.R. and Charlton, J.M., Jr. (eds.), 1974,
Statistical abstract of Louisiana: College of
Business Administration, University of New Orleans,
New Orleans, Louisiana.

Most of the extensive rice production within the Texas part of the Texoma region is found in Jefferson County, to the southwest of Orange County. Locally, small former prairie areas within the woodland timber belt, which occurs from approximately the town of Orange northward, are cultivated in various crops including rice. Such areas are also used as rangeland and pasture. Hay and grain crops are used mainly in support of beef production. Timber is a natural product in the country. However, the main use for timber and woodlands is as wildlife habitat (Fisher, et al., 1973).

Some 49.5 square miles of Orange County are devoted to agriculture. This figure includes cropland, orchards, forest nurseries, silage crops for grazing, and significant acreage presently out of cultivation but in rotation or likely to be used for crops in the future based on previous use. Rice (Oryza sativa) was grown on approximately 2,777 acres in the county in 1970. The average U. S. yield per acre was 4,381 pounds in 1969 (USDA, 1973).

The commercial timber in Orange County is mainly mixed pines and bottomland hardwoods. The commercial growing stock is estimated at 65.1 million cubic feet of pine softwoods, 38.6 million cubic feet of pine hardwoods, 23.3 million cubic feet of deciduous bottomland hardwoods, and 8.9 million cubic feet of deciduous bottomland softwoods (Earles, 1976). The forest industry owns more than half of this timber, and the rest is under miscellaneous private ownership. The principal forest types and their estimated acreages are: oak-hickory (34,800 acres), oak-gum-cypress (34,800 acres), oak-pine (29,000 acres), loblolly-shortleaf pine (23,200 acres), and longleaf-slash pine (11,600 acres).

The commercially important plants found within Jefferson County can be divided into two categories. The first group includes the species which are of direct economic significance; those which are gathered or harvested for food products or industrial use. The second group includes plants of secondary importance; those that provide food and shelter for commercially important animals species of the region.

Figures for farmland production and income for Jefferson County are listed in Table B.2-10. These figures include harvested crop; rice, hay and soybeans; and pastureland, upon which beef cattle graze.

Table B.2.10 Farmland - Jefferson County Texas¹

	<u>Acres</u> ¹	<u>Income 1976</u> ³
<u>Total Farmland</u> ²		
(includes farm buildings)	328,726	\$23,292,000
 <u>Cropland</u>		
(includes fallow land and pastureland)	150,955	
 <u>Harvested Cropland</u>	89,602	
Rice	79,994	18,000,000
Hay	4,335	
Soybeans	3,900	800,000
 <u>Pastureland</u>	36,841	2,000,000 (beef cattle)
 <u>Other</u> (fallow fields, etc.)	24,512	

(1) All figures for 1974

(2) Source: Bureau of Census, Department of Commerce, 1974, Census of Agriculture Preliminary Report for Jefferson County, Texas.

(3) Weaver, E. M., 1977, personal communication, County Agricultural Agent Jefferson County, Texas.

Rice and other crops have been planted on what was originally prairie grasslands (see Section B.2.5.2.4). The rice is planted on terraces which are flooded during the growing season. Because of the high water holding capacity of prairie grassland soil, the area has excellent rice production harvests.

Pasture land has been discussed in Section B.2.5.2.4. Land that was originally prairie grassland has been planted with commercial grasses for grazing purposes. These planted species include ryegrass, alyceclover, white clover, and dallisgrass.

The primary use of marshlands is for cattle grazing. Although productivity is low (as low as one steer per 20 acres), farmers turn cattle out to graze on the natural vegetation of the fresh and brackish water marshes.

Timber is another source of income for the people of Jefferson County. Although the amount of commercial forest land* decreased by 4 percent in east Texas between 1965 and 1975 (Earles, 1976), the growing stock volume** of all species increased by 12 percent. Figures for timber production for Jefferson County are listed in Table B.2-11.

Softwood trees include longleaf, slash, shortleaf, and loblolly pine and totaled 384,000 cords in 1975. The majority of these trees were harvested from the mixed pine and hardwood forest association of upland Jefferson County (see Section B.2.5.2.4). Principal hardwoods which were harvested for commercial purposes were oaks (269,000 cords) and sweetgum (287 cords) (Earles, 1976). These trees were harvested from the swamp and fluvial woodland associations of central Jefferson County.

*Commercial forest land - Forest land producing or capable of producing crops of industrial wood and not withdrawn from timber utilization.

**Growing stock volume - Net volume in cubic feet of growing stock trees at least 5.0 inches in diameter at breast height, from a 1-foot stump to a minimum 4.0-inch top diameter outside bark of the central stem, or to the point where the central stem breaks into limbs.

Table B.2-11 Commercial Timber Production,
Jefferson County, Texas 1975

	<u>Acres</u>
<u>Total Commercial Forest</u>	50,400
 <u>Forest Type</u>	
Loblolly - Shortleaf Pine	6,300
Oak - Pine	6,300
Oak - Hickory	6,300
Oak - Gum - Cypress	31,500
 <u>Physiographic Site</u>	
Pine	18,900
Bottomland - Hardwood	31,500

Source: Earles, J. M., 1976, Forest Statistics for Southeast Texas Counties, U.S. Dept. of Agriculture Forest Service Resource Bulletin 50--58: Forest Service, U.S. Dept. of Agriculture.

The marsh vegetation of coastal southeast Texas and Louisiana provide a valuable source of detritus which is the basis for the highly productive food web of the coastal zone. Many marine organisms are dependent, for at least part of their life cycle, on this food source. The annual primary productivity of the marsh system of Jefferson County is therefore of value to the finfish and shellfish industries of the Gulf Coast region.

B.2.5.4.2 Animals

Some cattle production is based in western Cameron Parish. This is restricted to near the coast and the fingers of former prairie which extend into the western part of the parish from the north.

Other important animals, however, are furbearing animals which live in the marshes, and estuarine and marine fish and invertebrates. The nutria, muskrat, mink, otter, and raccoon; are sources of the fur industry in Louisiana. Fresh and intermediate marsh types are more valuable for nutria harvest, while brackish vegetative types are important for muskrat production. In 1975 and 1976, there were limited (state controlled) harvests of the American alligator for its hide in parts of Cameron, Calcasieu, and Vermilion Parishes.

The Sabine National Wildlife Refuge is located within the study area, and is divided into three lease areas for trapping: Back Ridge, Gate Camp, and West Cove. Table B.2-12 is a breakdown of harvest for each of these areas. These data should be indicative of the marshlands within the study area due to the enormous size of the refuge.

The Louisiana Coastal zone is an exceedingly productive fisheries and wildlife resource, as it contains an extensive amount of estuarine habitat. Louisiana leads all states in volume of catch of commercial fisheries products. The lakes and bayous of western Cameron Parish, especially Calcasieu Lake, are extremely important as a nursery area.

As shown in Table B.2-13, the most important commercial species in western Cameron Parish, as well as throughout Louisiana, are menhaden (Brevoortia spp.), shrimp, and Atlantic Croaker (Micropogon undulatus). However, the croaker has declined in western Louisiana in recent years (Allen, 1975a, 1975b, 1976).

Table B.2-12 Furbearer Harvest in Sabine National Wildlife Refuge

	<u>Muskrat</u>				<u>Value</u> for 1975-1976 <u>Harvest (dollars)</u>
	1972-1973	1973-1974	1974-1975	1975-1976	
Back Ridge	391	51	84	202	844.80
Gate Camp	0	0	0	16	67.00
West Cove	159	18	23	33	131.75
	<u>Mink</u>				
Back Ridge	40	69	33	18	88.50
Gate Camp	2	2	5	25	128.90
West Cove	50	28	21	14	56.80
	<u>Otter</u>				
Back Ridge	6	6	6	5	103.10
Gate Camp	4	1	4	2	36.00
West Cove	4	5	4	3	68.50
	<u>Nutria</u>				
Back Ridge	4,915	3,400	2,767	2,489	11,116.00
Gate Camp	1,347	693	597	1,068	4,805.76
West Cove	2,946	1,886	2,013	1,073	4,756.00
	<u>Raccoon</u>				
Back Ridge	88	107	118	44	164.00
Gate Camp	0	33	53	40	149.90
West Cove	99	90	51	89	376.25

Table B.2-13 Average annual harvest and value of major commercial fishes and shellfish for Louisiana during period 1963-67.

Species	Eastern Cameron Parish	Western Cameron Parish	Louisiana
Menhaden			
Production 1	12.40	41.10	713.06
Value 2	0.18	0.58	10.12
Shrimp			
Production	0.50	2.90	73.51
Value	0.19	1.05	26.68
Croaker			
Production	0.30	2.11	23.71
Value	0.01	0.04	0.42
Oyster			
Production	0.00	0.29	9.97
Value	0.00	0.13	4.39
Blue Crab			
Production	0.04	0.62	8.27
Value	0.004	0.05	0.73
Spot			
Production	0.11	0.53	4.62
Value	0.002	0.01	0.08
Catfish and Bullheads			
Production	0.22	0.003	4.59
Value	0.04	0.001	0.78
Seatrout			
Production	0.08	0.42	4.11
Value	0.003	0.02	0.19
Red Drum			
Production	0.00	0.02	0.53
Value	0.00	0.003	0.09
Total			
Production 1	13.65	47.99	842.37
Value 2	0.43	1.88	43.48
Estuarine water 3	13	134	3,283
Production, pounds/acre	1,050.0	358.1	256.6
Value dollars/acre	33.1	14.0	13.2

1 Millions of pounds

2 Millions of dollars

3 Thousands of acres

Source: Lindall et.al., 1972

The most important seafood categories in Cameron Parish as of 1975, are menhaden, shrimp, blue crabs, spotted sea trout, red drum, flounder, red snapper, and catfish. Weights and dollar values for these and other categories are given in Table B.2-14. White and brown shrimp (Penaeus setiferus and P. aztecus) production within Cameron Parish is extensive. During peak harvest periods as much as 100,000 pounds have been collected in a single night (White, 1976). Calcasieu Lake contains the major shrimp fishing grounds of western Louisiana, with over 1,000 vessels fishing daily during the inside spring shrimp season (Gaidry and White, 1973). Many of the brown shrimp in Calcasieu Lake are larger juveniles which may have migrated from nursery areas in Rockefeller Wildlife Refuge to the east. Calcasieu Lake is a final staging area before return migration to the Gulf, maturation, and spawning. Black Lake is reported rich in shrimp and fish (White and Rocca, 1976).

Most (97.5 percent) of the commercial fish catch of the Gulf states is made up of estuarine dependent species. In most cases, this means the estuary is a maturation area into which they come as eggs or larvae, and leave as subadults or adults (Dunham, 1972). The estuaries of the Gulf have been estimated to produce an average of 230 pounds per acre in commercial catches of fish and shellfish (estimated for 1960) (Dunham, 1972).

Oyster production in Calcasieu Lake was historically good. Water conditions are more conducive to oyster productivity in the southwestern part of the lake. The productivity of the northern and eastern portions of the lake has declined in recent years, possibly from an altered circulation pattern as a result of channel levees created from the disposal of dredged material. In an effort to re-establish oyster population in these areas, the Corps of Engineers and the Louisiana Wildlife and Fisheries Commission have modified the levees and worked to improve the oyster habitat within the region. These efforts were reported to have met with moderate success (White and Perret, 1974). The commercial catch for Cameron Parish in 1971 was 438 million pounds valued at \$11.0 million, while in 1973 the catch was 339 million pounds valued at \$19.2 million. However, there has been no commercial harvest taken from western Louisiana since 1973 based on examination of Louisiana landing annual statistics (Allen, 1975a, 1975b, 1976).

Table B.2-14 Landings for Cameron and Calcasieu Parish*

	1973		1974		1975	
	Pounds	Value (Dollars)	Pounds	Value (Dollars)	Pounds	Value (Dollars)
Buffalo fish	900	123	9,800	1,369	-	-
Carp	-	-	200	3	-	-
Catfish F.W.	16,500	4,502	49,100	14,408	4,000	1,456
Carfish	500	49	2,200	314	400	82
Caspeygou	100	21	1,400	221	-	-
Black Drum	100	6	-	-	2,600	417
Red Drum	1,900	668	1,600	499	22,300	6,314
Flounder	20,600	4,842	200	72	15,400	5,159
King Whiting	1,100	168	-	-	-	-
Menhaden	329,575,100	13,532,472	398,195,800	14,785,206	387,117,400	11,564,331
Sea Catfish	600	62	-	-	-	-
Spotted Sea Trout	287,000	116,103	108,500	36,049	253,600	97,444
White Trout	400	57	-	-	-	-
Sheepshead	400	57	-	-	700	66
Red Snapper	13,700	4,084	700	393	7,900	4,167
Crab, Hard	157,900	17,550	327,300	48,598	2,124,100	329,083
Shrimp, S.W.	6,602,100	5,490,794	6,625,000	4,029,220	5,217,800	4,242,938
Oyster	31,400	17,827	-	-	-	-

*The contribution from Calcasieu Parish is minimal.

Source: Plaisance, O.A., National Marine Fisheries Service, NOAA,
New Orleans, Louisiana.

Table B.2-15 presents a detailed breakdown of the commercial fishery resources in Louisiana inshore and offshore waters, as well as in Calcasieu Lake. It is evident that the shellfish harvest (pounds) far exceeds the finfish harvest for Calcasieu Lake, while the opposite is true for offshore and other inshore waters.

The most important commercial wildlife species of Calcasieu Parish are the furbearers: nutria, muskrat, mink, otter, and raccoon. Almost all the trapping is confined to the swamp and marsh areas near waterways.

The coastal marsh trapper is truly a commercial operator. Trapping leases average 100 - 300 acres in size, with the trapper running 150 - 400 traps for nutria depending on marsh conditions. Whole families are involved in the trapping operation, which sometimes constitute the main income of the family. Generally, though, the number of people involved in trapping has decreased. There were 20,149 licensed trappers in the 1924-25 season compared with 4,327 trappers recorded each year since 1970 (O'Neil and Linscombe, no date).

Approximately 37 square miles of Orange County is rated as predominately range and pasture land (Fisher, et al., 1973), although, some cattle are also present in the estimated 184 square miles of predominately woodland timber and 20 square miles of swamp timber. At 1 to 1½ cow-calf units* per acre estimated beef production (Knox and Oakes, 1976), the total for 27 square miles is 23,800 to 35,520 cow-calf units.

Commercial trapping of furbearers and harvest of fish and shellfish are very low compared to the level of these activities in Jefferson County or Cameron Parish.

The brackish and fresh water marshes along coastal east Texas support large populations of furbearing animals, many of which are commercially important. These include the nutria, mink, and muskrat. Muskrats feed primarily on the olney and saltmarsh bulrushes found in salt and brackish water marshes.

* A cow-calf unit is a brood cow and her calf.

Table B.2-15 Average annual fisheries harvest from Louisiana coastal waters, (1966-1970)

	Calcasieu Lake	Inshore Waters	Offshore Waters	Offshore- Inshore	TOTALS lbs
	lbs	lbs	lbs		lbs
Amberjack			14,466		14,466
Bluefish		2,867	8,033		10,900
Bluerunner		100			100
Buffalo		51,600			51,600
Cobia			8,167		8,169
Carp		2,533			2,533
Catfish & Bullheads		959,601			959,601
Croaker		110,400	1,716,767		1,827,167
Drum, Black	533	405,732	75,100		480,832
Drum, Red	3,433	726,566	136,167		862,733
Flounders	12,567	84,832	433,233		518,065
Gar	1,633	362,662			362,662
Groupers			263,133		362,133
Jewfish			5,666		5,666
King Whiting (Kingfish)		93,432	554,800		648,232
Menhaden		130,540,533	797,457,067		927,997,600
Mullet		116,766	10,567		127,333
Pompano		200	32,900		33,100
Sawfish		800	1,467		2,267
Scup			16,201		16,201
Sea Catfish		36,401	100,933		137,334
Seatrout, Spotted	1,034	793,735	122,166		915,901
Seatrout, Sand		90,632	271,166		361,798
Sharks		433	3,801		4,234
Sheepshead, Freshwater (FW Drum)		21,833			21,833
Sheepshead		240,064	74,366		314,430
Snapper, Mangrove			3,200		3,200
Snapper, Red		533	2,914,933		2,915,466
Snapper, Vermilion			36,566		36,566
Snapper, Yellowtail			67		67
Spanish Mackerel		3,733	54,866		58,599
Spot		4,233	23,566		27,799
Swordfish			6,067		6,067
Triggerfish			6,599		6,599
Tripletail		433	5,400		5,833
Warsaw			35,734		35,734
Unclassified Food Fish			8,366		8,366
Unclassified Industrial Fish			37,742,433		37,742,433
Total Finfish	19,200	134,650,654	842,143,965		976,794,619
Crabs	577,866	9,802,930	360,231		10,163,161
Crawfish			66,666		66,666
Shrimp	1,361,567	41,359,330	46,732,765		88,092,095
Oysters	41,667	10,856,462			10,856,462
Total Shellfish	1,981,100	62,018,722	47,159,662		109,178,384
Squid			1,998		1,998
Terrapin		800	33		833
Turtles, Baby		133			133
Turtles, Green			1,465		1,465
Turtles, Snapper		767			767
Total, Non-Finfish	1,981,100	62,020,422	47,163,158		109,183,580
Total, Harvest	2,000,300	196,671,076	889,307,123		1,085,978,199

Source: U. S. Army Corps of Engineers, Lower Mississippi Valley Division, 1973

Hunting of duck and geese in the marsh lands of Jefferson County in winter provides income to the county through hunting lease sales and associated hunting expenditures. Many species of geese and ducks are included in the millions of waterfowl which winter in Jefferson County from October through March (Soil Survey, 1965). Ducks feed on olney and saltmarsh bulrushes and intensively in ricefields. Farmers estimate that 1 to 3 barrels of rice per acre are lost to the waterfowl. In addition to domestic rice, ducks also feed on troublesome plants which invade rice fields (jungle-rice, barnyard grass, red rice). In this way, they are economically beneficial to the farming community.

Geese winter in the marsh areas where they graze on roots, tubers, and sprouts.

The white-tailed deer (Odocoileus virginianus), the most important Texas game animal, has been successfully transplanted to eastern Texas and could be a valuable commercial species in Jefferson County in the future.

Estuarine waters, river mouths, and passes along the Gulf Coast provide excellent nurseries for juvenile shrimp and fish. Jefferson County has a very large estuary system which includes Sabine Lake, the Gulf Intracoastal Waterway, and the Neches River, yet none of the major Gulf commercial fishing centers are located in this county. The Sabine District, however, which includes Jefferson County, had a total commercial catch of over 1.5 million pounds for the period January-August 1976 (NOAA, 1976).

Commercial fishing is a multimillion dollar business along the Texas coast. Landings for 1971 totaled 167.1 million pounds for a value of 69.8 million dollars. The 1972 landings were smaller at 115.2 million pounds, but are still impressive on a national basis. Table B.2-16 presents data on finfish and shellfish landings for Jefferson County from 1973-1975 (Farley, 1977).

The major commercial species on the Texas Gulf Coast are shrimp, oyster, menhaden, blue crab, and several common sport fish. The bays and estuaries are biologically very important areas since the marshes serve as the nursery grounds for most of the commercially important species on the Texas coast. In almost all cases, specimens collected from marsh

Table B.2-16 Finfish and Shellfish Landings for Jefferson County from 1973-1975

SPECIES	1973		1974		1975	
	<u>POUNDS</u>	<u>DOLLARS</u>	<u>POUNDS</u>	<u>DOLLARS</u>	<u>POUNDS</u>	<u>DOLLARS</u>
Croaker					2,300	225
Black drum	6,000	793			9,600	1,521
Red drum	10,700	3,854			12,400	4,349
Flounders	16,800	5,806	22,900	7,088	16,100	6,181
Groupers	8,600	1,222			2,700	395
King whiting	9,000	926	12,900	1,214	11,400	1,402
Sea catfish					500	53
Spotted sea trout	19,000	6,461			15,400	6,028
White sea trout	600	90				
Saltwater sheepshead	9,700	1,119	14,200	1,618	7,800	1,112
Red snapper	89,000				23,000	14,352
Uncl for food					900	88
Hard crabs	1,451,200	167,387	560,800	77,090	622,300	96,906
Shrimp	4,192,600	3,305,765	3,906,700	2,521,389	2,771,300	2,267,436

B.2-105

Source: Farley, O. H. (Supervisory Fishery Reporting Specialist, NOAA), 1977, Personal communication.

areas were juveniles. These immature and juvenile stages are more susceptible to mortality than their adult forms. Mortality can be caused by a variety of reasons, including changes in salinity or temperature, or increases in pollutants. Brief life history descriptions are included for the major commercial species of Jefferson County.

Members of the croaker family (including the sea trout, drum, and Atlantic croaker) are the most numerous fishes collected in Texas coastal waters. These migrant species move into the saline waters of the Gulf from October through December (Figure B.2-22). Most fishes then return to the bays from February to April (Gunter, 1976). In the Sabine District, approximately 5,000 pounds of croaker-type fish were caught for the period January-August 1976. The dollar value of this catch exceeds \$100,000 NOAA, 1976). Other important commercial fishes whose migratory behavior brings the young into estuarine waters include menhaden (Brevoortia spp.) and Mullet (Mugil spp.).

Shrimp are the single most valuable marine product in Texas. Shrimp landings in the state amounted to 92 percent of the total dollar value of finfish and shellfish in 1970 and 1971 (Boykin, 1972). From 1966 to 1971, Texas landings have accounted to 37 percent of the Gulf state shrimp catches. Brown shrimp are the most abundant shrimp in Texas waters and tend to be concentrated in the intermediate zone from Galveston to Rio Grande (Figure B.2-23). White shrimp are relatively more abundant in the coastal area of Jefferson County (Figure B.2-24). Pink shrimp are also caught commercially in this region. In the Sabine District, the total shrimp catch was over 1.1 million pounds for the period January-August 1976. White shrimp made up approximately 80 percent of the catch (NOAA, 1976).

Figure B.2-25 depicts the life cycles of all three shrimps in Texas waters. As with the finfishes, spawning occurs offshore, and the larvae must migrate through the passes into the estuarine nursery grounds. Again, the time at which migration occurs is important. This may vary daily. Wickham and Minkler (1975) have demonstrated considerable daily variations in locomotory behavior for penaeid shrimp change accordingly.

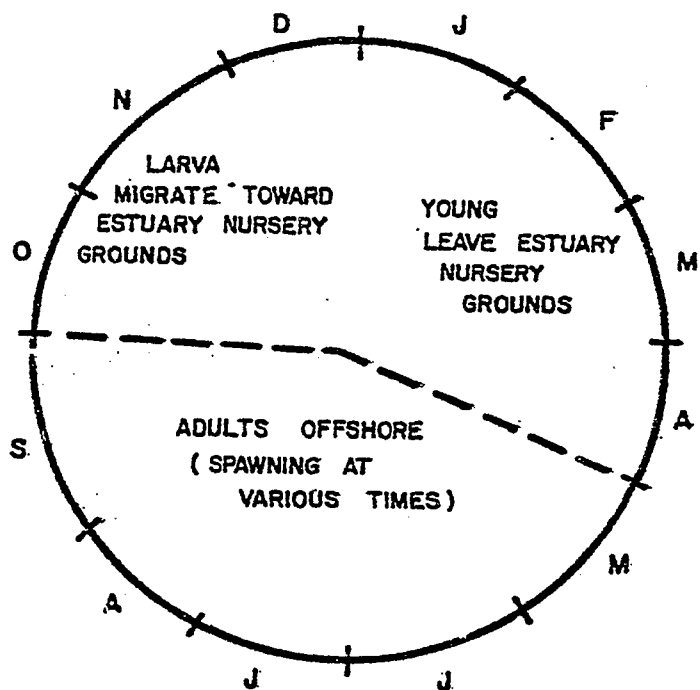

SOURCE: Smith, A. L., 1971, Autecological Study of the Marsh Grass (*Scolochloa festucacea*), Willie Link, Ph.D. Dissertation, Department Range Science, Texas A&M University, College Station, Texas.

Figure B.2-22 Idealized Life Cycle Diagram of Typical Gulf Fishes

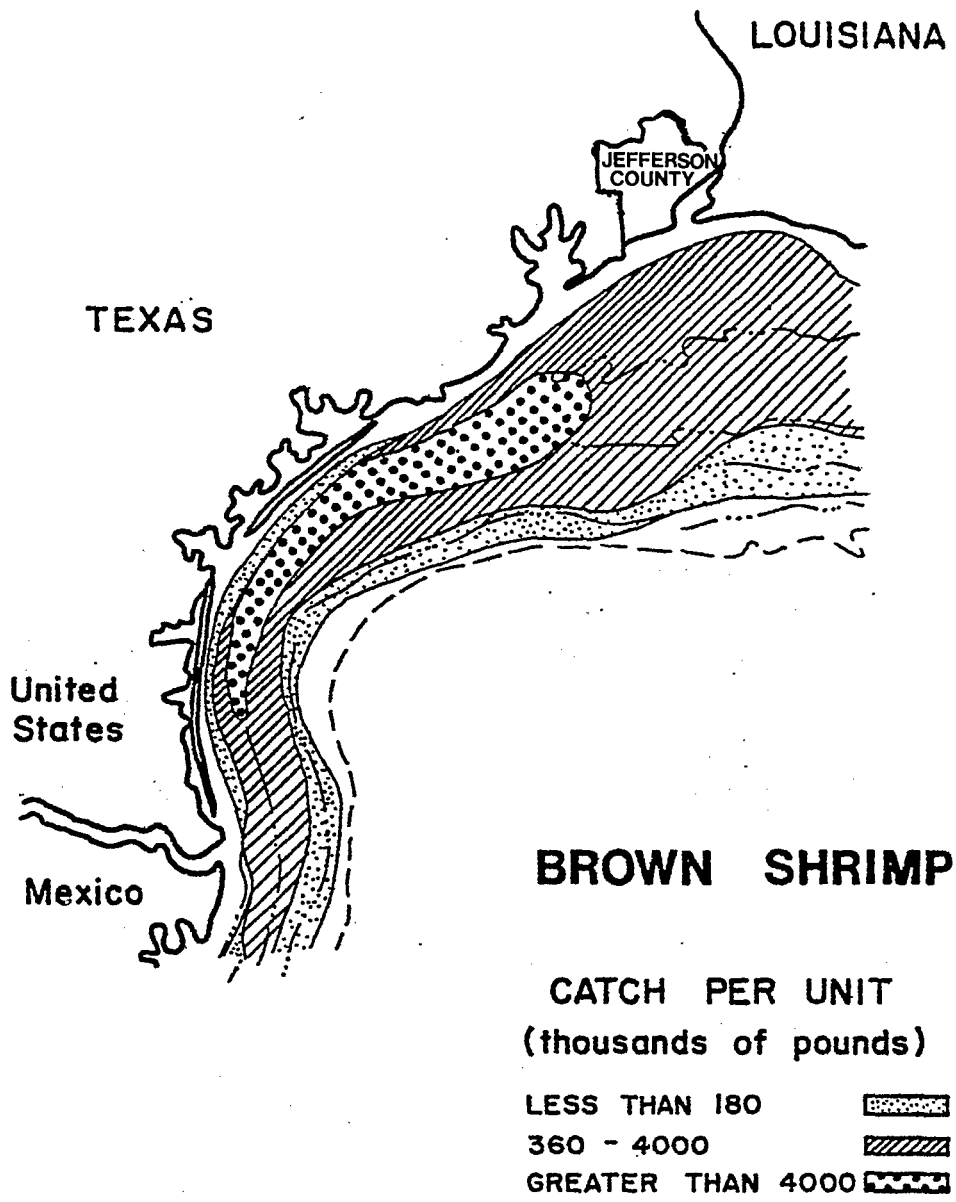

Source: Osborn, K. W., B. W. Maghan, and Shelby B. Drummond, 1969. Gulf of Mexico Shrimp Atlas. Bureau of Commercial Fisheries, Dept. of Commerce.

Figure B.2-23 Location of Brown Shrimp Grounds off the Texas Coast

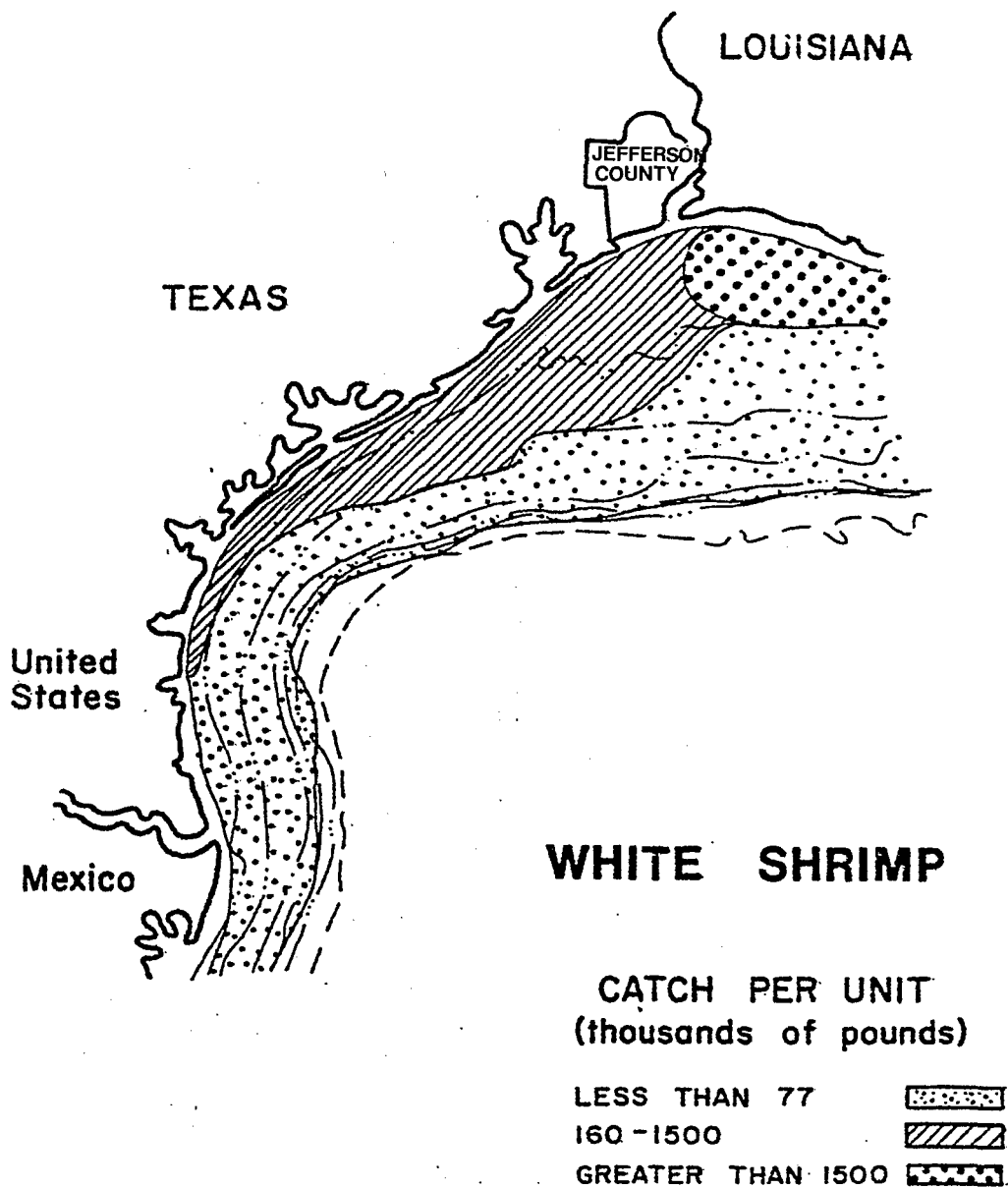

Source: Osborn, K. W., B. W. Maghan, and Shelby B. Drummond, 1969. Gulf of Mexico Shrimp Atlas. Bureau of Commercial Fisheries, Dept. of Commerce.

Figure B.2-24 Location of White Shrimp Grounds off the Texas Coast

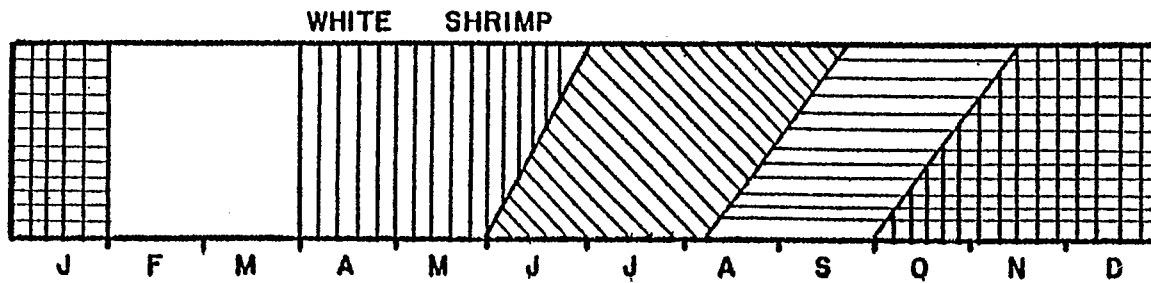

LEGEND

 SPAWN OFFSHORE
 WHITE 30'-120'
 BROWN 90'-240'
 PINK 90'-150'

 ON NURSEY GROUNDS
 IN ESTUARIES

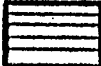
 LEAVE NURSEY GROUNDS
 FOR OFFSHORE

 LARGEST CATCH OCCUR
 OFFSHORE

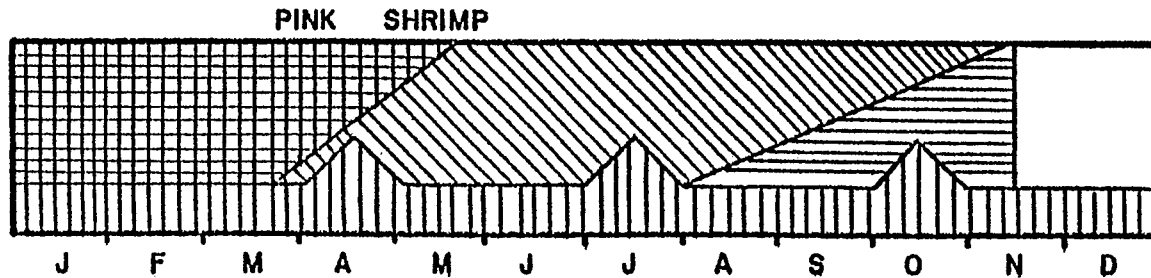
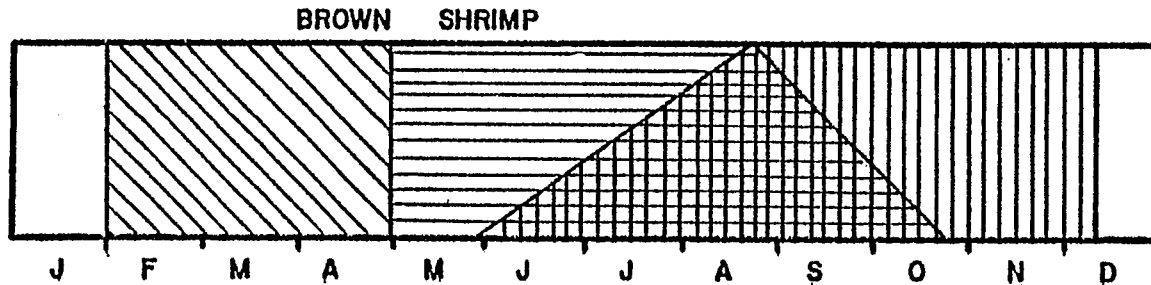

SOURCE : BOYKIN, 1971

SOURCE: Boykin, R. E., 1972. Texas and the Gulf of Mexico. Department of Marine Resources Information, Center for Marine Resources, Texas A&M University, College Station, Texas, September.

B.2-110

Figure B.2-25 The Life Cycles of Three Panaeid Shrimp in Texas Gulf Waters

Although many species of crabs are present in Texas coastal waters, the blue crab (Callinectes sapidus) is the only crab extensively exploited by man. In contrast to the shrimp, adult blue crab populations are harvested in near shore bays as well as on the inner shelf of open Gulf waters. Distribution of total crab catch in Texas in 1971 is shown in Figure B.2-26. Sabine Lake and similar bay systems are responsible for 70% of the total Gulf blue crab catch. The Sabine District alone was responsible for approximately 360 thousand pounds of blue crabs, valued at 2.1 million dollars for the period January-August 1976 (NOAA, 1976).

Darnell (1959), Dougherty (1952), Gunter (1950), and Hildebrand (1954) are primarily responsible for investigating and documenting the life history of the blue crab on the Texas coast. Generally, the life span varies from two to three years. Females may spawn more than once, producing from one to three million eggs per spawning. Fertilization of the eggs takes place in the passes and estuaries. After mating, the female carries the eggs to deeper, more saline Gulf waters for deposition. Adult males remain in the landward waters, where they may mate with maturing females. During exceptionally dry years, many of the fertilized females may remain in the more saline estuaries and lagoons. The eggs develop and hatch in about 15 days in the Gulf waters. After hatching, larval crabs called "zoeae" migrate via the currents through the coastal passes to the estuaries and lagoons, where they feed and grow to maturity. During the second summer, at the age of 12 to 14 months, the crabs mature and mate. Critical survival periods occur during the inland migration of the larva in the winter and spring.

The American oyster (Crassostrea virginica) occurs in estuaries with salinities ranges from 10 to 30 ppt. The commercial harvest distribution is centered around Galveston Bay, Sabine Lake, and Trinity Bays (see Figure B.2-27). Oyster catches have declined over the last three years from 4.6 million pounds to less than 4.0 million in 1972.

Maturation of gonads in the oyster occurs in the early spring, usually February and March. As the gonads enlarge and develop, the oyster assumes a "milky" appearance. As the water temperatures reach 24°C (75°F), usually from April to October, spawning is triggered. Spawning by one oyster stimulates others to spawn. Therefore, the majority of oysters on an area may be spawning at the same time. The sperm and eggs are expelled out into the water, where fertilization occurs. After fertilization, the eggs undergo division and many-celled embryos, capable of free swimming, are formed. A "shell" begins forming and the miniature oyster larvae, known as a "spat", settles to the bottom in search of clean, firm substrate on which to cement itself. Unless a suitable attachment site is found, the spat will die. One attached, it remains for life. As adults, oysters get fat in

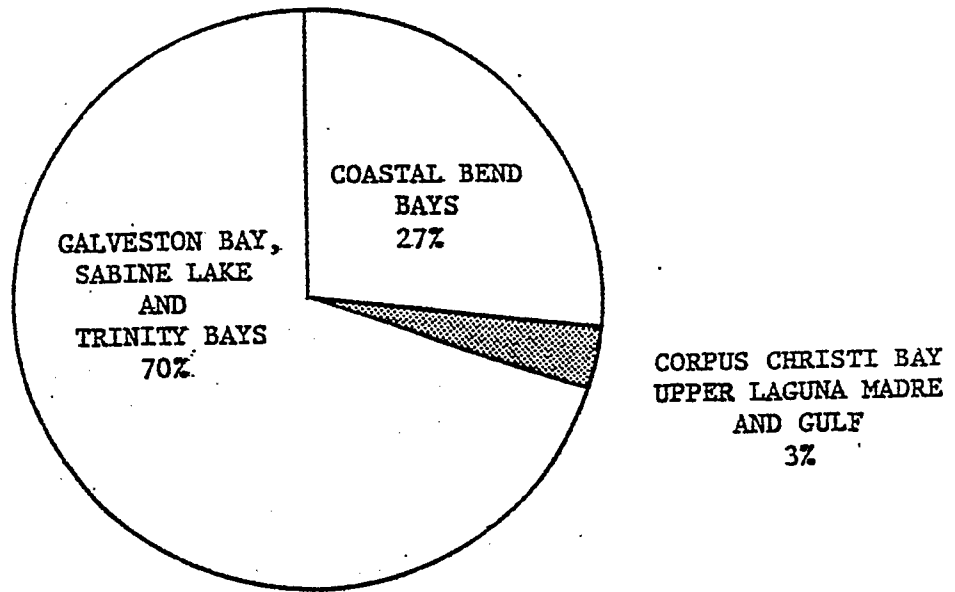

Figure B.2-26 Distribution of Total Crab Catches in Texas, 1971 (Boykin, 1972).

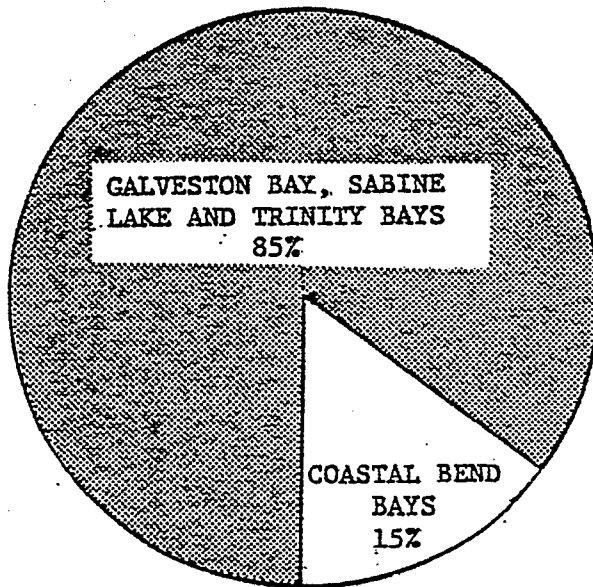

Figure B.2-27 Distribution of Total Oyster Harvest in Texas, 1971 (Boykin, 1972).

the winter and lean in the summer and fall after they have spawned. It appears that the fatness of the oysters corresponds to the peak bloom of plankton organisms, which occurs during the winter and spring (Gunter, 1967). Two critical periods exist for oysters: (1) the winter-spring, when highest quality is attained from plankton blooms, and (2) immediately after spawning, when the larvae may exhibit vertical migration in the water column before settling as a spat.

B.2.5.5 Important Recreational Species of the Region

Cameron Parish

The main game mammals in marsh areas in western Cameron Parish are white tailed deer (*Odocoileus virginianus*) and rabbits. Squirrel hunting is more important in timbered areas in Calcasieu Parish to the north. Most of the deer population in the coastal marshes is free from hunting pressure, since marsh conditions are not conducive to hunting (U. S. Army Corps of Engineers, 1975). During 1973-1974, 266 deer were killed by hunters in the parish. Hydrophytic forbs* and woody plants comprise much of the diet of such marsh deer (Lowery, 1974). They may be stressed by prolonged periods of high water during which they are found to move to natural ridges and elevated dredge disposal areas. Many of the deer may starve if high water persists long enough for the food supply to be depleted (U. S. Army Corps of Engineers, 1975). The marshes support approximately one deer per 82 acres (Lowery, 1974).

The two species of rabbits in coastal Louisiana, both hunted, are the eastern cottontail (*Sylvilagus aquaticus*). Cottontails are found mainly in dryer areas (e.g., old fields, fence rows, and well drained woodlots). Swamp rabbits frequent wet woodlands, marsh ridges and dredge disposal areas. The disposal areas commonly support large rabbit populations (U. S. Army Corps of Engineers, 1975). Both species of rabbits feed upon a wide variety of vegetation, especially grasses and legumes.

Ducks, geese, and other waterfowl are the main birds present in the Louisiana coastal zone, including western Cameron Parish. They are important with respect to hunting and bird watching. Coastal Louisiana, bordering swamp areas, and the rice region of southwest Louisiana collectively make up the largest waterfowl wintering area in the United States (U. S. Army Corps of Engineers, 1975).

Some several million ducks arrive in winter from northern breeding grounds. Additional millions stop over in the area to feed and rest before continuing across the Gulf of Mexico to wintering areas in South and Central America. Only five species of the 31 recorded from Louisiana are known to have breeding populations in the state, but only one, the Mottled Duck, probably breeds in western Cameron Parish.

*forbs - herbaceous plants other than grasses.

Nearly all ducks in the area are winter residents or transients on their way south. The Fulvous Tree Duck, which is uncommon in the area, is recorded for summer; and some other species are also occasionally represented there. The numbers of ducks along the coast are presented in Table B.2-17. The ducks and geese present in Sabine National Wildlife Refuge, and their general occurrence from season to season, are presented in Table B.2-18. These are regarded as representative of the western part of the parish.

Ducks may be broadly classified as dabblers or divers. Dabblers include: Mallards, Pintails, Blue-winged and Green-winged Teal, Gadwall, Wigeon, Shovelers, and other ducks that feed in shallow water by tipping and dabbling. These ducks rarely dive except to escape danger. They rise vertically when taking flight from land or water. Their diet is mostly vegetable, and includes wild millet, red rice, paspalum, smartweed, and signal grass. Divers include: Scaup, Ringnecked duck, Redheads, Canvasbacks and other ducks that dive for food. These ducks may be found feeding in inland water bodies or in Gulf waters. Diet consists of submerged aquatic vegetation and small aquatic fauna, with animal matter generally comprising more of the food intake than vegetable matter. Dabblers are generally of greater importance to waterfowl hunters. This is because the high vegetable content of their diet renders them more palatable than ducks consuming large amounts of animal matter. Redheads and Canvasbacks are an exception however, for they are divers which feed primarily on vegetation. Submerged plants which they ingest include: pondweeds, musk grass, sedges, wild rice, and wild celery.

Fresh marsh is the preferred marsh habitat of dabblers. This marsh type annually supported 36 percent of the seasonal dabbler population in one study. Intermediate, brackish, and saline marsh supported approximately 28 percent, 27 percent and 2 percent of the dabbler population, respectively (U. S. Army Corps of Engineers, 1975). Wintering ducks comprised the following average percentage of the annual duck kill in the state during the 1972-74 seasons: Green-winged Teal, 17 percent; Mallard, 15 percent; Blue-winged Teal, 14 percent; Gadwall, 8 percent; American Wigeon, 6 percent; and Shoveler, 4 percent (Louisiana Wildlife and Fisheries Commission, 1972-74 in U. S. Army Corps of Engineers, 1975). All other seasonal species comprised less than 1 percent each.

Table B.2-17 Estimates of waterfowl in southwest and southeast Louisiana marshes* during December, 1972. (information courtesy H. Bateman, Louisiana Wildlife and Fish. Comm.).

SPECIES**	SOUTHWEST	SOUTHEAST	TOTALS
Mallard	224,000	117,000	341,000
Gadwall	521,000	582,000	1,103,000
Baldpate	296,000	341,000	637,000
Green W. Teal	455,000	253,000	708,000
Blue W. Teal	66,000	94,000	160,000
Shoveler	118,000	81,000	199,000
Pintail	212,000	246,000	458,000
Mottled Duck	32,000	26,000	58,000
TOTAL DABLERS	1,924,000	1,740,000	3,664,000
Redhead	NO ESTIMATE	NO ESTIMATE	-
Canvasback	NO ESTIMATE	NO ESTIMATE	-
Scaup	(150,000 offshore) 4,000	(500,000 offshore) 4,000	(partial estimate) 658,000
Ringnecked	31,000	11,000	42,000
Ruddy	TRACE	TRACE	TRACE
Hooded Merganser	4,000	6,000	10,000
TOTAL DIVERS	189,000	521,000	710,000
TOTAL DUCKS	2,113,000	2,261,000	4,374,000
Coots	599,000	1,017,000	1,616,000

* Below U.S. Hwy. 90

** Wood ducks and geese not censused and black ducks are included with Mottled ducks.

Table B.2-18

OCCURRENCE OF DUCK AND GEESE
IN SABINE NATIONAL WILDLIFE REFUGE

<u>Species</u>	<u>S</u>	<u>S₁</u>	<u>F</u>	<u>W</u>
Canada Goose			o	u
White-fronted Goose	o		o	u
Snow Goose--White Morph.	c		c	a
Snow Goose--Blue Morph.	c		c	a
Ross' Goose				r
Fulvous Tree-Duck		u	u	
Mallard	c		c	a
Black Duck	u		u	c
Mottled Duck*	c	c	c	a
Gadwall	c		c	a
Northern Pintail	c		c	a
Green-winged Teal	c		c	a
Blue-winged Teal*	c	o	a	a
Cinnamon Teal	r		r	r
Northern Shoveler	c	o	c	a
American Wigeon (Widgeon)	c		c	a
Wood Duck		r	u	u
Redhead	u		u	u
Ring-necked Duck				u
Canvasback				u
Lesser Scaup	c	o	c	c
Common Goldeneye			o	o
Rufflehead				u
Ruddy Duck	u		o	u
Hooded Merganser			o	u
Common Merganser	r			r
Red-breasted Merganser				u

S--March - May

*Nests on refuge.

S₁--June - August

F--September - November

W--December - February

a--abundant, a common species which is very numerous.

c--common, certain to be seen in suitable habitat.

u--uncommon, present, but not certain to be seen.

o--occasional, seen only a few times during a season.

r--rare, seen at intervals of 2 to 5 years.

Source: U.S. Fish and Wildlife Service, United States Department of the Interior, 1974 (April), Birds of Sabine National Wildlife Refuge: RF 4358200-2.

season, an estimated 720,000 man-days were spent hunting ducks (Louisiana Wildlife and Fisheries Commission, 1974, in U.S. Army Corps of Engineers, 1975). Management practices used to improve coastal duck habitat center mainly around manipulation of water levels. Fresh to slightly brackish water one to six inches deep produce preferred food plants and ideal feeding conditions. Spring drawdowns favor the production of annual grasses, and those areas can be reflooded after the seeds mature. Such management practices may increase duck usage of an area by eightfold (U.S. Army Corps of Engineers, 1975). There are three freshwater impoundments in the Sabine National Wildlife Refuge.

Rice may comprise 80 percent of the diet of mallards and pintails, and even fallow rice fields provide excellent food if managed properly. Rice irrigation reservoirs provide additional wintering habitat and may be drawn down in summer to favor the production of annuals. Dredged material disposal levees are not used significantly by waterfowl (U.S. Army Corps of Engineers, 1975).

Three species of geese winter in coastal Louisiana: the Canada Goose, the snow Goose (which includes the blue goose), and white-fronted goose. Canada goose populations wintering in Louisiana have been greatly reduced in number because of the development of good wintering areas in states farther north. Snow geese are commonly found in brackish marshes, rice fields, and pastures. They are primarily grubbers, and in the marshes feed upon the rhizomes of three-cornered sedge, wire grass, and delta duck potato. The considerable grit required for digesting this type of food is obtained from scattered sand banks. In agricultural areas, Snow Geese consume the unharvested waste grain of rice, soybeans, and sorghum, as well as wild seeds of sprangletop and wild millet. The White-fronted Goose feeds predominantly in grain fields and pastures, sometimes also using fresh marshes. Marsh burning is a major management tool. Proper burning provides access to the plant roots with later growth of new grass available for grazing. Unburned stands of three-cornered sedge may be used by feeding flocks of geese. Mature wire grass is too rank and tough, and consequently only the young shoots which have been stimulated by burning are palatable. Burning in proper management involves a burn two to three days prior to use. The rapid rate of revegetation along the Gulf Coast renders a marsh burn unattractive to feeding geese after about a week or 10 days even during the winter. Thus, a series of controlled burns is best for providing food for sustained periods (U.S. Army Corps of Engineers, 1975).

The American Coot (Fulica americana), a small duck-like bird which nests in freshwater lakes and marshes, nests in Sabine National Wildlife Refuge. It is common in every season but summer. These birds feed mainly on aquatic vegetation and frequently mingle with dabbling ducks. More of them (457,000) than the most commonly taken duck (the Green-winged Teal with 353,000) have been taken (1973-74; U.S. Army Corps of Engineers, 1975).

Other game birds include the King Rail, Clapper Rail, Virginia Rail, Sora, Purple Gallinule, Common Gallinule, Common Snipe, and American Woodcock. These are all found in Sabine National Wildlife Refuge. The King Rail, Clapper Rail, and gallinules also nest there (U.S. Fish and Wildlife Service, 1974). These birds are found in aquatic habitats with the woodcock and snipe associated with marshes, wet meadows, and swamps; the rails associated with marshes and the gallinules associated with shallow, fresh ponds. In 1972-73, there were 41,000 woodcock hunters, 20,000 snipe hunters, 13,000 rail hunters, and 8,000 gallinule hunters (U.S. Army Corps of Engineers, 1975).

Such sport fish species as buffalo, freshwater drum, white, yellow, and largemouth bass are found in the freshwater or nearby freshwater channels. In backwaters, ponds, and impoundments such recreational species are present as: bowfin, chain pickerel, green sunfish, warmouth, bluegill, longear sunfish, redear sunfish, largemouth bass, and white and black crappies are characteristic (U.S. Army Corps of Engineers, 1976). Other sport species which may be present include blue and channel catfish (U.S. Army Corps of Engineers, 1975). Sport species of more saline waters include spot, red drum, sea trout, black drum, southern flounder, and sheepshead (U.S. Army Corps of Engineers, 1975 and 1976). Most of these sport fish found in higher salinity water are also commercially important and are discussed under Section B.2.5.3 (Important Commercial Species of the Region). There is also a description of fishes in relation to their regional habitats in Section B.2.5.1 (Ecosystems).

Shrimp, crabs, and oysters are taken by individuals in the area for their personal use. Oyster collecting is restricted to tonging and is only permitted in West Cove and the lower part of Calcasieu Lake in the Calcasieu system. The Louisiana Wildlife and Fisheries Commission issued 307 licenses for oyster collecting in this area for 1975 and estimated that 440,000 sacks were available for harvest in 1976 (U.S. Army Corps of Engineers, 1976).

Calcasieu Parish

Calcasieu Parish is typical of most of the Texoma study area in its suitability for game birds, although it probably ranks after Cameron Parish and Jefferson County in importance in waterfowl hunting. The Mottled Duck and Blue-winged Teal are the important resident birds in the marsh area along with the Clapper Rail, the King Rail, and the Wood Duck. Upland resident game birds found on second-growth land are the Bobwhite and Mourning Dove.

Several important migratory game birds utilize the parish marshlands: the Snipe, Woodcock, Mourning Dove, Mallard, Pintail, Green-winged Teal, Gadwall, Fulvous Tree Duck, Canvasback, Red-head, Greater and Lesser Scaup, several species of goose, Shoveler and Wigeon. It has been estimated that 20% of North American waterfowl winters in the marshes of Louisiana. Because of the numbers of birds and the interest in waterfowl hunts, Louisiana is able to draw a sizable revenue from the sale of hunting permits compared with other states with lower waterfowl potential.

Trapping was mentioned in Section B.2.4.3 (Important Commercial Species of Region) as being very important commercially in the marsh area of Calcasieu Parish. However, 50% of the licensed trappers of the parish are from outside the marsh and are "free lance" operators, trapping on upland areas (O'Neil and Linscombe, no date). Upland trappers set traplines along logging roads and creek bottoms. Catches are made up mainly of raccoon; however, red fox and coyote are taken, as well as bobcat and nutria when they are available.

Orange County

Most of the waterfowl which visit Orange County are transients on their way to or which will return to marsh and associated areas to the south in Jefferson County or elsewhere. These species are generally the same as those listed for western Cameron Parish.

The main game mammals in the county probably include whitetailed deer, squirrels (gray, Sciurus carolinensis and fox, Sciurus niger), and eastern cottontail rabbits. The game birds, Bobwhite and Doves, probably are also hunted in the area.

Fishing is popular on Cow and Adams Bayous (Fisher, et al., 1973) and on the Sabine River and ponds, lakes, and other water bodies in the interior of the county.

Food and game fish recorded from the Sabine River are regarded as typical species in the area. They include: largemouth bass, spotted bass, white crappie, black crappie, bluegill, longear sunfish, orange-spotted sunfish, spotted sunfish, carp, river carpsucker, spotted sucker, blue sucker, striped mullet, channel catfish, flathead catfish, blue catfish, yellow bullhead, and the spotted gar (Lantz, 1970).

Jefferson County

Texas ranks among the leading states in the sports of hunting and fishing. In the federal fiscal year of 1974, 1,105,905 and 1,598,236 hunting and fishing licenses were held, respectively. These sports constitute a major part of the state's \$4.8 billion tourism and recreation industry.

White-tailed deer is the single most important game animal in Texas, and deer leases are a significant source of income for many landowners. Wild turkey, quail, doves, ducks, and geese are the other primary game in the state. The coastal area of Jefferson County, particularly around Port Arthur, which is an excellent hunting ground for both ducks and geese.

During 1975, an estimated 3 million fishermen had spent more than 64 million days fishing on 2.8 million acres of Texas inland waters (estimated by Texas Parks and Wildlife). Important recreational freshwater species include: sunfish (largemouth bass, Micropterus salmoides; and crappie, Pomoxis sp.); bass (striped bass, Morone saxatilis, and white bass, Roccus chrysops); catfish (channel, Ictalurus punctatus; and blue, I. furcatus). Jefferson County's recreational freshwater fishery consists primarily of the species mentioned above.

The saltwater sport fishing is prominent in both the inshore waters as well as offshore in the Gulf of Mexico. Presently, studies are being initiated to census this activity, but little is known at this time. The more popular saltwater fish include: croakers, sea trout, flounder, redfish, sheepshead, and drum. Jefferson County's saltwater fishery centers around the Sabine Lake where the prevalent species are: speckled trout (Cynoscion nebulosus), redfish (Sciaenops ocellata), black drum (Pogonias cromis), Atlantic croaker (Micropogon undulatus), gaftop catfish (Bagre marina), southern flounder (Paralichthys lethostigmus), and sheepshead (Archosargus probatocephalus).

Crabbing for blue crabs (Callinectes sapidus) is also a popular recreational activity in both the state and in Jefferson County.

B.2.6 Natural and Scenic Resources

B.2.6.1 Wildlife Refuges

Sabine National Wildlife Refuge south of the ICW is the largest waterfowl refuge on the Gulf Coast covering 142,846 acres. Figure B.2-28 indicates the location of the refuge relative to Texoma sites and facilities. The original intent in establishing the refuge was to provide protection to marsh habitat important to wintering snow geese and ducks. Coastal marshes in southwest Louisiana were formally one of the most famous fur producing areas of the country. But access canals dug through this area have changed the ecological and hydrologic situation considerably by blocking the drainage of fresh water and allowing the intrusion of salt water. One of the management goals of Sabine Refuge is the re-establishment of a high quality marsh habitat over a large area through proper manipulation of water levels (U. S. Department of Interior, 1974).

During the Christmas season each year, birdwatchers cooperate with the National Audubon Society in making "Christmas counts" of birdlife in numerous areas across the United States. The Sabine National Wildlife Refuge - Cameron Count has been made 18 times since 1950. In 1959, the census recorded 163 species, which is the largest number of species ever observed in Louisiana for a winter day (Lowery, 1974). This number is exceptionally large even when comparisons are made with similar counts in other areas of the United States. Part of the reason for this high count is that the 15-mile diameter of Sabine Refuge - Cameron census area includes a variety of different habitats such as Gulf beaches, heavily wooded upland forests, and pine savannahs. These habitats in turn have distinctly different varieties and numbers of birds.

Sydney Island, is a private wildlife refuge managed by the National Audubon Society, (Figure B.2-28). It is located at the northern end of the Sabine Lake. The island has been in existence since 1915, when it was created as a spoil island from sand and silt dredged from the adjacent waterway. Although only 126 acres in size, it has an extremely large concentration of nesting birds, mainly egrets, herons, night-herons, and ibis. In addition, it has one of the largest colonies of Roseate Spoonbills in the United States, with 600 nests counted in 1975 (Bailey, 1976). Similar islands on Sabine Lake lack sizable bird population due to the disturbing effects of human habitation and the presence of cattle and hogs.

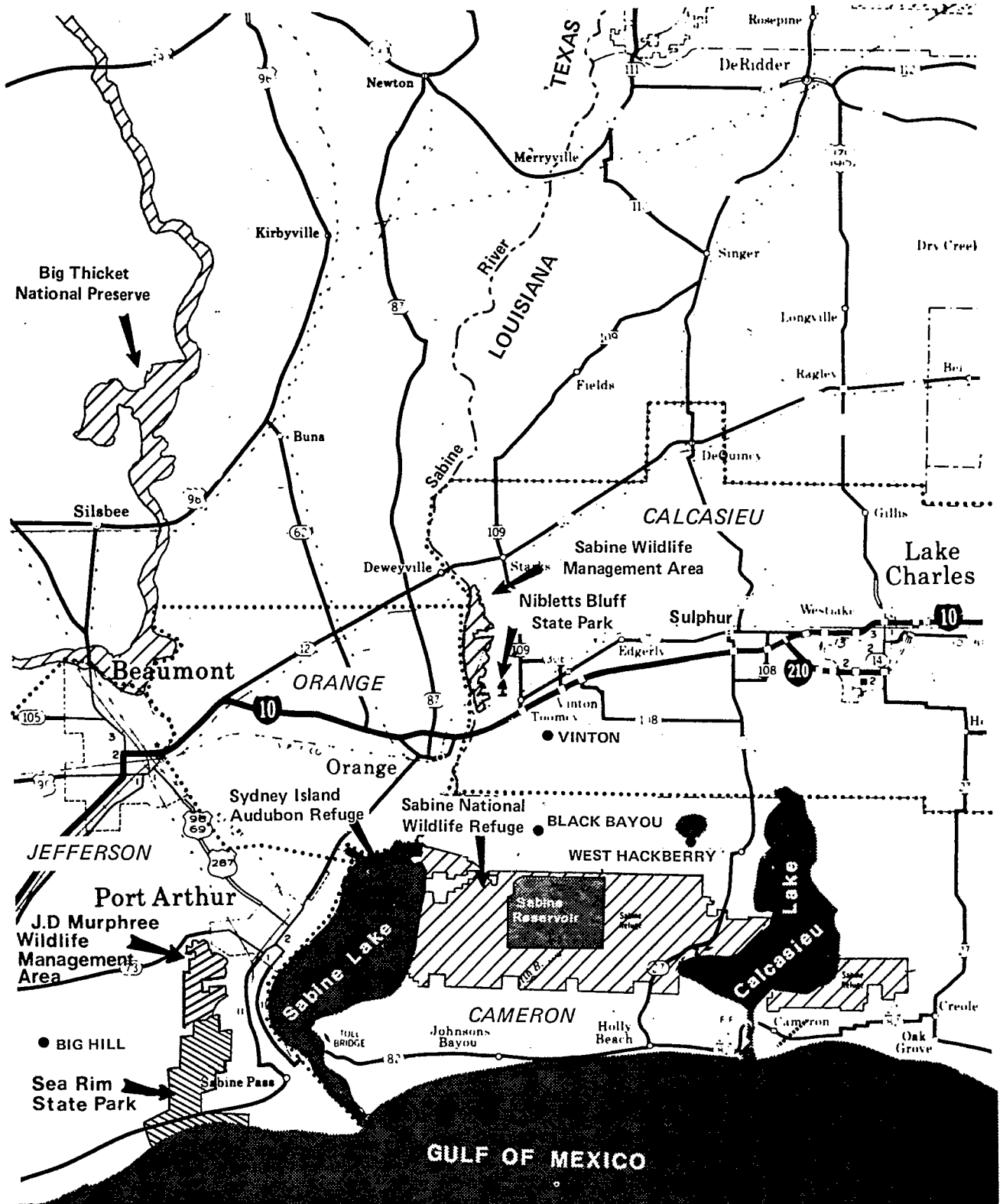

FIGURE B.2-28 Locations of parks, preserves, refuges and management areas in the Texoma area.

B.2.6.2 State and National Recreational Parks

Northwest of Beaumont, Texas is the newly created 84,500 acre Big Thicket National Preserve covering parts of seven counties. Managed in disjunct units with stream corridors, the preserve was created to save excellent examples of southern swamp and upland forest habitat, known locally as "the Big Thicket." This area is unique ecologically in that plant and animal life from widely different areas live together here naturally. Plant life in the Thicket such as "raindeer moss" from the arctic has been found close to subtropical palmetto commonly found in Florida. The Roadrunner also shares the same terrain with forest inhabiting birds like the Eastern Wood Thrush.

The only officially designated park areas in the vicinity are Nibletts Bluff State Park and Sea Rim State Park, about 12 miles west of Sabine Pass. Nibletts Bluff State Park is located near the Sabine River approximately 10 miles northeast of Orange, Texas. Activities such as picnicing, boating, fishing, and camping can be pursued there. Sea Rim State Park has marsh and beach areas and provides camping and picnicing facilities. In addition, two miles west of Nibletts Bluff is the Sabine Wildlife Management area (see Figure B.2-28). Covering approximately 9,000 acres, the area is managed primarily for waterfowl hunts. J. D. Murphree Wildlife Management Area is located on the north side of the ICW close to Sabine Lake. It is also managed for waterfowl.

B.2.7 Archaeological, Historical, and Cultural Resources

Coastal Louisiana and Texas are rich in archaeological sites; there are more than 700 known sites in coastal Louisiana alone. Prior to the implementation of the National Environmental Policy Act of 1969, these sites received little protection and many were destroyed either by accident or purposely by amateur collectors. Today the attitude of state and federal archaeological offices is that these sites should be preserved intact, except in such cases where human welfare would be improved as a result of some act (i.e., construction) that would alter a site. In the latter instance, a comprehensive investigation of the site could be recommended prior to disturbance of the site.

A large number of the known archaeological sites are in the form of shell middens, which are composed of refuse discarded by Indians who lived in the area. The middens are composed mostly of shells of the brackish-water clam Rangia cuneata, but also often contain shells of Crassostrea sp. and Unio sp. Among the shells can be found pottery fragments, ash, bones of various animals, arrowheads, and implements indicating the life style of the inhabitants of the region. Most of the early sites can be dated at between 300 and 400 A.D. The oldest sites known in the area are thought to be from the Archaic Period around 1500 B.C. and the most recent was in the Historic Period around 1500 A.D. (Bollich, 1976).

Although few archaeological investigations have been made of the salt dome areas of Cameron and Calcasieu Parishes and Jefferson and Orange Counties, it is suspected that they would yield valuable information once surveys are undertaken. Because of their generally higher topography, they are thought to be used from very early times as hunting or village sites. Avery Island, a salt dome "island" in south-central Louisiana, has yielded evidence of man's earliest occurrence in the delta region. A large solution pond on the surface of the Avery Island salt dome contained the remains of extinct Pleistocene vertebrates, various stone tools, wooden artifacts, and projectile points. Radiocarbon dating indicated the age of some of the artifacts at greater than 11,500 years old (Gagliano, 1967).

The Pre-Columbian native inhabitants of the Texoma area were Atakapa Indians, who occupied a number of locations in Louisiana on Vermilion Bayou, along the Mermentau River, on lakes near the mouth of the Calcasieu River, and presumably along the lower Sabine River (Swanton 1911). These groups, together with the Akokisa of Texas and the Bidias and Deadose, make up what Newcomb (1961) calls the "provincial Atakapa." Their name, given them by the French, is a Choctaw word meaning "man-eater," and is derived from the ominous reports of cannibalism among these people. Although the Bidias and the Deadose were affiliated linguistically and culturally with the Atakapa of Louisiana, they were often considered distinct Indian groups. The Akokisa of Texas, however, are believed to have been a western extension of the Atakapa proper of Louisiana (Swanton, 1946). The available ethnographic and historic information on the Atakapa of Louisiana and Texas is not extensive, but, from the reports that do exist, the Indians are felt to be among the most primitive in North America.

The earliest details of Atakapa culture come from the memoirs of Simars de Belle-Isle, a French ensign who was enslaved by the Texas Akokisa after being set ashore and abandoned by his captain (Margry 1877-86). De Belle-Isle's memoirs extend over the entire period of his captivity, from 1719-92, during which time he had ample opportunity to observe the Akokisa and learn their culture. Following the Louisiana purchase of 1803, a series of land claims which particularize business proceedings between the colonists and the Atakapa provides additional information on the aboriginal culture. Later, in 1817-19, J.O. Dyer wrote on the Lake Charles Atakapa (the last remaining vestige of the Calcasieu band) based on observations and conversations with informants (Dyer, 1917). These few scattered reports represent the primary sources on the culture of the Atakapa.

When viewed from the perspective of the Lower Mississippi Valley, the Atakapa culture area is often referred to as a "cultural sink," or as Gibson (1976) states, "an area that progress seemingly forgot." Though isolated for some time from European settlement, there are reports of some incidence of trade among the Atakapa with pottery vessels and stones for lithic manufacture obtained from inland tribes and globular oil jugs from the Karankawa (Dyer, 1917; Gibson, 1976). In exchange for these items, the Atakapa offered salted fish and cane baskets. The Indians finally entered into fur, horse, and tallow bartering when the western expansion of Europeans brought white traders and settlers into the area.

Although their linguistic affiliate, the Bidias, and other inland tribes were said to be horticulturalists, the Texas Akokisa and the Louisiana Atakapa either did not practice horticulture or it was not vital to subsistence (Newcomb, 1961). Semi-nomadic in their settlement, the Atakapa engaged in hunting, gathering, and fishing. Gibson quotes Newcomb (1961) as saying that during the spring and summer months, these Indians divided themselves into small family groups concentrated along the coast, gathering shellfish, including *Rangia* and oysters, bird eggs, water lotus rhizomes and seeds, and fishing. In fall and winter, the Atakapa reportedly moved inland to join other families in semi-permanent settlements. A question should be raised regarding the reasons why the Atakapa broke into small family groups in the coastal zones where a major food source, *Rangia cuneata*, is abundant, and does not vary in quantity from season to season (Tarver, 1972). It is more often customary, e.g., in the Great Basin for people to come together at times and in places where the food supply is the most plentiful and reliable. Additionally, Newcomb was speaking specifically of the Texas Akokisa; whether this migration pattern was followed by the Louisiana Atakapa is not known.

The Atakapa survived by exploiting their ecological niche to the fullest. Hunting alligator, deer, bear, small animals, and, it is rumored, humans, they developed their technology to obtain food from the kill of moving animals. Among the Atakapa weaponry figured the bow and arrow, bone and antler tipped spears, two kinds of fish darts, harpoons, brushwood and cane traps, and oyster rakes (Newcomb 1961; Dyer 1917). Their technology also included the manufacture of cane baskets (used in trade), wooden bowls and skin containers, digging sticks, and dugout paddles.

Among the Lake Charles Atakapa, houses were conical and made of bent-poles interlaced with vines, and presumably thatched with holes for smoke release (Dyer, 1917). To the north of the Atakapa proper, the Bidias used tents during the winter months, but it is not known the extent to which (if at all) tents were used among the Louisiana Atakapa.

Beyond the technology and material culture, little is known of the religious and social systems of the Atakapa. The information available points to a band organization, strong natural division of labor (based on age and sex), leadership limited to advice and movement coordination, and a lack of formal religious organization. Historical data support the suggestion that shamans probably occupied an elevated position in the social structure, because they were reported to have established their lodges and huts atop shell mounds (Newcomb, 1961).

Until the mid-1700s, the Atakapa culture remained virtually undisturbed. Possibly owing to their sinister reputation as cannibals, the Atakapa did not experience an early intrusion of European settlers as did their neighbors to the east and further inland.

Archaeological records of the Texas Historical Commission in Austin were checked for all known sites within one mile on either side of the proposed pipeline routes and in the vicinity of the Big Hill salt dome. Twenty-five sites were found to occur within this area. From the files of the Louisiana Archaeological Survey and Antiquities Commission in Baton Rouge, twelve archaeological sites were found to occur within one mile of the sites and proposed pipeline routes in Louisiana.

Areas officially designated by the government as having historic value are listed in the National Register of Historic Places. A search of the National Register for the counties of Jefferson and Orange, and the parishes of Cameron and Calcasieu, lists the following areas of historical importance (National Park Service, 1977).

Jefferson County

- (a) The Lucas Gusher, Spindletop Oil Field, three miles south of Beaumont.
- (b) French Home Trading Post at 2995 French Road, Beaumont.
- (c) McFaddin House Complex at 1906 McFaddin Street, Beaumont.
- (d) Pompeiian Villa at 1953 Lakshore Drive, Port Arthur.

Orange County

W. H. Stark House, 611 W. Green Avenue, Orange.

In Cameron and Calcasieu Parishes, Louisiana, there are no locations listed in the National Register. However, there is a shell midden in Cameron Parish, 1-1/2 miles from the proposed pipeline route which is being considered for nomination to the National Register. This is the Gill Smith Archaeological Site. The site is approximately 2 acres in size and represents a perfect example of high quality coastal shell midden (Gibbens, 1977).

There are many historical places which are listed only on state registers and are given protection by various state laws. State historical offices in Texas and Louisiana provided information on the locations of these sites in the four parish/county study area. Louisiana was found to have three historic marker locations in Calcasieu Parish, and none in Cameron Parish (Munson, 1976). In Texas, 33 historic markers are located in Jefferson County, and four in Orange County (Texas Historical Commission, 1975).

A cultural Resource Survey has recently been completed for Black Bayou, Vinton, and Big Hill storage sites and their associated pipeline routes. The West Hackberry brine pipelines were also surveyed for this same project. However, the West Hackberry storage facility and oil pipeline route are being evaluated by a separate survey which is being conducted within the Federal Energy Administration's ESR Program. This program is described in the FES 76/77-4 (FEA, 1977).

The purpose of the Texoma cultural resource survey was to evaluate, using a statistically valid sampling procedure, the probability of encountering valuable archaeological or historical sites around any of the storage facilities or pipelines. In this way potential storage areas could be evaluated and compared to determine which particular area would be least affected by the proposed action. Once the site which would function as the SPR facility is chosen, a more intensive cultural resource survey would be undertaken. This second survey would supply information necessary for compliance with the National Historical Preservation Act of 1966 and Federal Executive Order 11593. The National Historical Preservation Act requires that Federal agencies should determine the effect of any action of their department on a National Register property and allow the Advisory Council on Historic Preservation an opportunity to comment on the proposed project. Executive Order 11593, issued in 1971, expanded further the role Federal agencies were to play in historic preservation. It directs heads of Federal agencies to locate, inventory, and nominate all sites, buildings, districts, and objects under their jurisdiction that appear to qualify for listing in the National Register of Historic Places. In addition, both Federal directives state that the Federal agency should consult with the appropriate State Historic Preservation Officer in order to coordinate their responsibilities regarding cultural preservation.

B.2.8 Socioeconomic Characteristics

The region encompassing the Texoma group of candidate petroleum storage sites and related pipelines, includes Cameron and Calcasieu Parishes in Louisiana, and Jefferson and Orange Counties in Texas. Since one of the candidate sites lies within 7 miles of the border of Chambers County, this county has also been included as part of the study region. All the salt domes under consideration are located in rural areas, and the labor force required by the proposed project would be derived primarily from urban areas within this region.

B.2.8.1 History and Cultural Patterns

The coastal area of the border region between Louisiana and Texas was once inhabited by the Atakapa tribes, who were farmers and fishermen. Shell middens left by these Indians are found along the rivers and on the islands of the marshes.

Both Spain and France claimed land in this region during the 16th Century. Spanish rule became established in Texas and, in 1762 Spain was granted most of Louisiana eastward to the Mississippi River. During the following years, the French and Acadian population of this eastern portion of Spanish territory grew rapidly. In 1800 Napoleon obtained the return of land west of the Mississippi to a river which, by its description, could have been either the Sabine River or the Calcasieu River. Both Spain and France claimed the land between these rivers, so it was established as neutral ground. This area became a haven for outlaws, pirates, and smugglers. French Louisiana was sold to the United States and became a State in 1812. Spain ceded its claim to the land east of the Sabine River in 1819. Three years later, Mexico won independence from Spain. The Texas portion of the Mexican land, however, was settled by an increasing number of Anglo-Americans who, in turn, won their independence from Mexico in 1836 and were admitted as a State in 1845. The region retains many of the unique cultural aspects of the people who settled it. Family names, place names, and the local cuisine indicate its Indian, French, and Spanish heritage.

The natural resources of the region have had a strong influence on its pattern of development. Oil was discovered in Calcasieu Parish in 1886, and at Spindletop in Texas in 1901. A period of rapid industrialization followed the discovery of oil, and many refineries and petrochemical plants were built around the major port cities. The extensive coastal marshlands of the region are sparsely populated, and provide large areas for hunting, fishing, and trapping.

B.2.8.2 Population

Population Density and Distribution. Of the five parishes and counties in the study region, Jefferson County has the highest population, due primarily to the high proportion of urban development. Regional population, in general, is concentrated in the inland areas, away from the coast. Cameron Parish and Chambers County lie along the coast and have no communities with populations in excess of 2,500. Similarly, the coastal subdivision of Jefferson County is entirely rural, and has a population of only 1,486 (Census, 1970). Table B.2-19 shows the population distribution of the five parishes and counties in the region, and the balance between urban and rural sectors.

Major Towns and Cities. There are four major cities in the region, as shown in Figure B.2-29. Included are: Lake Charles Louisiana; and Beaumont, Port Arthur, and Orange, Texas. Most of the labor force required for the project would commute from these cities, and materials consumed by project construction would be manufactured in or shipped through these cities.

Lake Charles. The population of Lake Charles was about 78,000 in 1970 and dropped to about 74,000 in 1975 (Lake Charles American Press, 1976). Before the discovery of oil in Calcasieu Parish, Lake Charles was primarily a lumber port. It is now a major manufacturing center, particularly for the chemicals industry. Lake Charles is the parish seat of Calcasieu Parish, and the home of McNeese University (enrollment: 5,700 students). Although the city's early population was predominantly of Scottish-Irish heritage, a later influx of French and Acadian descendents from the south-central part of Louisiana has resulted in the city having an almost equal mixture of Anglo-Saxon and French cultural influence.

Beaumont. Beaumont is one of the three Texas cities that form a large urban triangle in the region. The population of the city was just over 115,900 in 1970, and is estimated to have reached 119,600 by 1975. It originated in the early 1800s as a trading post for French and Spanish fur trappers. When oil was discovered at the Spindletop Oil Field in 1901, Beaumont became a boom town. Several refineries are located in and around Beaumont, as well as a number of chemical plants, metals industries, and machinery manufacturers, and it is a major port city. Lamar University is located here, and has an enrollment which exceeds 10,000.

Table B .2-19. Population Density of the Texoma Region

	<u>Calcasieu</u> ¹	<u>Cameron</u> ¹	<u>Orange</u> ²	<u>Jefferson</u> ³	<u>Chambers</u> ³
Total Population	145,415	8,194	71,226	244,773	12,187
Population Density (per square mile)	131.6	5.7	198.2	257.4	19.8
Urban Population	108,713	0	47,250	232,393	--
% Urban	74.8	--	66.3	94.9	--
% Change from 1960	1.17		17.7	-1.3	--
Rural Population	36,702	8,194	23,976	12,380	12,187
Farm	1,171	894	311	NA	NA
Nonfarm	35,816	7,300	23,665	NA	NA
% Rural	25.2	100	33.7	5.1	100
% Change from 1960	-3.46		18.4	22.4	17.4

¹ Public Affairs Research Council of Louisiana, Inc., Statistical Profiles based on U.S. Census of Population, 1970.

² Southeast Texas Regional Planning Commission

³ U. S. Census of Population, 1970.

B.2-131

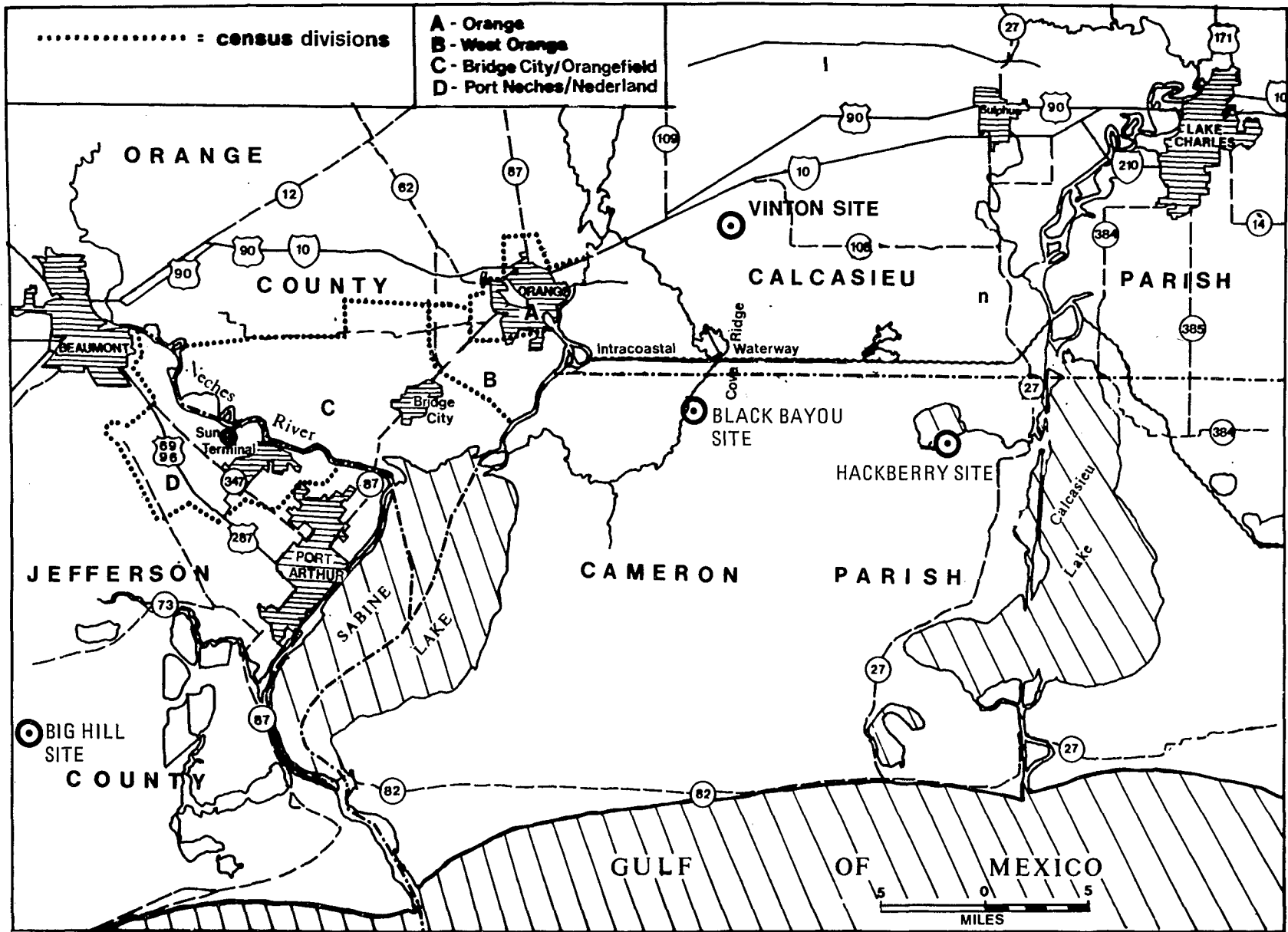

Figure B.2-29 MAJOR CITIES IN TEXOMA REGION

Port Arthur. Port Arthur is located on the western shore of Sabine Lake, and is about 16 miles from Beaumont. In 1970 its population was about 57,400, and was estimated to rise to about 58,900 by 1975. The site of the town was first settled in the 1830s and became known as "Aurora." In 1895, Arthur Stilwell, president of the Kansas City railroad, began a project to connect his railroad line to a shipping port on the Gulf. The port facilities were built at this site which then became "Port Arthur," and a canal was dug to allow ocean ships to come into the port. Petroleum products, chemicals, and fabricated metal goods are the major industries.

Orange. Orange is on the west bank of the Sabine River, 42 miles north of the Gulf of Mexico. It lies 24 miles from Beaumont and 22 miles from Port Arthur. The population was recorded as 24,500 in 1970, and is estimated to have grown to a total of about 28,700 by 1975. The city was first established in the 1830s, and was named "Orange" in 1858 because at that time there were large groves of orange trees in the vicinity. In its early years, Orange was an important port for shipping cotton and lumber. During World War II, the city population increased nearly tenfold when workers were recruited to build ships for the war effort. It is now a major petrochemical manufacturing city.

Population Projections. Population growth and projections for the region are shown on Table B.2-20. After a period of rapid growth between 1950 and 1960, Calcasieu Parish experienced a decade of marginal population decline. During that decade, however, the City of Lake Charles continued to grow, and achieved a 23 percent increase in population. The outward migration was primarily from the rural areas of the parish. Over the past 5 years, the population of Lake Charles has begun to decline, but residential communities around the periphery of the city continue to grow.

Beaumont, Port Arthur, and Orange experienced a decline in city population during the period from 1960 to 1970, ranging in magnitude from 2.7 percent to 14 percent. The trend appears to have been a migration into the surrounding suburban areas, however, since these smaller towns (Nederland, Port Neches, Bridge City, and Pine Forest) grew at a rate that more than compensated for the decline in the urban centers.

Table B.2-20 Population and Population Projections

	<u>Calcasieu</u> ¹	<u>Cameron</u> ¹	<u>Orange</u> ²	<u>Jefferson</u> ²
1950				
Population	89,635	6,244	40,567	195,083
1960				
Population	145,475	6,909	60,357	245,659
% Change	62.3	10.7	48.8	25.9
1970				
Population	145,415	8,194	71,203	246,402
% Change	-0.04	18.6	18.0	0.3
1980				
Population	163,382	9,304	91,900	256,800
% Change	12.4	13.5	29.1	4.2
1990				
Population	181,647	10,617	110,000	280,000
% Change	11.2	14.1	19.7	9.0

¹ Population Projections by the Louisiana State University, Division of Business and Economic Research, 1974 Statistical Abstract of Louisiana, 5th Edition.

² Population Projections by the South East Texas Regional Planning Commission, 1972.

B.2.8.3 Land Use Patterns and Plans

Present Land-Use

The land use patterns for the region are shown in Figure B.2-30. A dominant feature of current land use is the lack of development along the coast of the Gulf of Mexico. Most of the land along the coast is part of an extensive salt and brackish marsh that is unsuitable for agricultural use. Lack of fresh water sources and the seasonal threat of hurricanes make the coastal area less desirable for urban development than inland areas. The large area of public land shown in the figure is the Sabine National Wildlife Refuge, and is part of the marsh area.

Despite the lack of coastal development, the major urban centers of the region are port cities. Lake Charles on the Calcasieu River, Orange and Port Arthur on the Sabine River and Lake, and Beaumont on the Neches River all have large port facilities for handling cargo from ocean vessels and from barges that move along the Intracoastal Waterway. The shipping channels to these inland ports must all be dredged periodically because the rivers leading to the Gulf are too shallow for navigation by ocean vessels.

The lands adjacent to the urban centers and inland from the marshes are rich farmlands. Rice is the dominant crop grown in the region. The rice terraces must be level to provide for proper irrigation and drainage, and since the land is very flat, it is especially conducive to rice farming. There is an abundance of rainfall which aids the the growing of rice but also necessitates the construction and maintenance of drainage canals throughout the farming area. In the border area between rice fields and brackish marshes, the land is used for grazing cattle.

Further inland beyond the farming area are the forests. Most of the forest lands are privately owned and are periodically harvested for lumber.

Oil and gas fields are scattered throughout the region. The highest levels of production, however, tend to be from the fields in the coastal wetlands and offshore. Oil and gas production is classified as an industrial use of the land. Often, however, production occurs concurrently with the use of the land for grazing cattle.

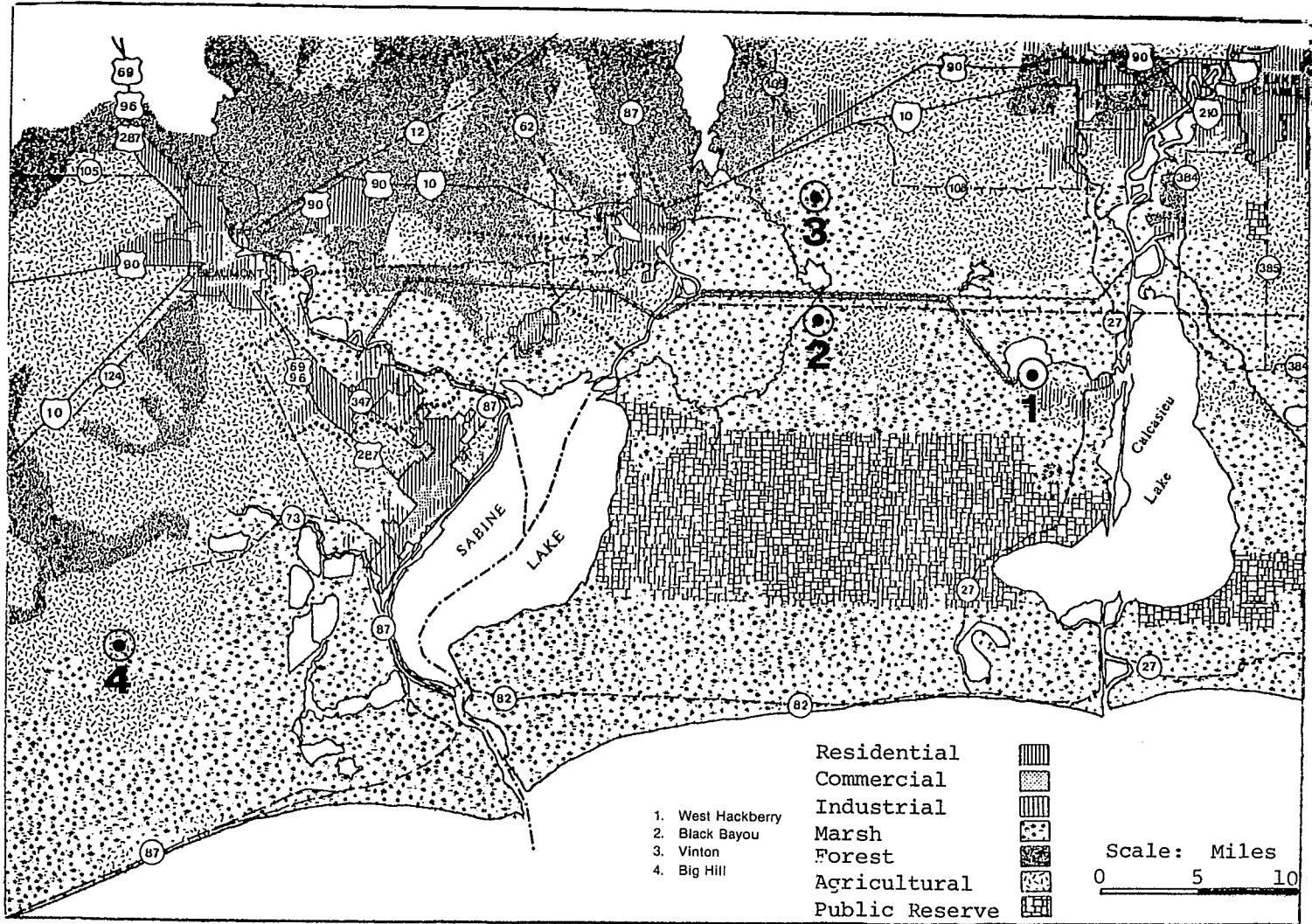

Figure B2-30 CURRENT LAND USE IN THE REGION

Future Land Use

Land use patterns anticipated to prevail in 1990 are shown in Figure B.2-31. Major changes that will occur relate to the expansion of the urban centers. Present agricultural areas are in the process of being developed into residential and commercial zones. Land along the rivers and adjacent to the cities is expected to be used by industry. In several cases (at Lake Charles and at Beaumont), low lying portions of marsh along the rivers will be filled in order to make them suitable for building purposes.

Land use planning in the region is being developed by two separate agencies. The Louisiana portion lies within a group of five parishes for which plans are being compiled by the Imperial Calcasieu Regional Planning and Development Commission. The two Texas counties comprise a region for which work is being done by the South East Texas Regional Planning Commission. Neither of these agencies has authority to limit certain patterns of development that may appear to be undesirable. Calcasieu Parish is the only governing agency that has authority to place zoning restrictions on lands outside of city limits.

B.2.8.4 Transportation Systems

Highways. The region is crossed from west to east by Interstate 10 and U. S. 90 which connect the major cities to Houston, Baton Rouge, and New Orleans. Texas State Highway 73 crosses Jefferson County, connecting Port Arthur to Interstate 10, and divides the populous northern part of the county from the rural coastal area. Texas State Highway 87 and Louisiana State Highway 82 lie along the shore of the Gulf of Mexico and are sometimes inundated during severe storms. Texas and Louisiana are divided by the Sabine River which is crossed by two bridges within this region: the Interstate 10 bridge at Orange, and a toll bridge on Louisiana 82 at the Sabine Pass. The "Rainbow Bridge" on Texas 87 crosses the Neches River between Port Arthur and Orange. It is one of the tallest bridges in the South, and rises 177 feet above the water level, allowing freighters and tank ships to navigate up and down the river. Louisiana Highway 27 is the north-south artery between Calcasieu and Cameron Parishes. It is the hurricane evacuation route for towns along the Louisiana Gulf Coast in Cameron Parish. There are few roads in the coastal areas where much of the

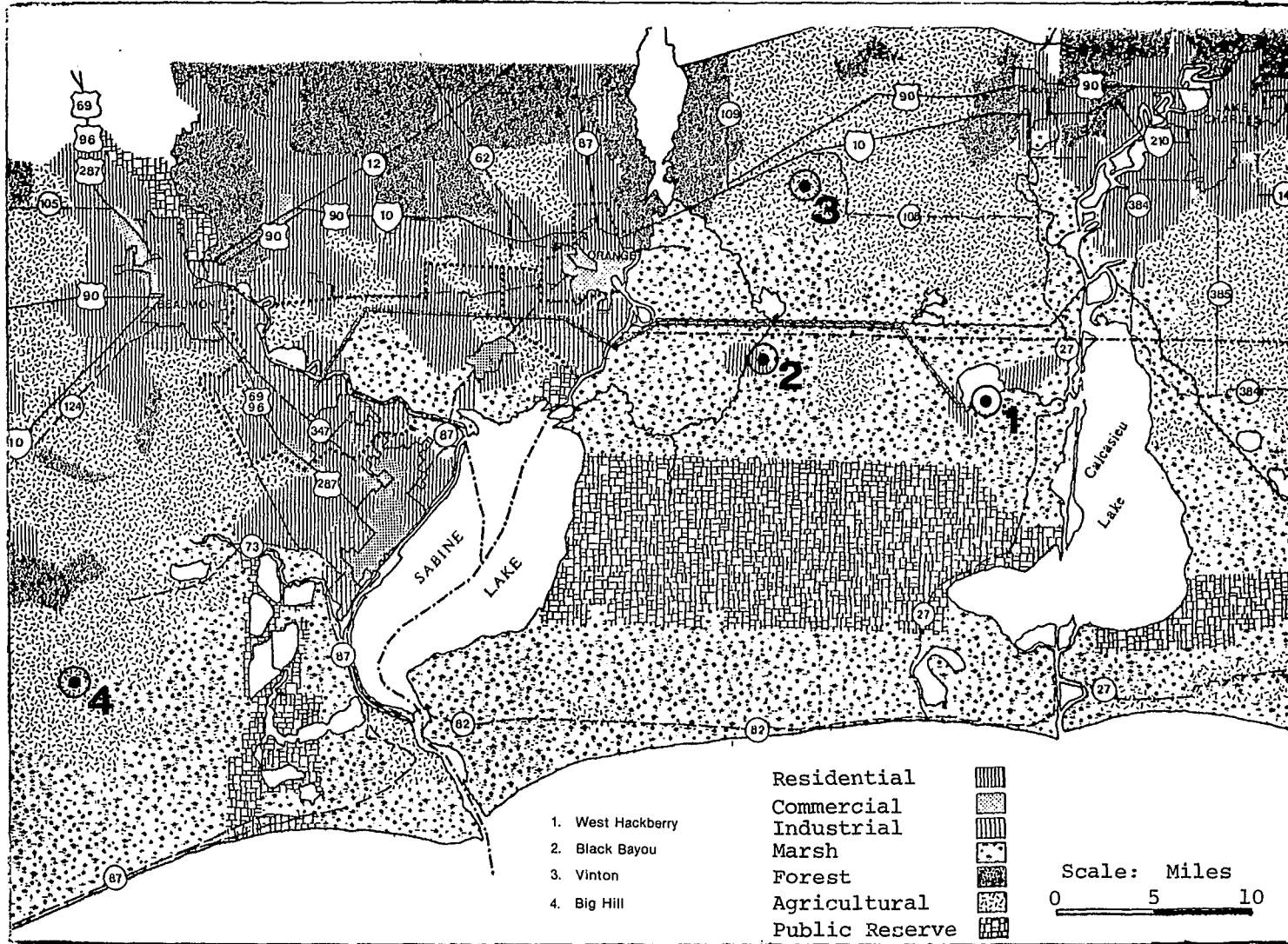

Figure B.2-31 Future Land Use Plans for the Region

land is marsh and thinly populated. Major highway systems of the area are shown in Figure B.2-32.

Railroads. The major cities in the Texas portion of the region have several railroad lines coming into them. Among these are: the Southern Pacific, the Kansas City Southern, and the Missouri Pacific. The Southern Pacific Railroad crosses the Sabine River and goes into Lake Charles, Louisiana. That city is also serviced by the Kansas City Southern route which extends southward from Shreveport.

Waterways. The major rivers of the region are also shipping lanes that link the cities of the region to other ports throughout the country and the world. These rivers -- the Neches, the Sabine and the Calcasieu -- are similar in several aspects. Before they reach the deep waters of the Gulf of Mexico, they pass through shallow coastal lakes. Much of the sediment carried by the rivers during seasonal rains is deposited in these lakes. As a result, in order to open the inland ports to ocean vessels, these rivers must be periodically dredged to maintain the shipping channels. The channels along the Neches and Calcasieu Rivers were cut through the land, abandoning the natural course of the rivers, to make the shipping routes shorter.

The Intracoastal Waterway crosses through this region east to west from Galveston Bay through Chambers County and the southern part of Jefferson County. It converges with the Port Arthur Canal and runs north and south along the western shore of Sabine Lake, then up the Sabine River to Orange. The waterway branches off from the Sabine River just north of the Calcasieu-Cameron Parish border and continues eastward across the Calcasieu River. The controlling depth of the waterway is 10 feet in the section from Galveston Bay to the Sabine River, limiting the use of this portion of the waterway to barges and small boats. The section from the Sabine River to the Calcasieu River has a controlling depth of 30 feet, allowing for the passage of larger vessels (Waterborne Commerce, 1975).

Airports. The four major airports of the region are the Beaumont Municipal, Jefferson County, Orange County, and Lake Charles Municipal airports. In addition, there are several small craft landing fields along the border area between Chambers County and the southern portion of Jefferson County, and one at Cameron, Louisiana.

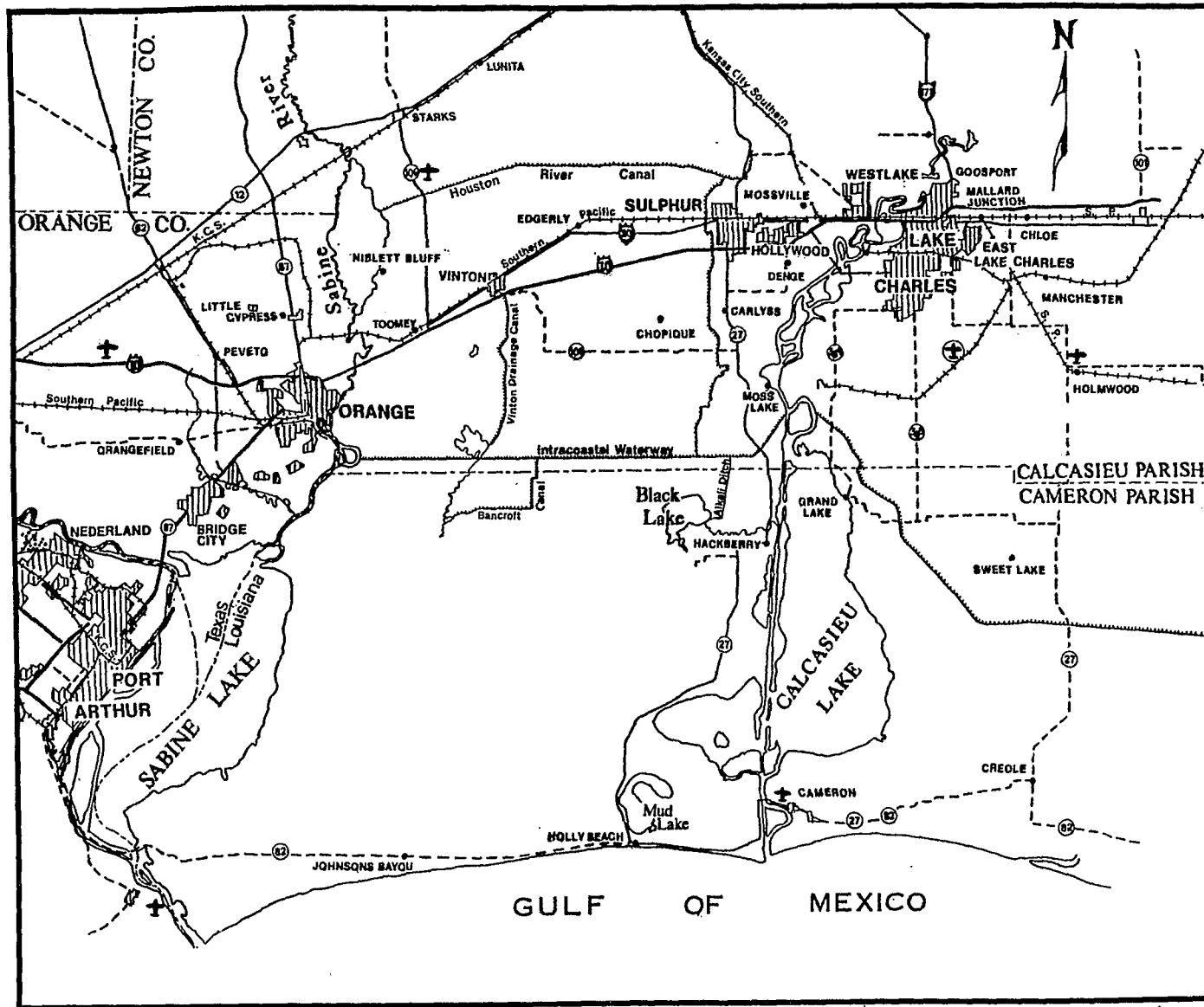

Figure B.2-32 Regional Transportation Systems

Pipelines

A huge network of pipelines is strung along the coastal area of Texas and Louisiana. There are three main types of pipelines, distinguished by what they carry. These are the crude oil pipelines, natural gas pipelines, and refined hydrocarbon product pipelines.

A portion of the crude oil pipeline system is shown in Figure B.2-33. Houston is a major center in the crude oil pipeline grid, as well as Sour Lake, which is near Beaumont, and the Nederland, Port Neches, and Port Arthur area. Pipelines connect the refineries and oil ports in these areas to other refineries, petrochemical centers, and oil fields in West Texas, Oklahoma, and Kansas. The Texoma pipeline carries oil to Oklahoma. Five major pipelines branch away from the Oklahoma center, bringing oil northeastward to Patoka, Illinois; Chicago; and Toledo, Ohio. The figure does not show all the pipelines, since this region is one of the three major cluster areas of crude oil pipelines.

The gas pipeline network is shown in Figure B.2-34. Louisiana is a major gas collection state, as evidenced by the pipeline system that goes offshore. There are far more gas pipelines in the nation than crude oil pipelines. Many of the gas lines shown in the figure travel up the Mississippi River Valley carrying the fuel to industries in the Midwest, the steel plants in Southwestern Pennsylvania, and the East Coast, as well as branching into communities to bring gas to private homes. The Transcontinental Gas pipeline can be seen on the figure, running north and south near the Texas-Louisiana border. The right-of-way of this pipeline would be used if the Vinton or Black Bayou site were used for the oil storage program. A new pipeline called "Topzi" is being planned for construction, and would run north and south parallel to the Transcontinental Gas pipeline and just east of it. As with the crude oil pipeline figure, not all gas pipelines in the region appear on this map.

The hydrocarbon product pipelines have a network similar to that for crude oil. The densest concentration of product pipelines lies from east to west between Houston and the Beaumont-Port Arthur area where about 12 pipelines run roughly parallel to each other, through this region.

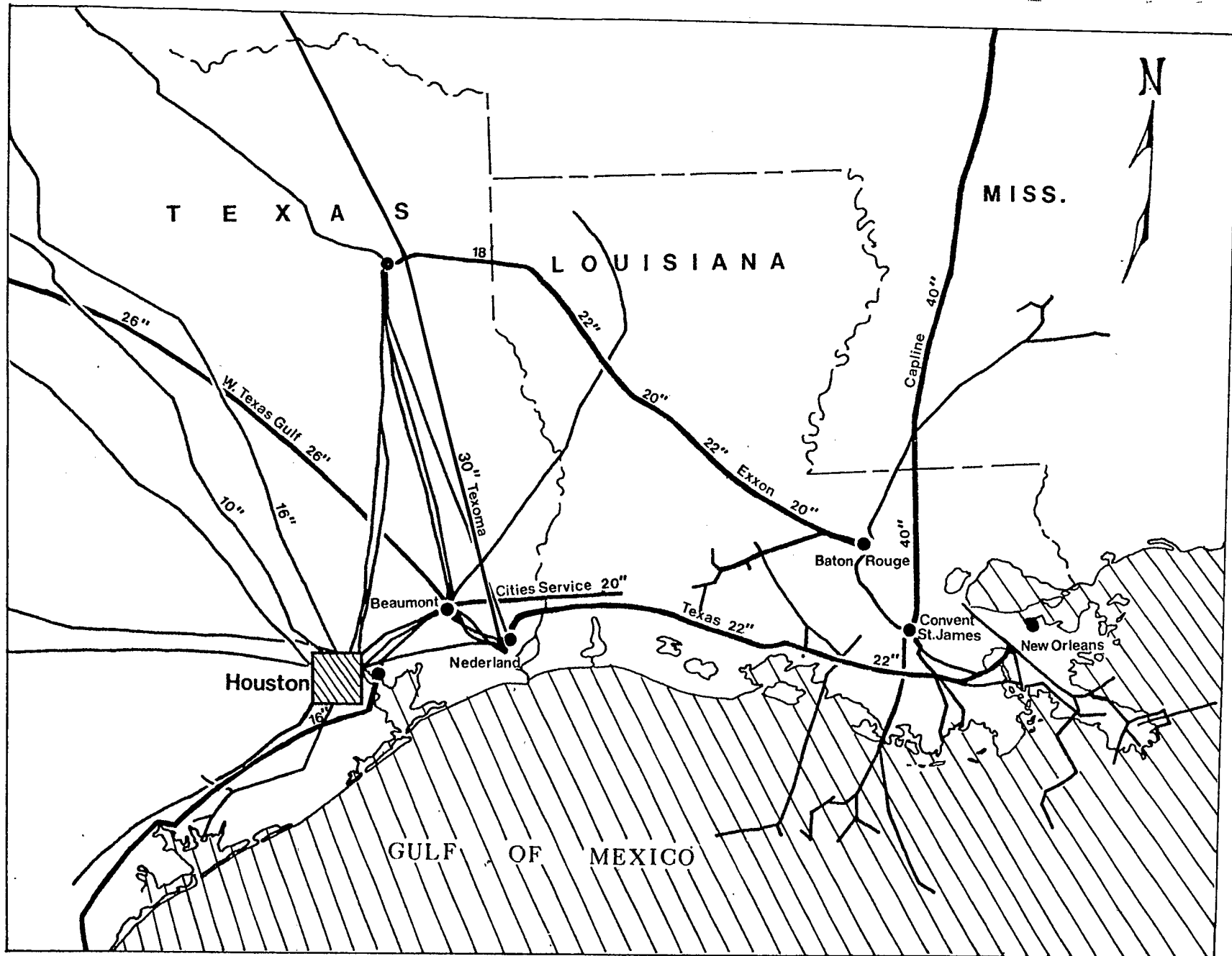

Figure B.2-33 Major Crude Oil Pipeline Routes

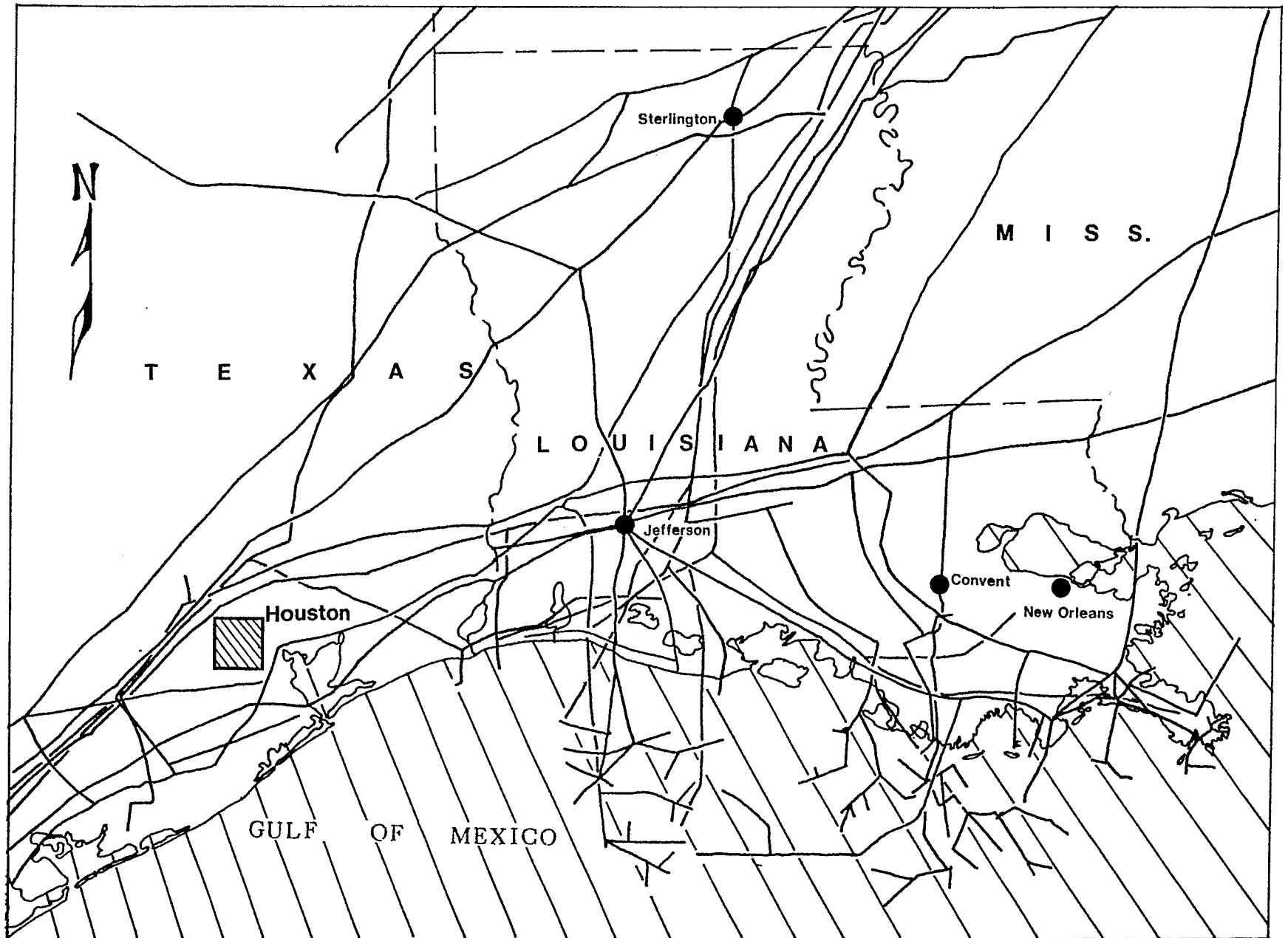

Figure B.2-34 Major Gas Pipeline Routes

B.2.8.5 Housing and Public Services

The number of year-round housing units, occupancy, and percentage of units vacant for sale or rent in the region, are shown in Table B.2-21. The total number of housing units available probably includes some which do not have all the standard plumbing facilities, and it can be assumed that the vacancy rates in these counties and parishes would be reduced if vacant housing units with substandard plumbing were subtracted from the total number of vacant units.

The median value of owner-occupied units in Cameron Parish is substantially below that of the state: \$8,800 compared to \$14,600.* A comparison of the percentages of increase in housing value between 1960 and 1970, shows that values are rising slightly faster in Cameron Parish than in the state. Also, the growth in the number of year-round housing units in Cameron Parish is 35.4 percent in that same time period, and is comparable to the 36.4 percent growth rate for the state.

The housing situation in Calcasieu Parish has reflected its population growth pattern. The number of year-round housing units increased by 62.5 percent between 1950 and 1960, but increased by only 4.6 percent between 1960 and 1970. The median value of housing in Calcasieu Parish is \$12,900 which is 88 percent of the median value of housing throughout the State.

While the number of housing units available for sale or rent in the counties and parishes is typically 3 to 5 percent, an examination of the availability of housing in the major cities of the region indicates that while the opportunities for purchasing a home are limited (homeowner vacancy rate is from 0.8 to 2.2), the cities would be able to accommodate some population expansion in rental units (see Table B.2-22).

Schools and Pupil Enrollment.

Within the region there are 228 elementary and high schools, with a total enrollment of about 108,000 pupils. Jefferson County has the largest school system, accounting for about 46 percent of the regional enrollment, Calcasieu Parish is second with 36 percent, Orange County has 16 percent, and Cameron Parish has 2 percent. Church affiliated schools contribute to the educational facilities of the region. About 7 percent of the pupils in elementary and high schools in Jefferson County are enrolled in church schools, and about 6 percent in Calcasieu Parish.

*Based on one-family houses on less than 10 acres and excluding mobile homes.

Table B.2-21. Housing Characteristics of the Region, by County and Parish

	<u>Calcasieu</u> ¹	<u>Cameron</u> ¹	<u>Orange</u> ²	<u>Jefferson</u> ²	<u>Chambers</u> ²
Year-round Housing Units	45,461	3,098	22,197	82,092	4,249
Occupied Dwelling Units	42,065	2,310	20,944	76,487	3,838
Owner-occupied	29,922	1,774	14,824	52,954	2,962
Renter-occupied	12,143	536	6,120	23,533	876
Lacking Some or All					
Plumbing Facilities	2,865	476	767	2,974	618
% Lacking Plumbing	6.3	15.3	3.5	3.6	14.5
Vacant for Sale or Rent	2,007	121	872	3,906	136
% Vacant for Sale or Rent	4.4	4.0	3.9	4.8	3.2

¹ Public Affairs Research Council of Louisiana, Inc., Statistical Profiles Based on U. S. Census of Housing, 1970.

² Source: U.S. Census of Housing, 1970.

Table B.2-22. Housing Characteristics of Major Cities of the Region

	<u>Lake Charles</u>	<u>Beaumont</u>	<u>Port Arthur</u>	<u>Orange</u>
Year-round Housing Units	24,893	40,103	20,078	8,183
Occupied Dwelling Units	23,073	37,027	18,455	7,529
% Owner-occupied	64.5	63.1	68.2	53.4
% Renter-occupied	35.5	36.9	31.8	46.6
% Lacking Some or All Plumbing Facilities	4.0	5.3	3.7	3.4
Vacancy Rate				
Homeowner	2.2	1.6	1.9	1.4
Rental	11.0	11.7	12.9	11.4
Median Value (owner)	\$13,800	\$11,600	\$ 9,600	\$11,600
Median Contract (renter)	\$. 62	\$. 64	\$. 55	\$. 60

Source: U. S. Census of Housing, 1970.

Health Care Facilities. The two parishes in the Louisiana side of the region are part of the Lake Charles Health Service Planning Region, which includes Beauregard and Jefferson Davis Parishes as well as Cameron and Calcasieu. Medical services for the planning region are concentrated in the Lake Charles metropolitan area.

There are three hospitals in Lake Charles: Lake Charles Charity Hospital with 110 beds; Lake Charles Memorial Hospital with 227 beds; and St. Patrick Hospital of Lake Charles with 246 beds (American Hospital Association, 1975). An independently-owned ambulance service operates out of Lake Charles.

The West Calcasieu-Cameron Hospital, located in the city of Sulphur, has 111 beds and a 262-member staff. An ambulance service is affiliated with this hospital.

A small hospital is available in the town of Cameron. This is the South Cameron Memorial Hospital which has 27 beds and a staff of 49 personnel.

The Texas portion of the region has more numerous medical facilities. There are three general medical and surgical hospitals in Beaumont (in addition to three specialized neurological hospitals). These include the Baptist Hospital of Southeast Texas with 373 beds, the Douglas Hospital Clinic with 15 beds, and the St. Elizabeth Hospital with 406 beds.

In addition, there are two hospitals in Port Arthur, the Park Place Hospital (180 beds), and the St. Mary Hospital (229 beds). The Orange Memorial Hospital has 205 beds, and services Orange County. The Mid-Jefferson County Hospital at Nederland has a 1,200-bed capacity, and the small Medical Center at Winnie in Chambers County has 60 beds.

Helicopter ambulance services operating out of Lafayette, Louisiana and Houston, Texas provide emergency rescue services to isolated parts of the Coastal region as well as to offshore oil and gas drilling operations.

B.2.8.6 Economy

The region lies principally within two BEA areas*. Calcasieu and Cameron Parishes lie within the Lake Charles area, while Orange and Jefferson Counties are included in the Beaumont-Port Arthur-Orange BEA. A BEA area is defined as a functional labor market, meaning, there is a minimum of commuting across area boundaries to place of work. Since the BEA area is a multi-county unit, the parishes and counties under consideration form only part of a larger area. Economic and employment data for these areas are given in Table B.2-23.

Even though the two areas are adjacent, a careful examination of the table reveals several differences in the respective economies. First, for the Lake Charles area, both actual and projected sources of income are distributed fairly evenly over industry categories, with government providing the largest amount. But this is not the case for the Beaumont area, since manufacturing accounted for approximately 42% of total earnings in 1970 and is projected to maintain this dominating position over the decade. The two occupations accounting for most of the manufacturing earnings in the Beaumont area in 1970, were petroleum refining and chemicals and allied products, generating approximately 40% and 23%, respectively, of the total earnings from this sector. In the Lake Charles area, petroleum refining accounts for 28% of manufacturing earnings, while the comparable figure for chemicals and allied products is 23%. The dependence upon petroleum and petrochemicals is great in both regions, but the Beaumont area economy would show the greatest effects of any changes in these industries.

Texas - Jefferson and Orange Counties

The Big Hill site for a potential SPR facility lies within Jefferson County; the potential pipeline route from Sun Terminal to various sites in Louisiana, passes through Orange County. In Table B.2-24, the total payroll and sources of income are presented for each county, with the patterns in each county similar to those observed by the BEA area, i.e., a major source of total payroll is the manufacturing sector.

*Areas established by the Bureau of Economic Analysis, U. S. Department of Commerce.

Table B.2-23. EMPLOYMENT AND INCOME OF THE REGIONAL BEA AREAS

	<u>Louisiana</u>		<u>Texas</u>	
	<u>1970</u>	<u>1980</u>	<u>1970</u>	<u>1980</u>
Population, midyear	750,632	695,800	396,723	432,800
Per capita income relative U.S.	.71	.72	.89	.89
Employment/Population ratio	.33	.36	.35	.39
Earnings per worker relative U.S.	.82	.84	1.01	1.01

In thousands of 1969 dollars

Total personal income	1,849,029	2,407,000	1,231,945	1,832,800
Total earnings	1,426,247	1,834,100	1,006,132	1,479,700

Sources of Income*

Agriculture, forestries, fisheries	119,200 (8.4)	141,300 (7.7)	(2.0).	5,500 (0.4)
Mining	141,049 (9.9)	171,200 (9.3)		10,500 (0.7)
Contract Construction	113,950 (8.0)	129,900 (7.1)	84,602 (8.4)	102,200 (6.9)
Manufacturing	199,552 (13.2)	295,900 (16.1)	424,657 (42.2)	625,800 (42.3)
Trans., comm., public utilities	99,976 (7.0)	134,600 (7.3)	87,942 (8.7)	115,200 (7.8)
Wholesale ' Retail trade	211,657 (14.8)	266,000 (14.5)	133,040 (13.2)	192,000 (13.0)
Fin., Ins., Real Estate	33,592 (2.4)	51,000 (2.8)	30,073 (3.0)	53,700 (3.6)
Services	159,355 (11.2)	238,900 (13.0)	121,143 (12.0)	211,000 (14.3)
Government	347,919 (24.4)	404,900 (22.1)	105,314 (10.5)	163,400 (11.0)

Source: Obers Projections done for the Water Resource Council.

*Numbers in parenthesis are percent of total earnings.

Table B.2-24 Payroll and Sources of Earnings for Texas Counties

	Jefferson	Orange
Total Payroll(1000)	777,894*	158,744*
Sources of Earnings		
Agriculture, forestries, fisheries	814(0.1)**	88(0.06)**
Mining	7,053(0.9)	889(0.6)
Contract Construction	68,564(8.8)	11,673(7.4)
Manufacturing	389,479(50.1)	109,918(69.2)
Trans., comm., and public utilities	67,041(8.6)	4,968(3.1)
Wholesale and Retail Trade	136,395(17.5)	17,338(10.9)
Finance, ins., and real estate	23,220(3.0)	3,437(2.2)
Services	80,891(10.4)	9,743(6.1)

*Total includes non-classifiable establishments

**Per cent of total payroll

Source: U.S. Department of Commerce, County Business Patterns, 1974.

In Jefferson County, chemicals and allied products and petroleum and coal products accounted for the largest portions of the total manufacturing payroll, 22% and 52%, respectively. An examination of the manufacturing sector in Orange County shows payrolls from chemicals and allied products accounting for 58% of total payrolls in this sector, while payrolls associated with petroleum products are not listed. These numbers indicate the relative importance of refining operations in Jefferson County and petrochemicals in Orange County. Other manufacturing in the region includes synthetic rubber, plastics, paper and sawmills, ship barge and offshore drilling rig construction. Various agricultural products in the region include rice, soybeans and timber. Construction activity has been supported by the local deposits of sand, gravel, and shell (South East Texas Regional Planning Commission).

In 1970, the total civilian labor force (16 years and older) for Jefferson and Orange Counties was 93,914 and 25,667, respectively. Unemployment for Jefferson County was about 4% and about 5% in Orange (U.S. Commerce, 1972). Estimates of the labor force and annual average unemployment rates for 1975 are as follows: (1) Jefferson - 98,976 with 7.1% unemployment, and (2) Orange - 29,955 with 7.9% unemployment (Texas Employment Commission, 1977). Table B.2-25 shows occupational breakdowns by total employment.

Estimates for 1974 show median household effective buying power to be \$11,500 in Jefferson County and \$13,632 in Orange; the percentage of households with effective buying power exceeding \$15,000 in the same year was 32.3% and 42.4%, respectively (Sales Management, The Marketing Magazine, 1975).

The total number of farms decreased from 1964-1969 in both counties, by 8.1% in Jefferson and 15% in Orange, along with total acreage in farm production. In 1970, the farm population totaled 795 people - less than 1% of the total population of the county - representing a 1.1% decline from 1960. In 1969, farms in Jefferson County under 10 acres numbered 38 while those exceeding 1,000 acres number 84. In 1969 about 47% of the farm labor force worked more than 100 days off the farm. In Orange County, the farm population in 1970 totaled 311, a drop of 31.8% from 1960 and approximately 0.4% of the 1970 population of the county. Farms under 10 acres and those exceeding 1,000 in 1969 were almost equivalent, 19 and 18, respectively. In the same year, 63.4% of the farm population was working 100 or more days off the farm. In

Table B.2-25 Labor Force Distribution in Texas Counties

	<u>Jefferson</u>	<u>Orange</u>
Agriculture, forestries, fisheries	0.2	0.1
Mining	0.7	0.6
Contract Construction	0.8	7.1
Manufacturing	35.2	52.3
Trans., comm., public utilities	8.0	4.0
Wholesale & Retail trade	27.1	20.3
Fin., Ins., Real Estate	3.9	3.2
Services	16.5	11.5

Source: U.S. Department of Commerce, County Business
Patterns, 1974.

Jefferson County the mean value of a farm on a per acre basis was \$253 in 1969, while the comparable figure for Orange County was \$390 (U. S. Commerce, 1972).

Total bank deposits in Jefferson County for April 1975 were \$767,810,478, representing approximately a 12% increase over the year from April 1974. The loan-to-deposit ratio for Jefferson County banks was 56%. In Orange County, total deposits were \$106,778,427 in April 1975, an 11% increase on the year. The loan-to-deposit ratio in Orange County was 49% (South East Texas Regional Planning Commission).

Table B.2-26 presents information on county government finances for Jefferson and Orange Counties. In both cases, the major sources of revenue for the counties are property taxes. An examination of county expenditures shows both counties heavily involved in the county school system, with other expenditure categories far down the list in importance.

Louisiana - Calcasieu and Cameron Parishes

The potential sites for the SPR facility of Black Bayou and West Hackberry are in Cameron Parish, while the Vinton site is located in Calcasieu Parish. Table B.2-27 presents the quarterly taxable payrolls for these two counties for 1973. For Calcasieu Parish, the numbers indicate a fairly diversified economy with the manufacturing sector accounting for 40% of the taxable payroll, about equivalent to the relative position of the manufacturing sector found in the BEA area. On the other hand, Cameron Parish is heavily dependent upon oil and gas extraction (listed under mining in Table B.2-27). In the first quarter of 1973, crude oil and natural gas accounted for 8.7% of the taxable payrolls for this sector, while natural gas liquids and oil and gas field services accounted for 12.1% and 79.2%, respectively. This shows most of the taxable payrolls in the community (55.6% of the total) are derived from worker's servicing or installing oil and gas equipment. Also, approximately 50% of the labor force report taxable incomes in 1973 work in this occupation. The principal crops in the area are rice and soybeans, with other products including sorghum, wheat, and hay.

In 1970, the total civilian labor force (16 years and older) was 2,734 in Cameron Parish, and 50,545 in Calcasieu, with unemployment rates of 4.9% and 5.7%

Table B.2-26 Texas County Government Finances, 1971-1972

	<u>Jefferson</u>	<u>Orange</u>
General Revenue, excluding interlocal (1000)	94,010	24,120
Intergovernmental State	24,618 (26.2) *	8,086 (33.5) *
	20,987	7,724
Local Sources	69,392 (73.8) *	16,033 (66.5) *
Taxes	53,505 (77.1) **	12,718 (79.3) **
Property	48,115 (69.3) **	11,618 (72.5) **
Other	5,389	1,100
Charges to misc.	15,888	3,316
 Direct General Expenditure	 91,751	 22,543
Education	46,693 (50.9) ***	15,150 (67.2) ***
Highways	5,362 (5.8)	1,016 (4.5)
Police Protection	5,566 (6.1)	859 (3.8)
Interest on General Debt	5,019 (5.5)	1,460 (6.5)

*Percent of total revenues.

**Percent of revenue from local sources.

***Percent of total expenditures (percentages will not sum to one since only the most important are listed).

Source: U.S. Department of Commerce, Census of Governments

Table B.2-27 Payroll and Sources of Earnings for Louisiana Parishes

	<u>Calcasieu</u>	<u>Cameron</u>
Total Payroll(1000)	66,856*	5,079*
	Sources of Earnings	
Agriculture, forestries, fisheries	105(0.2)**	62(1.2)*:
Mining	3,343(5.0)	3,570(70.3)
Contract Construction	8,913(13.3)	11(0.2)
Manufacturing	26,746(40.0)	486(9.6)
Trans., comm., and public utilities	2,556(3.8)	394(7.8)
Wholesale and Retail Trade	9,852(14.7)	227(4.5)
Finance, ins., and real estate	2,929(4.4)	54(1.1)
Services	6,619(9.9)	261(5.1)

* Total includes non-classifiable establishments

** Per cent of total payroll

Source: U.S. Department of Commerce, County Business Patterns, 1973.

respectively, (U. S. Commerce, 1972). Table B.2-28 shows the percentage of total workers in each occupational category during the mid-March pay period in 1973. Projections obtained from the Imperial Calcasieu Regional Planning Commission show an unemployment rate in 1975 of 8.8% in Cameron Parish and 6.1% in Calcasieu.

Estimates of effective buying income in 1972 were \$486,684,000 in Calcasieu Parish and \$26,516,000 in Cameron (Louisiana Statistical Abstract, 1974). The percentage of households with income exceeding \$15,000 were 15.5% and 9.7% in Calcasieu and Cameron Parishes, respectively.

In 1969, there were 739 farms in Calcasieu Parish with an average size of 546 acres. Within the parish, 57% of the land is used for agriculture. For the same year, the comparable figures for Cameron Parish are 423 farms, 679 acres average size, and 31% of the land used (Louisiana Statistical Abstract, 1974).

The farm population for Calcasieu Parish in 1970 totaled 1,171, a 36% decrease from 1960 and less than 1% of the total parish population. Farms greater than 1,000 acres were twice those under 10 acres in 1969, 82 and 40, respectively. For this same year about 51% of the total farm population worked more than 100 days off the farm. In Cameron Parish the farm population in 1970 was 894, about 11% of the total population, with the farm population figure representing a 35% increase from 1960. The number of farms less than 10 acres numbered 45. During the year 1969 about 50% of the total farm population worked 100 days or more off the farm (U. S. Commerce, 1972).

B.2.8.7 Government

Certain jurisdictional concerns of local governments in the region would have a bearing on the proposed oil storage project. The state responsibilities include: control of air emissions, discharges into surface and ground waters, preservation of historical and cultural resources, and construction on state-owned lands.

Local parish and county governments also have jurisdictional interests in the proposed work. Use of the rights-of-way of parish and county roads for pipelines, and the provision of building permits, are two examples of this local involvement that are common to all the affected parishes and counties. In addition, Cameron Parish, which lies in a hurricane-prone area, has general authority to permit or withhold permission for construction on flood plains and in flood hazard areas.

The parishes and counties of this region are further divided into drainage districts. These district commissioners have responsibility for the maintenance of the drainage channel systems that protect agricultural and urban lands, and would have a jurisdictional interest in any pipelines planned to cross under these channels.

Table B.2-28 Labor Force Distribution in Louisiana Parishes

	<u>Cameron</u>	<u>Calcasieu</u>
Total Employment	2,636	35,246
Agricultural Services, Forestry, Fisheries	28 (1.1)**	78 (0.2)**
Mining	1,599 (60.7)	1,386 (3.9)
Contract Construction	18 (0.7)	3,907 (11.1)
Manufacturing	308 (11.7)	9,908 (28.1)
Trans., Comm., Public Utilities	190 (7.2)	2,556 (7.3)
Wholesale & Retail Trade	206 (7.8)	9,853 (28.0)
Fin., Ins., Real Estate	42 (1.6)	1,763 (5.0)
Services	212 (8.0)	5,639 (16.0)

**Percent of total employment.

Source: U.S. Department of Commerce, County Business Patterns, 1973.

B.3 SITE SPECIFIC ENVIRONMENT

B.3.1 West Hackberry Salt Dome

B.3.1.1 Land Features

B.3.1.1.1 Geomorphology

The West Hackberry Salt Dome is located in north central Cameron Parish, Louisiana, 20 miles southwest of Lake Charles City, 16 miles north of the Gulf of Mexico and four miles south of the ICW.

West Hackberry lies near the western end of the Hackberry Ridge. This ridge extends 7 miles from the western shore of Calcasieu Lake to Vincent Island. The Hackberry Ridge was probably formed as a result of vertical displacement of sediments by the rising salt. Black Lake lies northwest of the dome and the ridge. Black Lake Bayou meanders along the northern boundary of the ridge and flows into Calcasieu Lake. Extensive marsh with a Gulfward slope of only 1 to 3 feet per mile surrounds the dome and ridge to the north, west, and south. Alkali Ditch extends from near the center of the dome northeast to the ICW. It is 4.2 miles long and was constructed to accommodate barges with 9 foot draft.

The highest point of the Hackberry Ridge overlies the center of the West Hackberry dome, where the elevation is 23.5 feet above sea level.

The streams which cross the Hackberry ridge do not appear to be genetically related to the present marsh drainage system, rather they are large enough that they may be ancient distributaries of the Sabine or Mississippi Pleistocene river deltas (Howe, et al., 1938).

The surface area within the 2,000 foot depth contour of the salt stock is about 1,750 acres while the area enclosed by the 3,000 foot salt depth contour is 2,600 acres. Of the 1,750 acres inside the 2,000 foot contour approximately 850 acres are above water.

B.3.1.1.2 Geologic Structure

In plan view the West Hackberry salt dome is an elliptical piercement structure, having a broad nearly flat top at an average depth of 2,000 feet below sea level. The slope of the sides of the dome are from slightly less than 60° to steeper than 75° on the north side. On the southeast perimeter of the salt there is a significant re-entrant feature, often referred to as an overhang. The dome is part

of a larger salt mass which includes the East Hackberry salt dome (see Figure B.3-1). The overall length of this salt mass is more than 9 miles, with its width exceeding 2 miles. The long axis of the salt mass trends N73°E.

No detailed information on the distribution and configuration of subsurface faulting was found. However, this dome appears to be typical of most Gulf Coast piercement domes (Halbouty, 1967); thus the characteristic normal, radial, and concentric faults probably exist in the sediments around the dome. The displacement along these faults generally increases with depth.

An analysis of the records of more than 40 drill holes shows that a cap rock covers the entire salt mass above the 3,000 foot depth contour. The cap rock reaches a maximum thickness of 525 feet in the southwest quarter of Section 21 (Figure B.3-1) and gradually thins in all directions. A contour structural map and an isopach map of the cap rock appear as Figures B.3-2 and B.3-3. Cap rock depth ranges from less than 1,500 feet in the southwest quarter of the section to over 4,000 feet on the north and south perimeter. Geologic cross section A-A' and B-B', constructed from electric log data, (Figures B.3-4 and B.3-5), show the lateral extent of the cap rock, the local sedimentary sequences and the relationship of these sediments to the salt structure.

The cap rock is intensely fractured, faulted, and brecciated due to the upward pressures exerted by the rising salt stock. During periods when the salt is stable or not rising as fast as the dissolution of the salt is occurring, the cap rock may be partially unsupported and fall with adjustments occurring along new or preexisting fault planes. This mechanism may be the cause of the slight topographic low above the east side of the West Hackberry dome. The faulting and fracturing in the cap rock results in high permeability, but this is of no consequence with respect to the integrity of the proposed oil storage caverns.

B.3.1.1.3 Stratigraphy

Detailed stratigraphic data for the immediate vicinity of the Hackberry dome was not found. However, the sequence of the formations deposited in the coastal basin is generally consistent throughout, therefore, the description of formations at Vinton Salt Dome can apply to the Hackberry stratigraphy except for thickness variations and local effects of vertical displacement by the rising salt (see Section B.3.3.1.3). Briefly however, the sequence of sediments at West Hackberry is from the surface down: Beaumont, Clay, Lafayette Gravel, Fleming Clay, Oligiocene Formation (sands and sand shales) and Jackson Shale.

B.3-3

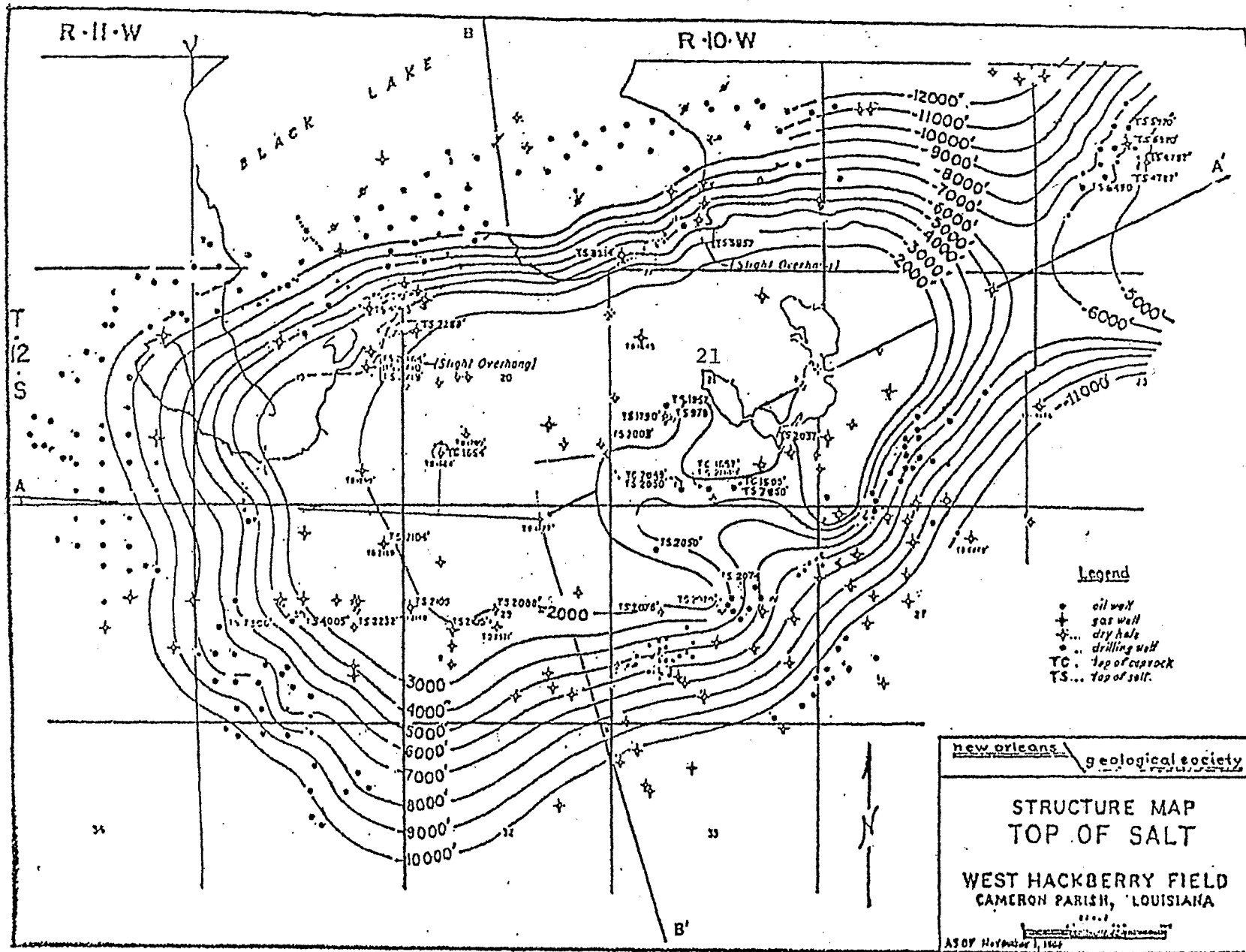

Figure B.3-1 Structure Map - West Hackberry Field

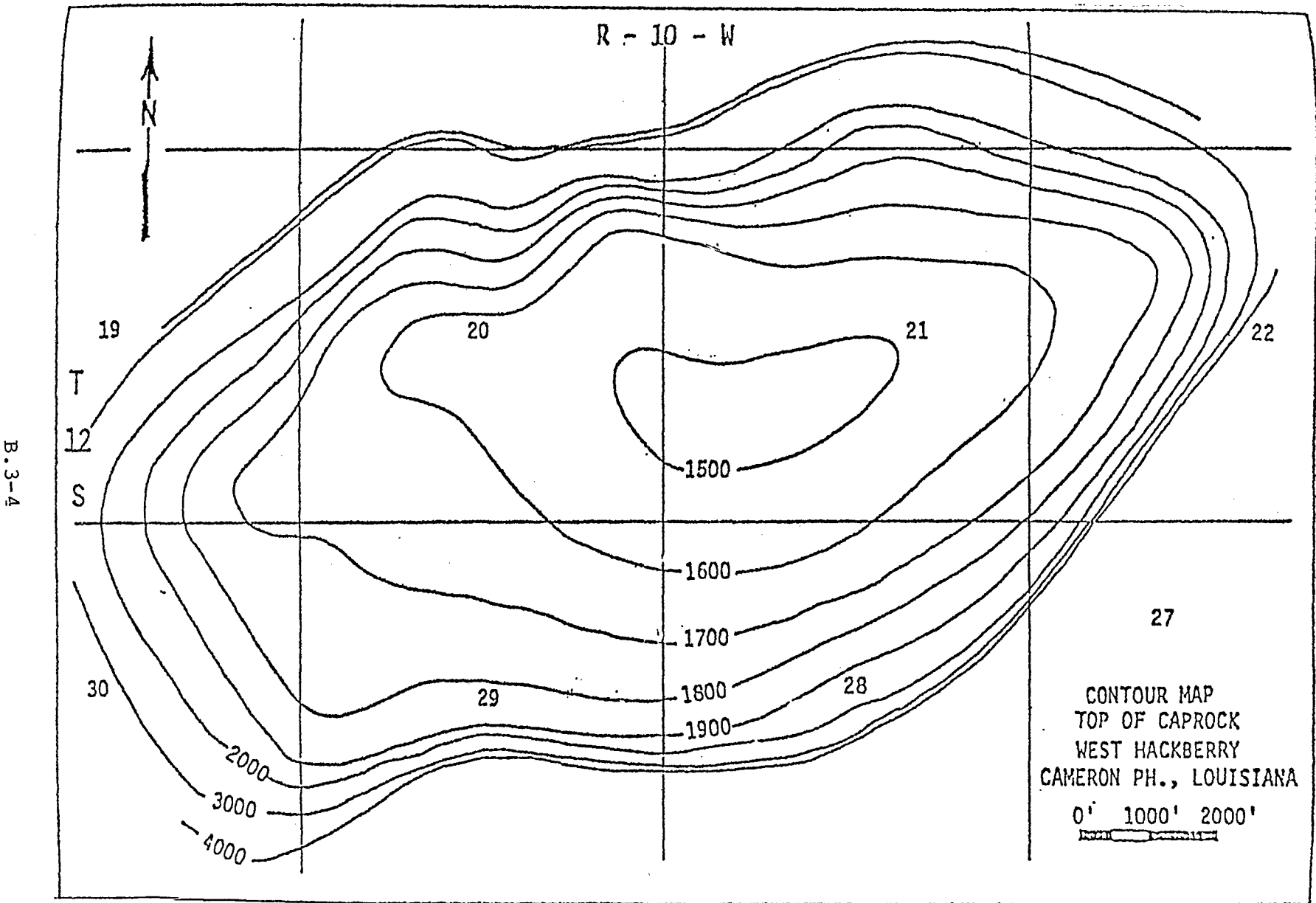

Figure B.3-2. Contour Map - Top of Caprock, West Hackberry

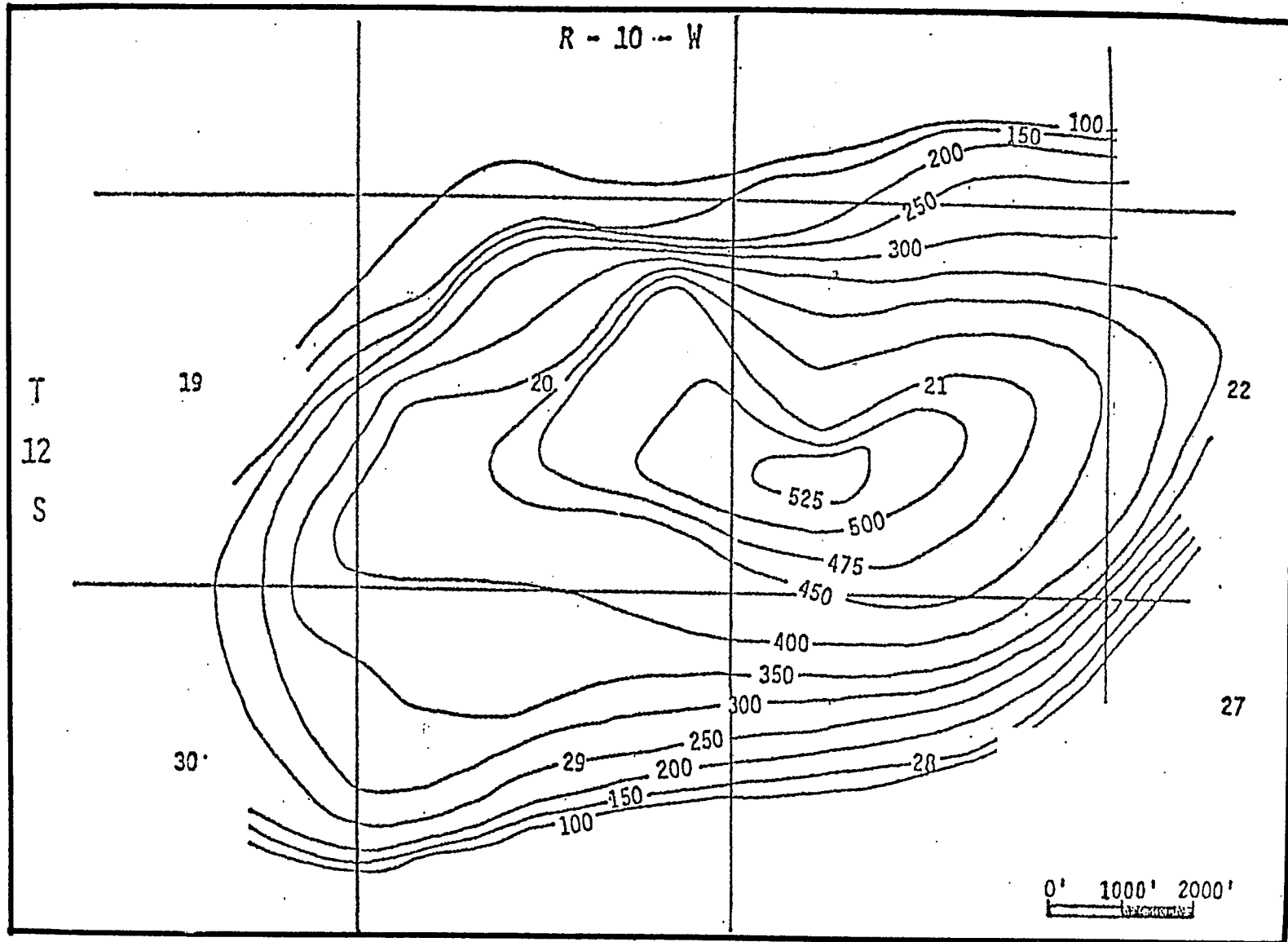

Figure B.3-3. Isopach Map of Thickness of Caprock West Hackberry, Cameron Parish, La.

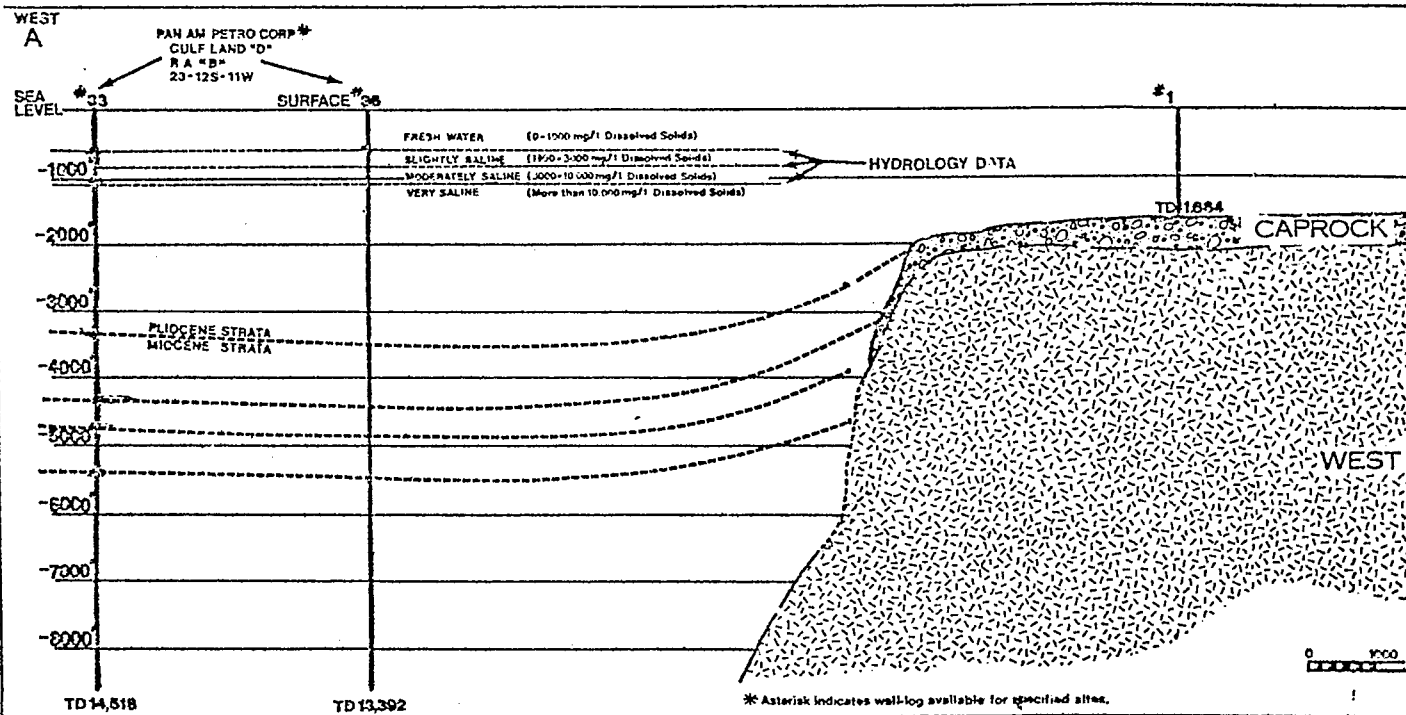

Figure B.3-4. Geological East/West Cross Section West Hackberry Dome A-A'

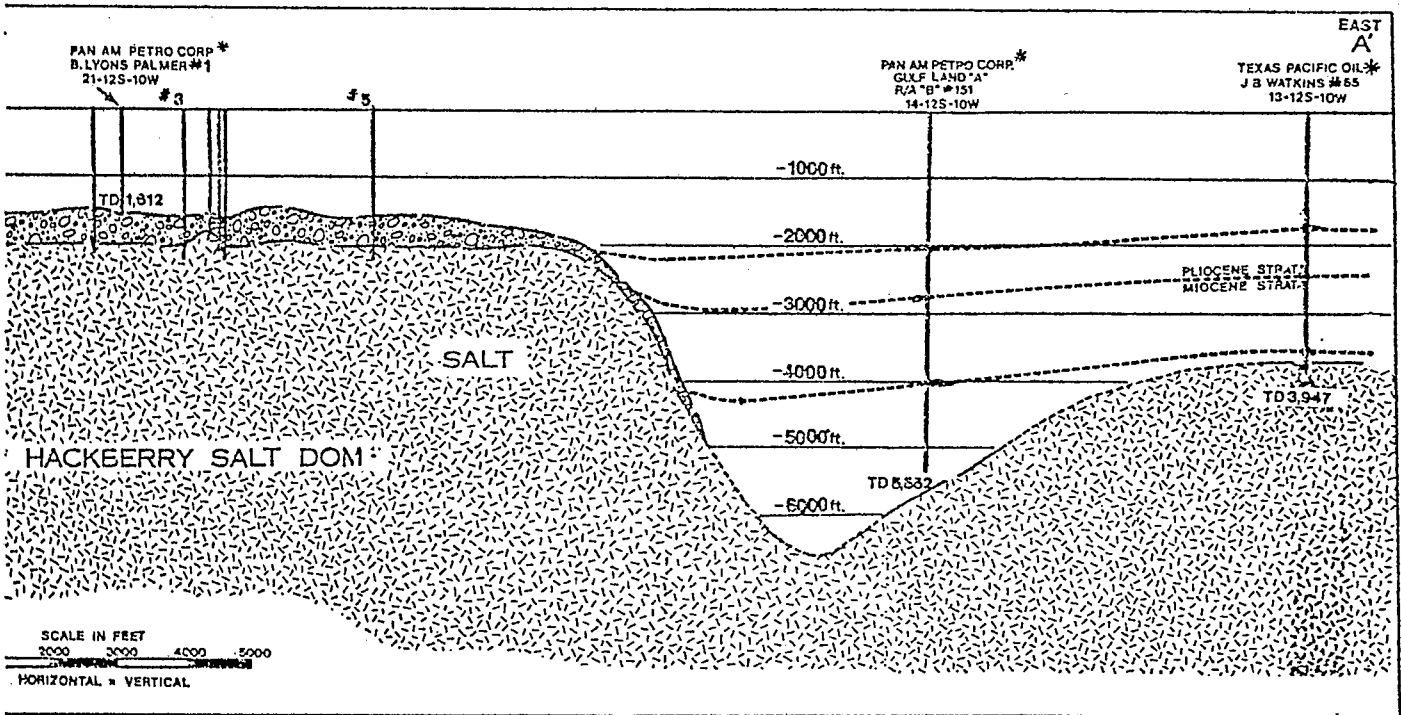

Figure B.3-4 Geological East/West Cross Section
West Hackberry Dome A-A' (Continued)

B.3-8

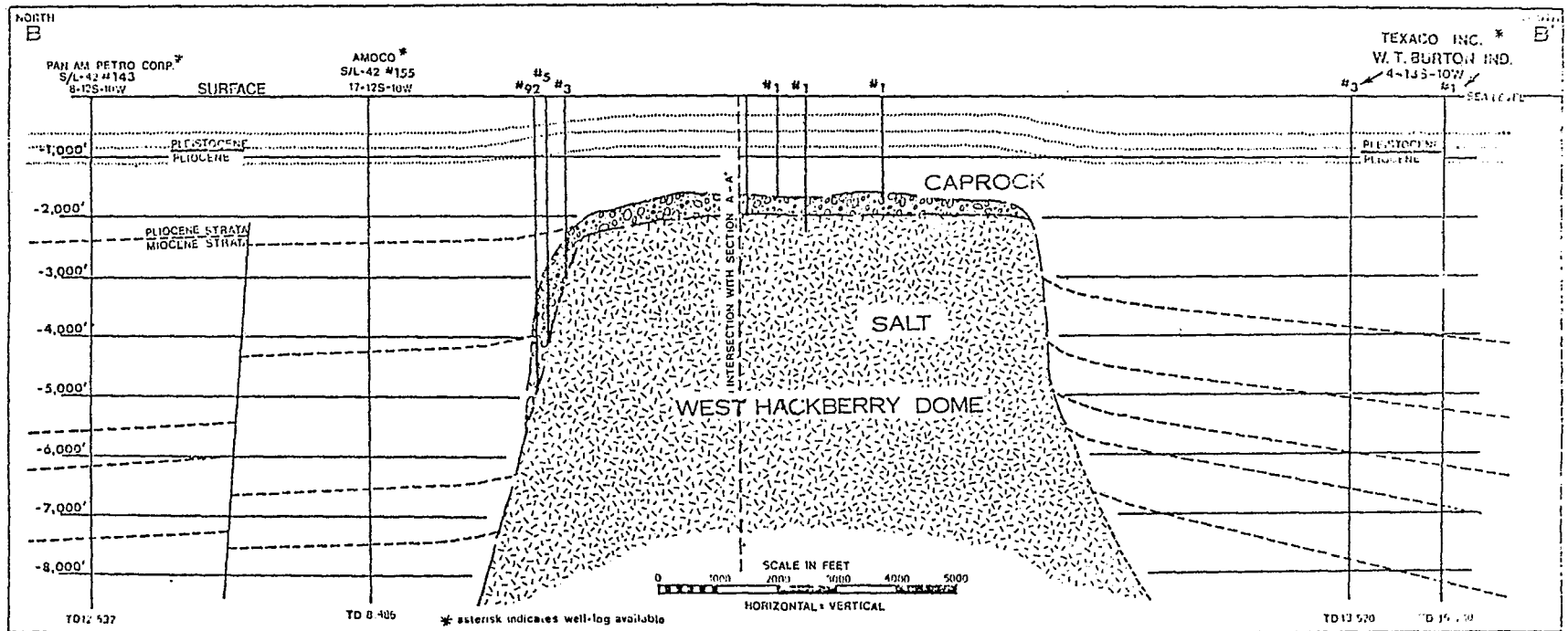

Figure B.3-5. Geological Cross Section, West Hackberry Dome B-B'

B.3.1.1.4 Soil Characteristics

The soils at the West Hackberry site (Figure B.3-6) are nearly level silty soils with clayey and silty subsoils. They are referred to as the Crowley-Morey-Mowata Association.

The poorly to somewhat poorly drained Crowley soils on the low ridges make up about 45 percent of the association. They have a very dark grayish-brown silt loam surface and a gray silty clay subsoil mottled with red and brown. The poorly drained Morey soils at the low elevations make up about 25 percent of the association. They have a very dark silt loam surface and a gray silty clay loam subsoil mottled with brown. The poorly drained Mowata soils at the low elevations make up about 20 percent of the association. They have a dark gray silt loam surface and a gray heavy silty clay loam subsoil mottled with brown. Beaumont soils make up most of the remaining 10 percent of the association, (USDA, 1971).

Harris soils, moderately saline phase, at the highest elevations and adjacent to ridges make up about 50 percent of the association. They have a very dark gray clay surface and a firm gray clay subsoil. Salt water marsh at the lowest elevations make up about 45 percent of the association. They have a soft organic and mineral mud surface layer 18 to 50 inches thick and a gray clay subsoil. Ridges of Harris, Cheniere Variant and Harris, sandy substratum variant soils, and spoil banks make up most of the remaining 5 percent of the association, (USDA, 1971).

The brine disposal pipeline route crosses areas of Harris soil but in addition crosses Morey-Beaumont soils and borders Harris Chenier Variant - Palm Beach Association.

The Morey soils at the higher elevations make up about 70 percent of the association. They have a very dark gray silt loam surface and a gray silty clay loam subsoil mottled with brown. The Beaumont soils at the slightly lower elevations make up about 15 percent of the association. They have a dary gray clay

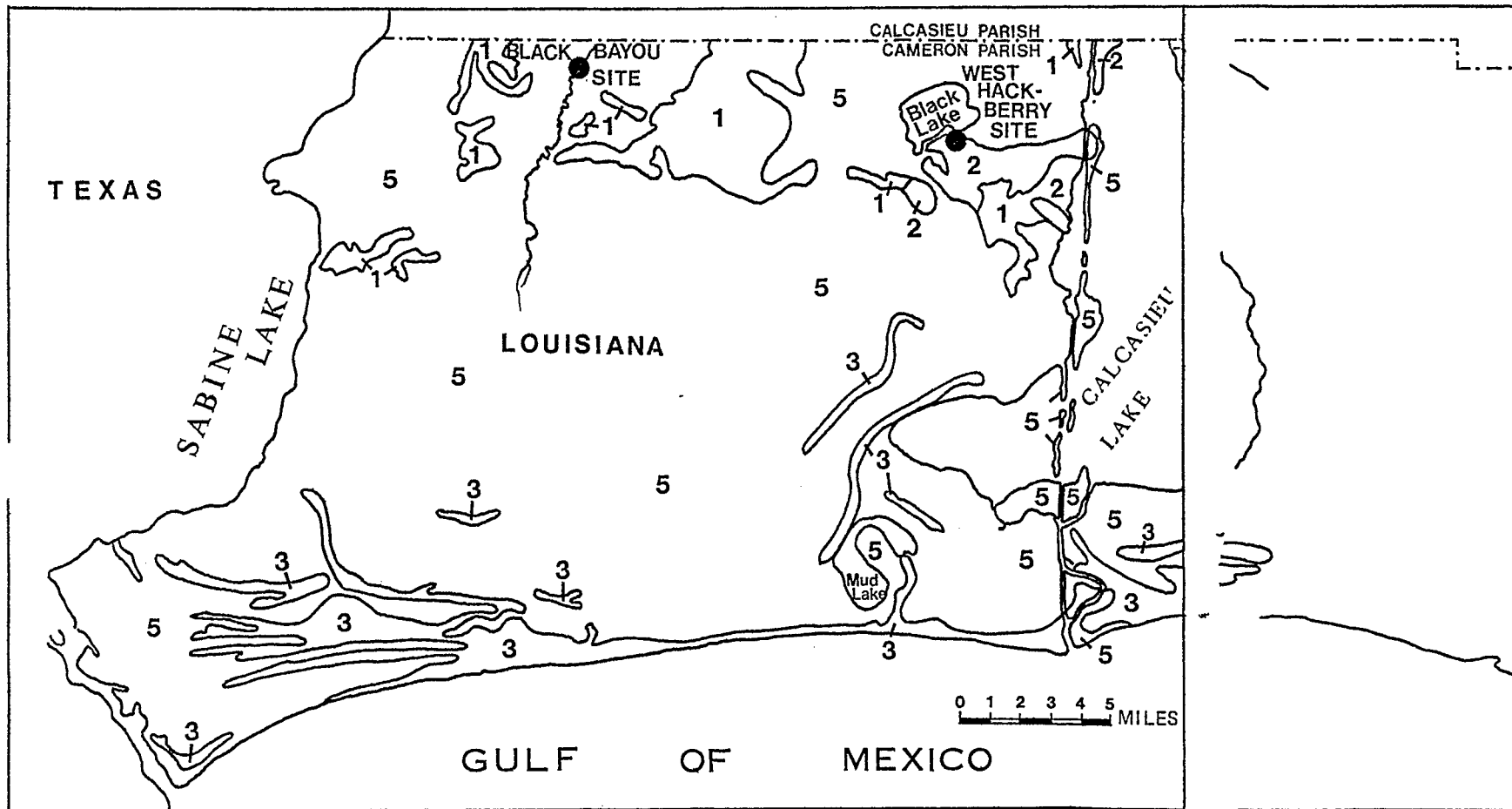

Figure B.3-6 Soil Distribution Map for Western Cameron Parish, Louisiana in the Vicinity of West Hackberry

- 1 Morey Beaumont Association - nearly level clayey and silty soils.
- 2 Crowley-Morey-Morwata Association - nearly level silty soils with clayey and silty subsoils.
- 3 Harris, Cheniere Variant - Palm Beach Association - clayey and sandy soils on low narrow ridges.
- 5 Harris - Salt Water Marsh Association - mineral and organic salt water marshland.

surface and a gray clay subsoil mottled with brown. Crowley, Mowata, and Harris soils make up most of the remaining 15 percent of the association, (USDA, 1971).

The poorly drained Harris, cheniere phase soils at low elevations make up about 60 percent of the association. They have a very dark gray surface and a gray sandy or clayey subsoil. The excessively drained Palm Beach soils at the higher elevations make up about 20 percent of the association. They have a dark brown sandy surface and a brown sandy subsoil that generally contains many fragments of sea shell. Made Land, Harris, sandy subsoil phase, and Harris, saline phase soils make up most of the remaining 20 percent of the association, (USDA, 1971).

The east end of the Hackberry Ridge on the shore of Lake Calcasieu forms a 10 foot cliff. Old, well-developed soil, subsoil, and rock are exposed. The subsoil contains iron and manganese nodules (Howe et al., 1938) which due to erosion of the ridge are forming a beach at the toe. Howe et al., (1938) state that the soil-subsoil profile is Pleistocene deltaic material and is older than the surface of the surrounding marsh.

B.3.1.1.5 Mineral Resources

Oil in the West Hackberry salt dome area was discovered by surface seeps of oil and gas in 1902. Oil was first commercially produced from the dome area in 1928 by the Cameron Oil Company. Initial production is reported to have been from Cameron Oil Company's Duhon No. 2 well in 1928. Louisiana State Conservation Department records show that oil or gas is, or has been produced from at least 15 different horizons as shallow as 3,920 feet and as deep as 9,813 feet. Oil bearing production zones are found completely around the perimeter of the dome. Interpretation of the salt structure indicates that the oil production occurs primarily from Miocene age sand formations faulted or pinched out against the sides of the salt stock. No known oil or gas production is located over the top of the dome in the area proposed for the solution mined storage cavern facility.

The first attempt at mineral mining of the dome was a sulfur exploration program conducted by the Freeport Sulphur Company in the late 1920s. Several holes were drilled into the cap rock

and salt to explore the potential for sulfur mining. No information regarding the results of this drilling program is available, and it appears that the dome was never mined for sulfur.

Olin Chemical Company is using portions of the West Hackberry salt dome for brine production and Cities Service Oil Company is using several caverns for subsurface storage of liquid petroleum gas. These operations represent only a partial development of the dome. The total acreage of the dome controlled by the Olin operation is 500 acres. Cities Service Oil Company has developed a total of nine caverns on 80 acres. Five of these nine caverns have been selected for use by the Strategic Petroleum Reserve Program. A description of these caverns and a discussion of cavern stability appears in Appendices H and I respectively of the Final Environmental Impact Statement for West Hackberry Salt Dome, FES 76/77-4 (FEA, 1977a).

B.3.1.2 Water Environment

The West Hackberry salt dome is located in Hydrologic Unit 9 of southwestern Louisiana within the estuarine part of the Calcasieu River Basin (Perret et al, 1971). The location of Hydrologic Unit 9 is indicated in Figure B.3-7 while the Calcasieu River basin is presented in Figure B.3-8. The northwestern rim of the dome lies beneath Black Lake, with the remaining portion covered by dry pasture land. To the south and west are marshes. Surface water in the general area is brackish with a salinity of 5 to 10 ppt, due to salt water intrusion (a major problem in this section of Louisiana). Surface levels in the region are underlaid by clays which are nearly impervious to water passage (Chabreck, 1972). While the annual rainfall appears plentiful, the area generally experiences a moisture shortage for vegetation during the growing season (from February through November).

The surface water system, which is described in Section B.3.1.2.1, represents the proposed source of leaching/displacement water as well as the primary site for brine disposal. The subsurface water system, which is discussed in Section B.3.1.2.2, constitutes an alternative source for water.

B.3.1.2.1 Surface Water Systems

Hydrologic Unit 9 consists largely of ponds, lakes, and marshes. As indicated in Table B.3-1, less than 10 percent of the entire area is dryland (Chabreck, 1968). The southwestern Louisiana marshes are part of the Chenier Plain, which is characterized by natural barriers to north-south drainage. In addition, man-made levees are present in numerous locations.

The surface water system in the vicinity of the West Hackberry dome consists of a brackish marsh interlaced by a network of bayous and canals which connect with Black Lake, Calcasieu Lake, Calcasieu River, Calcasieu Ship Channel, and the ICW. Pertinent characteristics of the surface water bodies nearest the dome are tabulated in Table B.3-2, and the general arrangement of these water bodies is depicted in Figure B.3-9. Water quality data from these water bodies, including recent preliminary samplings as part of DOE baseline sampling program, are given in Appendix D.

When constructed, the ESR oil pipeline route associated with the West Hackberry facility will extend from the western fringe of the Calcasieu River Basin, through the Sabine River Basin to the Neches River Basin. As shown in Figure B.3-10 the pipeline crosses Black Lake, two rivers (Sabine and Neches), and two major bayous (Black and Cow). For more than 12 miles the pipeline would be laid along the southern bank of the ICW.

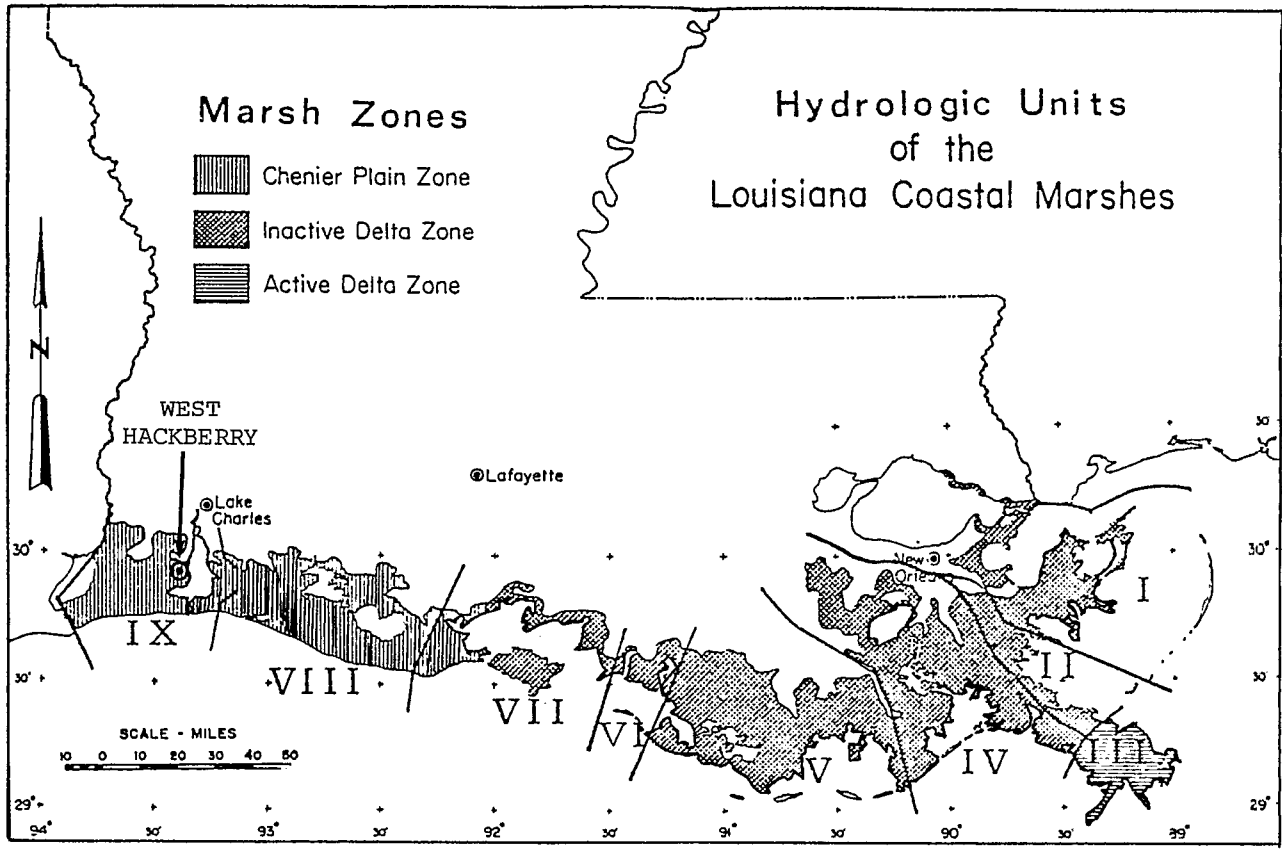

Figure B.3-7 Hydrologic Units of the Louisiana Coastal Marshes (Chabreck, 1972)

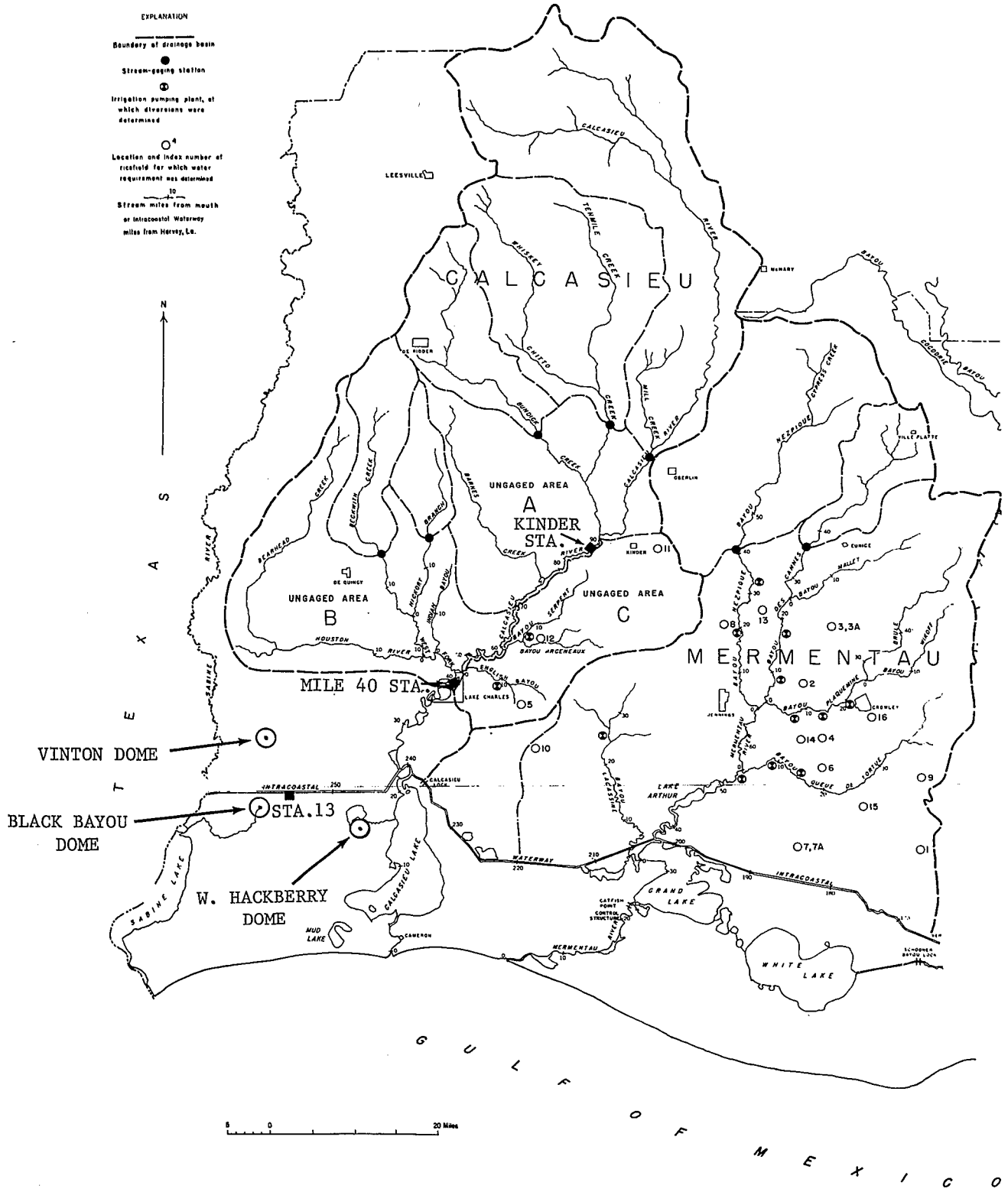

Figure B.3-8. Calcasieu River Drainage Basin Areas (Jones, et al, 1965)

Table B.3-1 Acreages in Water for Hydrologic Unit 9* in Southwest Louisiana Coastal Area
(Chabreck, 1968)

<u>Surface Feature</u>	<u>Acreage</u>
Marshes	
Natural Marshes	212,362
De-Watered Marshes	39,858
Water Bodies	
Ponds and Lakes	228,552
Bays and Sounds	-
Bayous and Rivers	2,363
Canals and Ditches	3,855
Dry Land*	51,746
TOTALS	539,635

* Includes active beaches, cheniers, spoils deposits, ridges, elevated bayous, and lake banks.

Table B.3-2 Surface Water Bodies in the Vicinity of West Hackberry Dome (Barrett, 1970)

Name	Location		Length (miles)	Width (ft)	Depth (ft)	Area (sq. miles)
	Distance(mi)	Direction				
Black Lake	0.6	NW	-	-	4.0	3.40
Black Lake Bayou	0.5	NE	6.4	100	4.0	0.12
Browns Lake	3.9	SW	-	-	3.0	0.36
Calcasieu Lake	4.7	E	-	-	1.5	11.30
			-	-	4.5	34.90
			-	-	7.5	20.60
			-	-	10.5	0.03
Calcasieu River*	7.0	NE	24.9	850	22.0	6.10
Calcasieu Ship Channel*	4.0	E	26.0	250	35.0	1.20
First Bayou	15.0	SSW	2.5	50	1.5	0.02
Hog Island Gully	6.0	S	4.9	60	1.5	0.06
Intracoastal Waterway*	4.1	N	104.5	300	8.0	5.90
Long Point Lake	6.0	SE	-	-	2.5	0.20
Mud Lake	6.5	NE	-	-	1.5	0.58
			-	-	4.5	0.29
			-	-	7.5	0.07
			-	-	10.5	0.06
			-	-	13.5	0.06
			-	-	20.0	0.10
Second Bayou	12.5	S	2.0	30	1.5	0.01
Starks Canal	2.8	SE	21.6	40	2.5	0.16
Starks North Canal	2.6	SW	18.2	40	2.5	0.14
West Cove	8.0	S	-	-	1.5	9.80
			-	-	4.5	6.00
West Cove Canal	6.3	S	-	40	1.5	0.02
West Fork	12.0	S	2.6	200	4.0	0.10

* Includes only portions within Hydrologic Area 9.

B.3-17

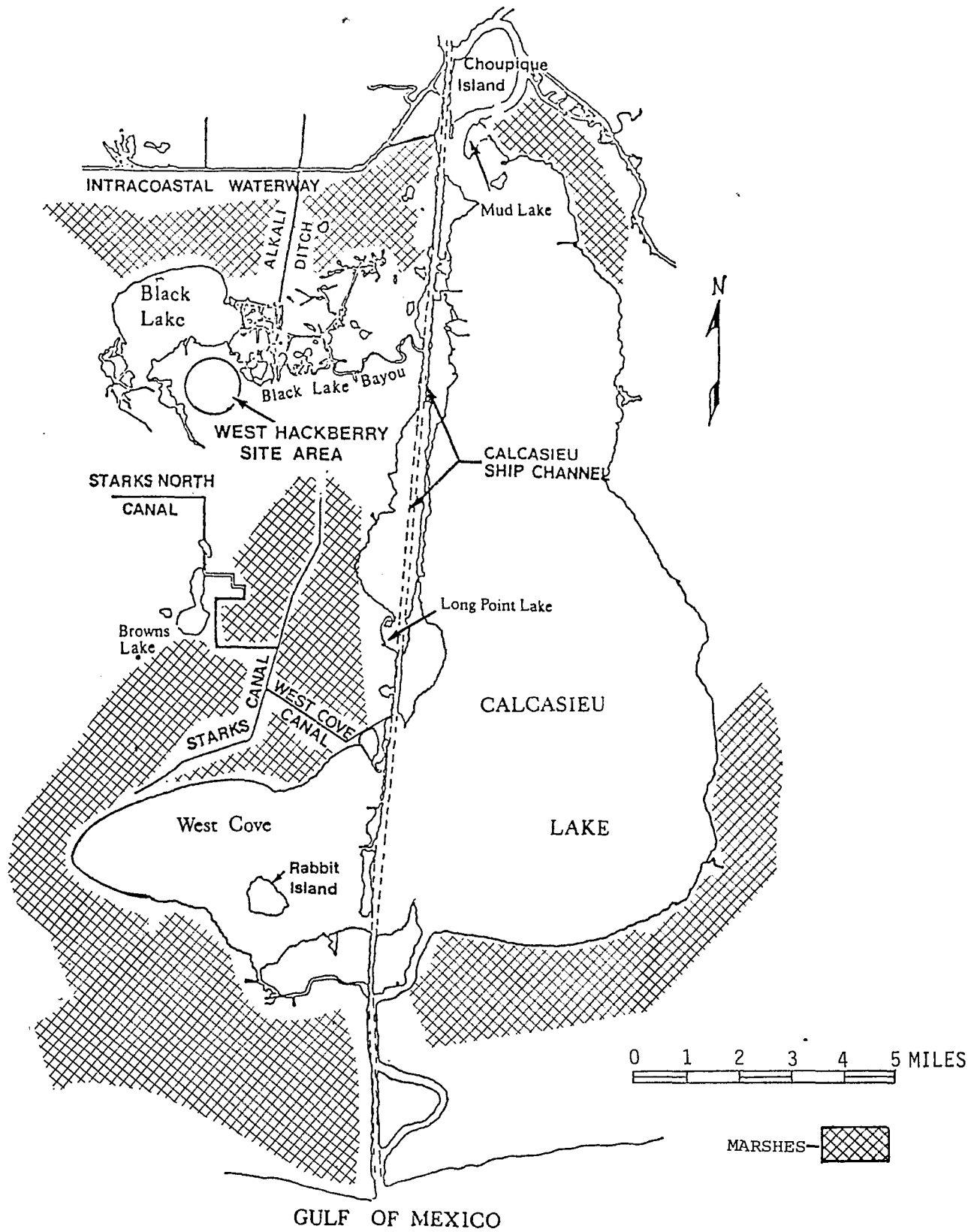
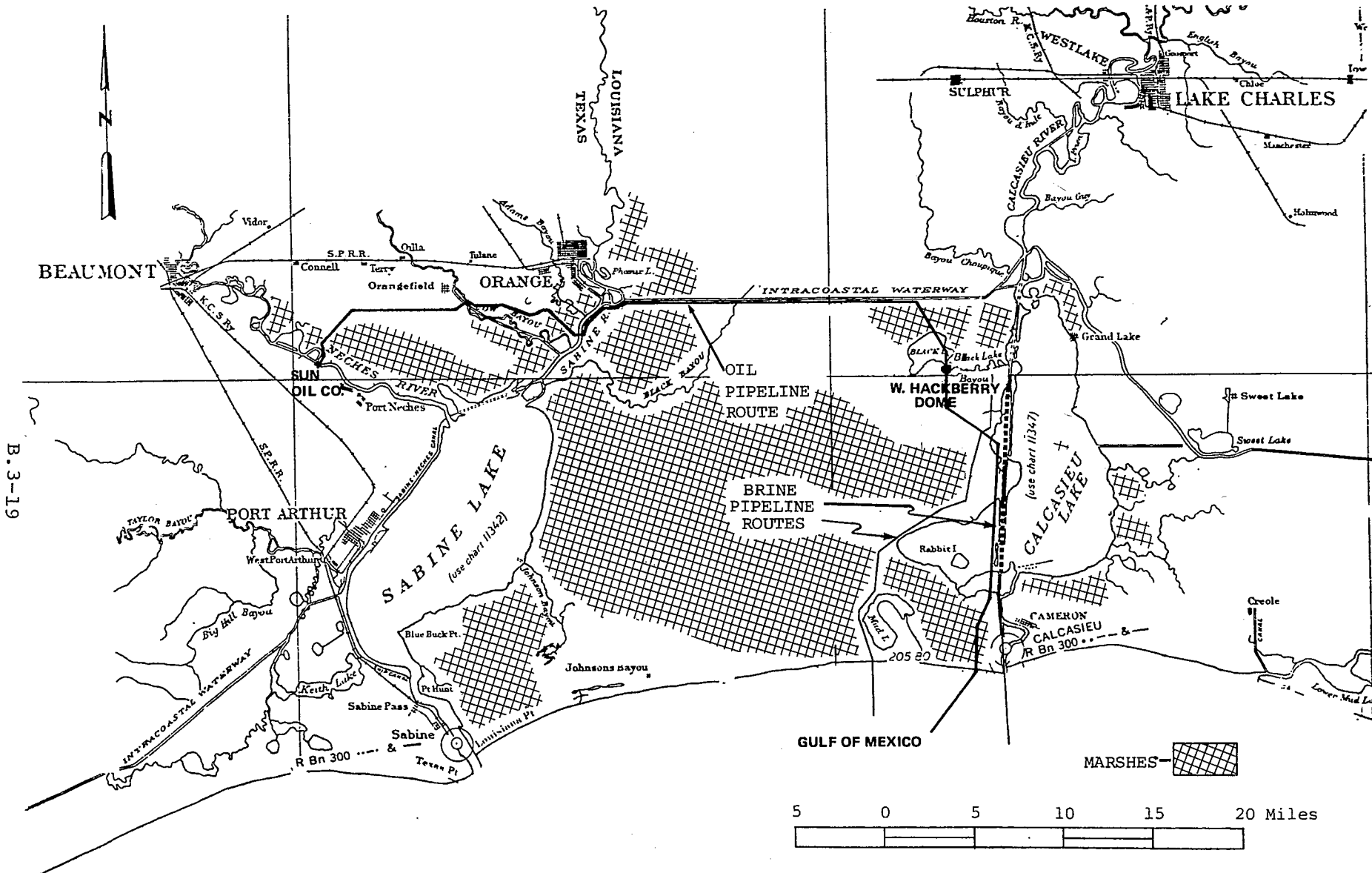

Figure B.3-9 Surface Water System in the Vicinity of the West Hackberry Site.



B.3-19

Figure B.3-10 Surface Water System Associated with Pipelines from West Hackberry Dome

As indicated in Figure B.3-10, two brine pipeline routes to the Gulf from West Hackberry are under consideration. The proposed route would run essentially parallel to the Calcasieu Ship Channel, passing through the West Cove of Calcasieu Lake, and crossing State Highway 27/82 before entering the Gulf of Mexico. The alternate route would avoid any sizable water body, crossing only Starks Canal, Hog Island Gully, Second Bayou, and First Bayou before reaching the Gulf.

As already noted, precipitation in the area is fairly heavy, amounting to 55 inches per year (Chabreck, 1968). The average precipitation surplus for winter-spring and summer-fall amounts to 14 and 4 inches respectively (Gagliano, 1970). However, during the growing season (from February through November) an average seasonal deficit of about 6 inches of precipitation is encountered in the vicinity of West Hackberry dome (see Appendix D). The water balance in the area has been described as one of "feast or famine" (Gagliano, 1970).

Coupled with the seasonal deficit of precipitation, saltwater intrusion is a significant environmental problem in the region surrounding the West Hackberry dome. In the immediate vicinity of the dome, saltwater intrusion has produced brackish surface waters with salinities between 5.0 and 10.0 ppt as indicated in Figure B.3-11 (Chabreck, 1972).

Subsequent portions of this subsection deal with various bodies of water in the following order:

- Black Lake, Black Lake Bayou and Alkali Ditch
- Calcasieu Lake, Calcasieu River and Calcasieu Ship Channel
- Gulf Intracoastal Waterway
- Sabine River
- Cow Bayou
- Neches River
- Marshes and miscellaneous water bodies
- Gulf of Mexico

For each body of water, where available, pertinent hydrologic data are discussed along with applicable water quality standards and criteria.

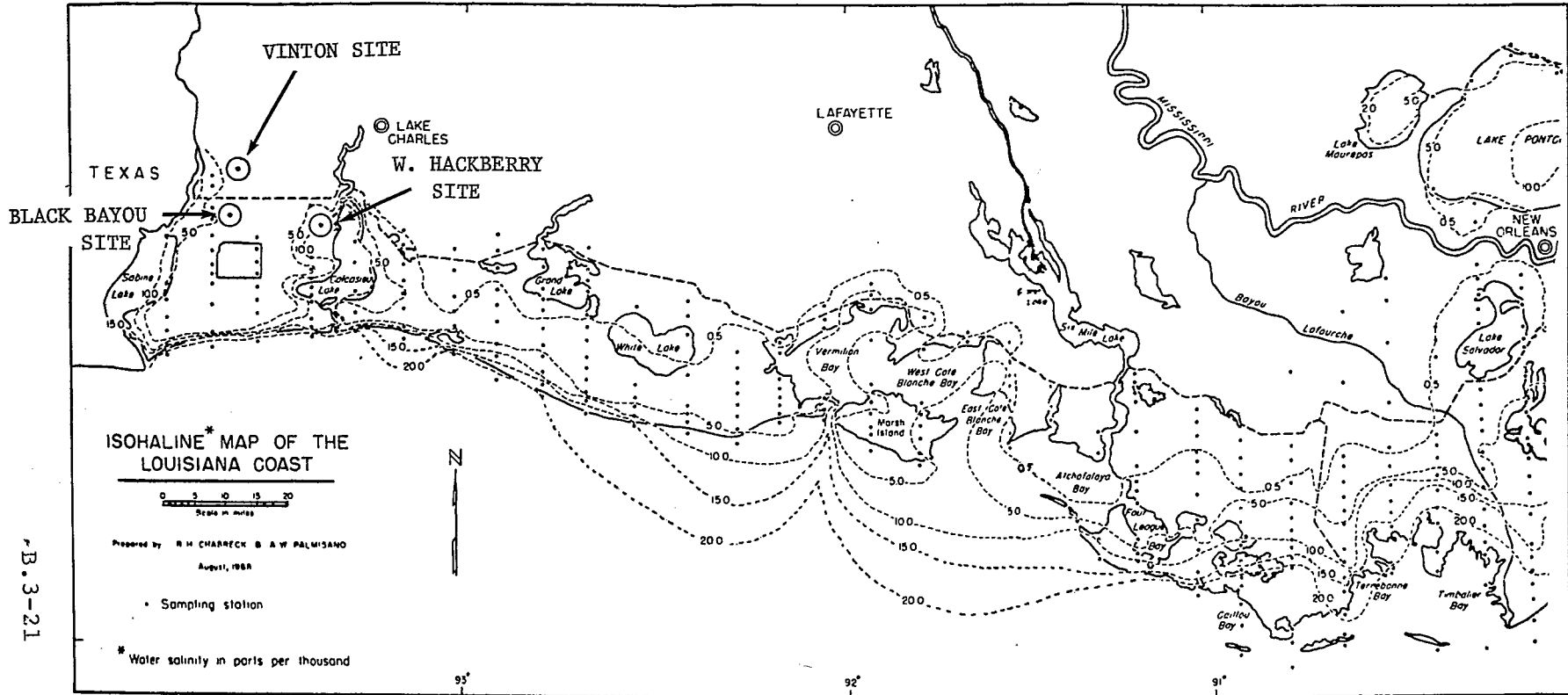

Figure B.3-11. Isohaline Map of Louisiana Coast (Chabreck, 1972)

B.3-21

Black Lake, Black Lake Bayou and Alkali Ditch

As indicated in Table B.3-2 and Figure B.3-9, Black Lake is a small shallow body of water approximately 3.4 square miles in area located on the northwestern fringe of the dome. The water in the lake is saline, with the salinity increasing in recent years. Current salinity values are dependent on tides and currents and vary from 0 to 12 ppt. The average salinity is on the order of 5 to 6 ppt (Rocca, 1976). Recent preliminary samplings taken for the purposes of this statement revealed 4.8-5.6 ppt in Black Lake and 6.5 ppt in Black Lake Bayou (see Appendix D.26). Water in the vicinity may be subject to contamination from existing brine holding facilities (Elias, 1976). Contamination by brine as a concomitant of oil production is also quite common in the area (Jones, 1956). Black Lake has been increasing in surface area, probably as a consequence of erosion. Wooden bridges, dredged channels, and oil wells are present in the lake and subsidiary canals connect the lake with the surrounding oil fields. The lake is naturally connected to Calcasieu Ship Channel via Black Lake Bayou, (4 feet deep, 100 feet wide) and is also linked to the ICW by means of Alkali Ditch (6 feet deep, 100 feet wide) as shown in Figure B.3-9. Thus, water quality in Black Lake is related to water quality in both the ICW and Calcasieu Ship Channel.

Calcasieu Lake, Calcasieu River and Calcasieu Ship Channel

The dominant bodies of water in the dome area are Calcasieu Lake and the Calcasieu River which feeds the lake. Mud Lake,* Long Point Lake and West Cove are extensions of Calcasieu Lake. The Calcasieu Ship Channel extends northward from the Gulf in the vicinity of the original Calcasieu River bed and passes along the western side of the lake as shown in Figure B.3-9. Further upstream, above the ICW, the ship channel and the river bed essentially coincide. The lower portion of this channel provides direct connection between the Gulf and Calcasieu Lake and is largely responsible for the saltwater intrusion problem which extends up the Calcasieu River to the vicinity of Lake Charles.

Volumetric flow data for the Calcasieu River are presented in Appendix D. As indicated in this appendix, as of 1976, the average flow rate for 36 years at Kinder was 2,573 cfs. This station, however, is considerably upstream of the point at which the river empties into Calcasieu Lake. The flow at the latter point is significantly greater because of tributaries which feed into the river between Kinder and Calcasieu

*The Mud Lake referred to is located at the northern end of the Calcasieu Lake.

Lake. During the period from October 1947 to October 1951 the flow rate of the entire river basin averaged 4,900 cfs (Jones et al, 1956). Seasonal variation in the river's flow rate is quite pronounced; measurements taken at Kinder from October 1975 through September 1976 varied from 3,937 cfs in March to 389 cfs in September. The variation in flow rate in the river is closely linked with the variations in precipitation for this part of Louisiana.

Currents in both Calcasieu Lake and the lower portions of Calcasieu River are strongly influenced by tidal conditions. The diurnal range of tides in both the river and the lake is 0.5 feet or less (National Oceanic and Atmospheric Administration, 1975). Winds frequently augment the tides in creating currents toward Black Lake. During winter, strong northerly winds tend to oppose incoming tides, sometimes depressing them 2 feet. With strong southerly winds, incoming tides can be increased as much as one foot above the normal tidal fluctuations. Prolonged periods of such winds may flood the marshes. Similar flooding can result from strong tropical storms and hurricanes which push saline water far inland (Chabreck, 1972).

Due to the presence of the ship channel, the Calcasieu River is navigable for drafts up to 40 feet from the Gulf to slightly north of Lake Charles. The river and surrounding surface waters in the area are used for transportation, commercial fishing, occasional industrial water supply, rice farming, and dilution of industrial and domestic wastes. To prevent further flow of saltwater upstream, the Calcasieu River Salt Water Barrier was constructed at Westlake, just above Lake Charles.

Industry along the Calcasieu River Basin includes chemical, petroleum, natural gas, salt, fish oil, and seafood processing. These industries and the municipal sewage treatment facilities of the area discharge considerable wastes into the basin, but only limited discharge data are available (provided in Appendix D).

The use of surface waters for transportation, agriculture and industrial development has clearly taken its toll on the water quality in this area. The most significant water quality problems are associated with: (1) saltwater intrusion into the freshwater marshes, lakes, rivers, and waterways; (2) contamination by agricultural fertilizers and pesticides; (3) industrial and municipal discharges; and (4) extensive engineering modification of surface water flow patterns.

The salinity of Calcasieu River and Calcasieu Lake is strongly affected by the flow rate in the river. Salinity increases have been empirically correlated with increases in river flow rates (Hershman, 1973).

The pertinent state water quality standards and federal water quality criteria for the Calcasieu River, Ship Channel and Lake are provided in Appendix D. The results of a comparison of these standards and criteria with water quality data collected at 23 sampling stations in the area are summarized in Table B.3-13. As noted in Table B.3-3, water in the river generally exceeds the EPA criteria for marine aquatic life (EPA, 1976) for mercury, phosphorus, and phenols. In addition, there is one instance where the level of dissolved oxygen and the pH of the water were in violation of the Louisiana state standards.

A limited amount of standard elutriate test* data is available for the Calcasieu Ship Channel and is tabulated in Appendix D. A comparison of these data with the appropriate state water quality standards and federal water quality criteria is presented in Table B.3-4. The tabulated results indicate that the level of mercury and phenols in the elutriate were in excess of the EPA criteria for marine aquatic life (EPA, 1976) in 50% of the samples.

In addition to water quality and elutriate test data, some sediment quality data are also available and are included in Appendix D. The results of a comparison of these data with recommended criteria,** included in Appendix D are summarized in Table B.3-5. As indicated in the table, the level of zinc, mercury, COD, and TKN in the sediment generally exceeded the unofficial criteria for sediment presented in Appendix D.3.

*The standard elutriate test is designed to predict the release of sediment pollutants into the water. Both sediment and water samples must be from the same location. The test consists of vigorously shaking one part bottom sediment with four parts water, on a volume basis, for 30 minutes, followed by a one-hour settling time and appropriate centrifugation and .45 um filtration. The concentration of various components suspended and dissolved in the water are then measured. Resulting concentrations are compared with the water quality standards and criteria applicable to the water at the sample site.

**Neither state water quality standards or federal water quality criteria are directly applicable to sediment quality. For purposes of comparison certain unofficial criteria are recommended (O'Neal and Scerva, 1971; Slotta and Williamson, 1974).

Table B.3-3 Summary of Water Quality Analysis

Body of Water	Sample Station + / Mile#	Date	Violates State Standards	Exceeds EPA* Numerical Criteria	Poses a Possible Problem
Calcasieu River	15.0	06-29-76		Mercury, Phosphorus	Low Dissolved Oxygen
"	15.0	06-30-76		Phosphorus	
"	Sta. 8A	04-04-75		Phenols	Oil & Grease
"	Sta. 8A	04-06-75		Mercury, Phenols	
"	Sta. 9	1975	Low Dissolved Oxygen, pH	Mercury, Phosphorus, pH	Oil & Grease
"	14.5	02-11-76		Phosphorus, Phenols	
"	13.4	01-15-76		Phosphorus	
"	13.0	06-29-76		Phosphorus	
"	13.0	06-30-76		Phosphorus	
"	12.6	01-15-76		Mercury, Phosphorus	
"	19.0	03-04-76		Phosphorus	
"	Sta. 11	1975		Mercury, Phosphorus	
"	17.7	06-29-76		Mercury, Phenols	Low Dissolved Oxygen
"	17.7	06-30-76		Phosphorus	
"	17.6	03-31-76		Phosphorus	Low Dissolved Oxygen
"	17.5	02-18-76		Phosphorus, Phenols	
"	Sta. 7	04-04-75		Phenols	Oil & Grease

B.3-25

Table B.3-3 Summary of Water Quality Analysis (Concluded)

Body of Water	Sample Station +/ Mile#	Date	Violates State Standards	Exceeds EPA* Numerical Criteria	Poses a Possible Problem
Calcasieu River	Sta. 7	04-06-75		Mercury	Oil & Grease
"	16.5	02-04-76		Phosphorus, Phenols	
"	Sta. 10	1975		Mercury, Phosphorus	Oil & Grease
"	12.1	06-29-76		Mercury	
"	11.5	02-06-76		Phosphorus, Phenols	
"	Sta. 8	1975		Mercury, Phosphorus	Oil & Grease Low Dissolved Oxygen
"	11.3	02-11-76		Phosphorus, Phenols	
"	10.0	04-07-76		Phosphorus, Phenols	
Calcasieu Lake (West Cove)	At Rabbit Island	06-29-76		Phosphorus	
"	"	06-30-76		Phosphorus, Phenols	
Calcasieu River	1.0	06-29-76		Mercury, Phosphorus	
"	1.0	06-30-76		Mercury, Phosphorus	Low Dissolved Oxygen

B.3-26

+The location of all sample stations are shown in Figure D.4-1.

*Marine Water Constituents, provided in Appendix D.3.

Table B.3-4 Summary of Elutriate Analysis

Body of Water	Sample Station ⁺	Date	Exceeds EPA* Numerical Criteria	Poses a Possible Problem
Calcasieu Ship Channel	11	06-10-75	Mercury	
"	7	04-04-75	Phenols	
"	7	04-06-75	Phenols	
"	10	06-10-75	Mercury	
"	8A	04-04-75	Phenols	
"	8A	04-06-75	Phenols	
"	9	06-10-75	Mercury	
"	8	06-10-75	Mercury	

B.3-27

⁺The location of all sample stations are shown in Figure D.4-1.

*Marine water constituents, provided in Appendix D.3.

Table B.3-5 Summary of Sediment Analysis

Body of Water	Sample Station ⁺	Date	Exceeds Unofficial Criteria*
Calcasieu Ship Channel	7	04-04-75	Zinc, COD and TKN
"	7	04-06-75	Zinc, COD, TKN and Mercury
"	10	06-10-75	Mercury
"	8A	04-04-75	Zinc and TKN
"	8A	04-06-75	Zinc, COD and TKN
"	9	06-10-75	Mercury

⁺The location of all sample stations are shown in Figure D.4-1.

*Included in Appendix D.3.

Gulf Intracoastal Waterway (Louisiana Segment)

The ICW lies 4.1 miles north of the West Hackberry Dome. It has a width of 300 feet with a dredged depth of 40 feet in this region. Currents in the waterway are variable and are primarily the result of tidal and wind effects. A limited amount of water quality data has been collected on the waterway 12.5 miles west of Calcasieu Lake (Station 13) and is included in Appendix D. The location of this station is indicated in Figure D.4-1. A comparison of the available data with applicable state water quality standards and federal water quality criteria is provided in Table B.3-6. Recent preliminary samplings, taken for the purposes of this statement, were taken from a point 3 miles east of Station 13 in April 1977. In this sample the ICW appeared to be quite fresh (0.08 ppt salinity) and the level of mercury equaled, but did not exceed EPA recommended criteria (see Appendix D.26).

Sabine River

The Sabine River forms the boundary between southwestern Louisiana and southeastern Texas. The pipeline would cross the river approximately 3 miles downstream of the junction of the ICW with the river. This portion of the river coincides with the Sabine River Ship Channel which is maintained at a dredged depth of 30 feet. The river width is approximately 1000 feet. Practically no periodic tides occur in this reach of the river. The rise and fall of the water depend upon the meteorological conditions. Currents in the river are about 4.2 ft/sec during high stages (National Oceanic and Administration, 1976). Approximately 21 miles upstream near Ruliff, Texas, hydrologic data are available (U.S.G.S., Texas, 1975). A portion of this data is presented in Appendix D. The volumetric flow of the river during the period October 1974 through September 1975 varied from a minimum of 774 cfs (on October 14) to a maximum of 40,700 cfs (on May 14). The mean flow rate was 14,210 cfs. It should be noted that the river flow is regulated by releases from Toledo Bend Reservoir.

Near the vicinity where the crude oil pipeline would cross the river, both water quality and sediment quality data are available for three sampling stations (U.S. Army Corps of Engineers, Galveston, 1975). The locations of these stations are indicated in Figure D.5-1 of Appendix D and the measured data are included in the same appendix. Recent preliminary samplings taken for the purposes of this statement are given in Appendix D.26. The results of a comparison of the available water quality data with pertinent state standards and federal criteria are summarized in Table B.3-7.

The available sediment quality data are compared with the recommended criteria for certain sediment parameters in Table B.3-8.

Table B.3-6 Summary of Water Quality Analysis

Body of Water	Sample Station ⁺	Date	Violates State Standards	Exceeds EPA* Numerical Criteria	Poses a Possible Problem
Intracoastal Waterway	13	03-23-75		Phosphorus, Arsenic, Mercury, Toxaphene, Lindane, Heptachlor, Aldrin, Chlordane, Dieldrin, Endrin, O,P'-DDT	Oil & Grease Heptachlor Epoxide, Methoxy-chlor, P,P'-DDT O,P'-DDE P,P'-DDE O,P'-DDD P,P'-DDD

B.3-30

⁺The location of sample station 13 is shown in Figure D.4-1.

*Marine water constituents, provided in Appendix D.3.

Table B.3-7 Summary of Water Quality Analysis

Body of Water	Sample Station ⁺	Date	Violates State Standards	Exceeds EPA Numerical Criteria*
Sabine River	SN-15	09-25-74		Cadmium, Mercury, Copper, Lead
"	SN-16	09-25-74		Cadmium, Mercury, Copper, Lead
"	SN-17	09-25-74		Cadmium, Mercury, Copper, Lead
Cow Bayou	CB-3	09-25-74	No State Standard	Cadmium, Mercury, Copper, Lead
"	CB-4	09-25-74	No State Standard	Cadmium, Mercury, Copper, Lead
Neches River	NR-2	09-25-74		Cadmium, Mercury, Copper, Lead
"	NR-3	09-25-74		Cadmium, Mercury, Copper, Lead
"	NR-4	09-25-74		Cadmium, Mercury, Copper, Lead

⁺The location of all sampling stations are shown in Figure D.5-1.

*Marine water constituents, provided in Appendix D.3.

Table B.3-8 Summary of Sediment Quality Analysis

Body of Water	Sample Station ⁺	Date	Exceeds Recommended Criteria*
Sabine River	SN-15	09-25-74	TKN, COD, Oil and Grease, Zinc
"	SN-17	09-25-74	TKN, COD, Oil and Grease, Zinc
Cow Bayou	CB-3	09-25-74	TKN, COD, Oil and Grease, Zinc, Lead
"	CB-4	09-25-74	TKN, COD, Oil and Grease, Zinc, Lead
Neches River	NR-2	09-25-74	TKN, COD, Oil and Grease, Zinc, Lead
"	NR-3	09-25-74	TKN, COD, Oil and Grease, Zinc, Lead
"	NR-4	09-25-74	TKN, COD, Oil and Grease, Zinc, Lead.

B.3.32

⁺The location of all sampling stations are shown in Figure D.5-1.

*Included in Appendix D.3.

Cow Bayou

As indicated in Figure B.3-10, the pipeline would cross Cow Bayou at a point approximately 6 miles upstream of the junction of the bayou with the Sabine River. The bayou at this point is approximately 280 feet wide with a dredged depth of 10 feet (National Oceanic and Atmospheric Administration, 1975). Volumetric flow rates for the bayou are available near Mauriceville, Texas, approximately 11 miles upstream of the crossing point (USGS, Texas, 1975). These data are included in Appendix D.5. During the period from October 1974 through September 1975 the flow rate varied from a maximum of 2060 ft³/sec in June to a minimum of .05 ft³/sec in October. Because of the many connections joining Cow Bayou and other bayous and canals in the region with the gauging station and the pipeline crossing, it is not certain if these flow rates are truly representative of the portion of the Cow Bayou.

No specific water quality standards for Cow Bayou have been published by the State of Texas. For this reason the water uses for which this stream is intended are unknown. The most appropriate* federal criteria would be the criteria for marine water constituents (aquatic life) which are included in Appendix D.

Water and sediment quality data are available for two sampling stations on the bayous as indicated in Figure D.5-1 of Appendix D.5 (U. S. Army Corps of Engineers, Galveston, 1975). One of these stations (CB-4) is immediately downstream of the pipeline crossing point while the other (CB-3) is located approximately 1.5 miles downstream. The water and sediment quality are included in Appendix D.

Examination of the water quality data reveal that with the exception of lower levels of chlorides, the water in Cow Bayou is generally similar to that in the Sabine River. The results of an analysis of the water quality data are summarized in Table B.3-7, while sediment data is presented in Appendix D.

*Cow Bayou lies between the Sabine and Neches Rivers. The lower reaches of both rivers are classified as tidal and the lower reach of Cow Bayou should also be tidal. For tidal streams the EPA criteria for marine water constituents (aquatic life) are appropriate.

Neches River

The crude oil pipeline would cross the Neches River, as indicated in Figure B.3-10 approximately 8 miles upstream of the point where the river empties into Sabine Lake. The river in this area has a width of approximately 800 feet with a dredged channel depth of 40 feet (U. S. Army Corps of Engineers, Galveston, 1975). Periodic tides are weak in the river with the rise and fall of the water depending upon meteorological conditions (National Oceanic and Atmospheric Administration, 1976). The nearest gauging station on the river is located at Evadale, Texas approximately 31 miles upstream of the crossing point (USGS-Texas, 1975). Volumetric flow data collected at this station during the period of October 1974 through September 1975 are included in Appendix D. During this period the flow rate ranged from a maximum of 19,800 ft³/sec (January 26-27) to a minimum of 1,780 ft³/sec (September 19), with a mean flow rate of 9.905 ft³/sec.

Water quality and sediment quality data for three stations along the river in the vicinity of the pipeline crossing are included in Appendix D (U. S. Army Corps of Engineers, Galveston, 1975). The locations of these sampling stations are indicated in Figure D.5-1. An analysis of water and sediment quality was made and the results are shown in Table B.3-7 and B.3-8 respectively.

Marshes and Miscellaneous Water Bodies

The oil pipeline along most of its route would be located in or near marshland. The proposed brine disposal route from West Hackberry to the Gulf along Louisiana Highway 27 passes through marshes. Between Sabine and Calcasieu Lakes these marshes represent a portion of the large wetlands area within which the Sabine National Wildlife Refuge is located. Fresh, intermediate, and brackish marshes are included. Salinity measurements in this area display a wide range of values (0.40 to 14.85 ppt) from month to month (Sabine National Wildlife Refuge, 1973-76). The water is generally turbid and shallow, with a depth of one to two feet. Seasonal precipitation, as well as tidal effects, have a strong effect on the depth of the water.

Situated in the marshes are a number of small bayous, canals, and gullies which may be crossed by the oil or brine pipelines. These include Starks Canal, Hog Island Gully, Second Bayou, and First Bayou. The physical dimensions of these water bodies are included in Table B.3-2.

In Texas, between the Sabine and Neches Rivers on either side of Cow Bayou, marshes similar to those found in Louisiana are also encountered.

Coastal Waters of the Gulf of Mexico Near West Hackberry

The shallow coastal waters of the Gulf of Mexico south of West Hackberry constitute the primary brine disposal site. To attain the desired 30-foot depth for disposal, a site would be a minimum of 5 miles offshore. The bottom composition in this area is clayey sand south of Calcasieu Pass, but changes to silt south of Holly Beach (Bureau of Land Management, 1975).

Along that portion of the Calcasieu Ship Channel extending from the coastline out into the Gulf some water and sediment quality data have been collected and are included in Appendix D. The results of a comparison of these data with appropriate criteria are summarized in Table B.3-9.

The salinity of the Gulf in the potential disposal area is affected by the discharge of rivers along the Louisiana coast, tides, precipitation, and other factors. The average salinity in Calcasieu Pass (approximately 5 miles north of disposal site) during the period April 1968 to March 1969 was 18.5 ppt (Barrett, 1971). Surface salinities at the West Hackberry disposal site, as measured from September to December 1977, ranged from 22 to 28 ppt.

Because of the high turbidity of the Calcasieu River the Gulf waters in the area are likewise somewhat turbid. The concentration of trace metals such as cadmium, lead, chromium, zinc, and manganese is on the order of 10 times the concentrations typically* observed in open ocean waters (Corcoran, 1972).

Surface currents in the area are variable, being strongly affected by winds, tides, and other conditions. Mean surface currents 12 miles south of the potential discharge area are illustrated by the current rose in Figure B.3-12. As indicated in this figure, the most likely current sets to the west (270°) with a drift of 1.0 knot (Bureau of Land Mgmt., 1975d). In the vicinity of Calcasieu Pass, the maximum drift is 2.3 knots (National Oceanic and Atmospheric Administration, 1975d). The diurnal range of the tide here is 2 feet (National Oceanic and Atmospheric Administration, 1975b). Figure B.3-12 provides some indication of prevailing winds as shown on the wind rose for the area. The most likely wind is from the southeast (135°) at 11.6 knots. Additional detailed oceanographic data are provided in a related report (NOAA, 1977). Finally, a detailed description of site specific physical oceanography determined during a field study for this EIS, is presented in Appendix U.2.

*Typical trace element concentrations in open ocean waters are:
cadmium - 0.0003 ppm; lead - 0.004 ppm; copper - 0.001 ppm;
chromium - 0.001 ppm; zinc - 0.009 ppm; and manganese - 0.001 ppm
(Levine, 1968).

Table B.3-9 Summary of Water Quality Analysis

Body of Water	Sample Station +	Date	Violates State Standards	Exceeds EPA* Numerical Criteria	Poses a Possible Problem
Gulf of Mexico	Mile (-5.6) 300 yrds West of Calcasieu Ship Channel	09-07-76	No State Standard	Phosphorus	PCB's in bottom sediment
"	Mile (-2.9) 300 yrds West of Calcasieu Ship Channel	09-08-76	"	Phosphorus, Phenols	
"	"	06-29-76	"	Phosphorus, Mercury	
"	"	06-30-76	"	Phosphorus	
"	"	09-08-76	"	Phosphorus, Phenols	
"	Mile (-2.9) 200 yrds East of Calcasieu Ship Channel	09-08-76	"	Phosphorus, Phenols	Oil & Grease, PCB's in bottom sediment
"	Mile (-2.9) Calcasieu Ship Channel	06-29-76	"	Phosphorus	
"	"	06-30-76	"	Phosphorus	
"	Mile (-0.4) 300 yrds West of Calcasieu Ship Channel	09-08-76	"	Phosphorus, Phenols	
"	Mile (-0.4) 300 yrds East of Calcasieu Ship Channel	09-08-76	"	Phosphorus, Phenols	

B.3-36

+The Location of all sampling stations are shown in Figure D.4-1.

*Marine water constituents, provided in Appendix D.3.

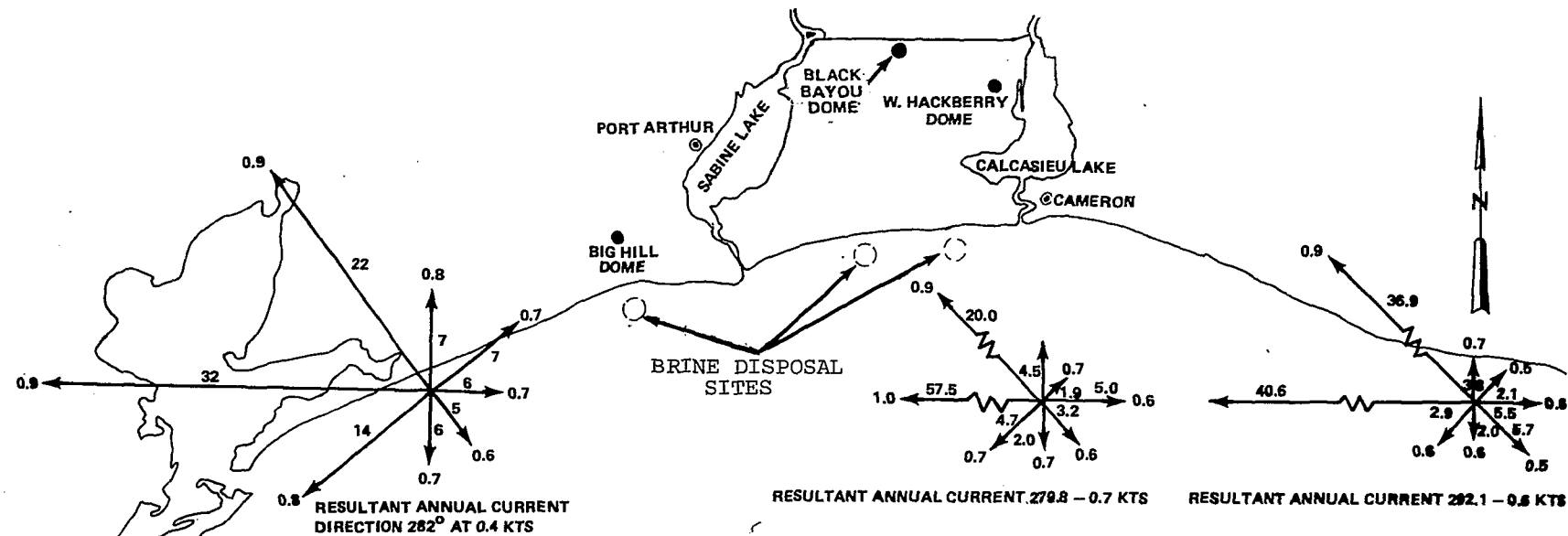

GULF OF MEXICO

Explanation for Current Rose

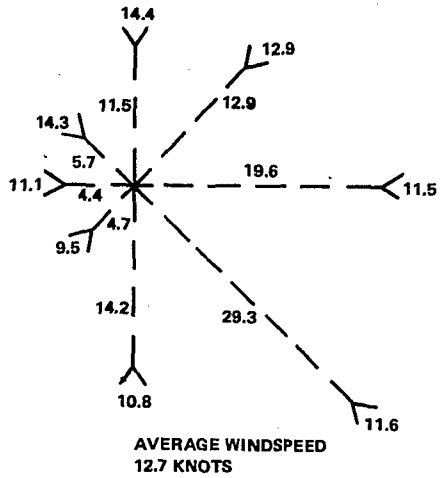
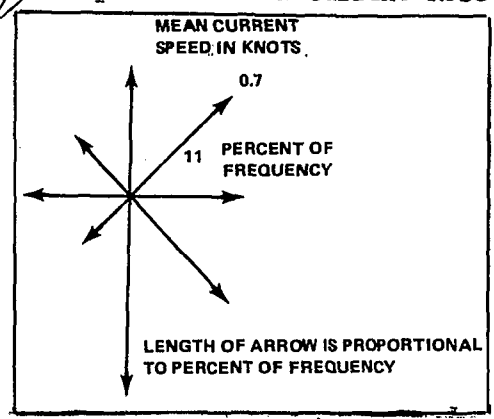

Explanation for Wind Rose

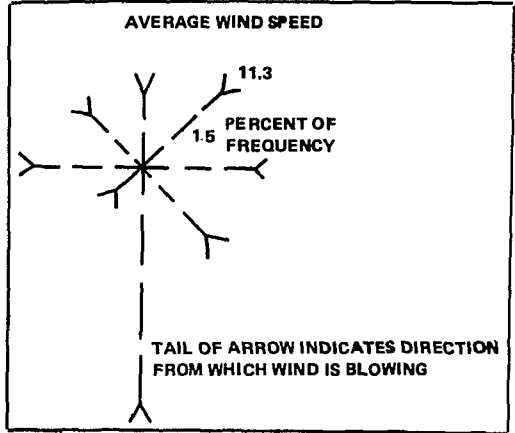

Source: Bureau of Land Management, 1975

Figure B.3-12 Currents and Winds in the Gulf of Mexico

B.3.1.2.2 Subsurface Water Systems

Southwestern Louisiana contains three shallow aquifers in the area of interest. Chicot aquifer lies closest to the surface and contains mostly fresh water north of Cameron Parish and all saline water in the coastal region. Evangeline aquifer lies under the Chicot aquifer; it contains fresh water north of Calcasieu Parish, and saline water from southern Calcasieu Parish to the coast. Jasper aquifer lies under the Evangeline aquifer and contains saline water from the middle of Beauregard Parish south to the coast (Harder et al., 1967).

The Chicot aquifer contains beds of clay, silt, sand, and gravel of Pleistocene age. The aquifer dips toward the south and southeast. It increases in thickness from less than 100 feet in Beauregard Parish to more than 7,000 feet under the Gulf of Mexico (Andrews, 1961). Near the West Hackberry site, the gulfward slope of the base is 18 feet per mile, although the slope may be distorted in the immediate vicinity of the dome. As shown in Figure B.2-5 (Section B.2.2.2) a well log approximately 10 miles from West Hackberry (sampling station 23) indicates that the aquifer extends essentially from the surface to 1,120 feet. This figure also shows 6 thin sand layers between 100 and 500 feet and 5 sand layers between 500 and 1,350 feet deep with thickness from 100 to 250 feet. Individual sand beds often have fine sand at the top, changing to coarse sand and gravel at the bottom. The coefficient of permeability varies from 900 to 2,000 gallons per day per square foot, averaging 1,500 gallons per day per square foot. Coefficients of transmissibility for individual sand beds range from 75,000 to 1,000,000 gallons per day per foot (Jones and Turcan, 1954).

Of special significance is the location of the interface between fresh and salt water. The dotted line rising vertically between wells 23 and 24 of Figure B.3.5 indicates the .25 ppt salinity line, south of which no fresh water is found in the aquifer. Before large scale water pumping started, the general direction of water flow in the aquifer was southward. Heavy water use in the Lake Charles area for municipalities, industry, and agriculture has lowered the water level and reversed aquifer flow near

West Hackberry as shown in the piezometric map* presented in Figure B.3-13.

Because of reversed aquifer flow, 1967 data showed that the .25 ppt salinity line is moving northward at an estimated rate of 30 to 200 feet per year. This rate may have increased significantly in the last few years due to dredging in the area. In addition, because the aquifer sands are interconnected vertically as well as horizontally, the lowering of the water table may cause saline water to rise and contaminate less saline layers.

For this reason, 1967 data showed that the .25 ppt salinity line is moving northward at an estimated rate of 30 to 200 feet per year. This rate may have increased significantly in the last few years due to dredging in the area. In addition, because the aquifer sands are interconnected vertically as well as horizontally, the lowering of the water table may cause saline water to rise and contaminate less saline layers.

The major recharge for the Chicot aquifer occurs at the outcrop, more than 30 miles north of West Hackberry (Jones and Turcan, 1954) (See Appendix D). The Chicot aquifer is not recharged from the surface in the West Hackberry area. Where pumping tests were performed, the Chicot responded as a confined aquifer, i.e., separate from surface recharged sources. Hundreds of feet of impermeable clay overlie the Chicot near West Hackberry (Andrews, 1961).

*Piezometric maps are water-level contour maps that show the distribution of pressure head in the aquifer, where the water is coming from, where it is going, and the route it is following. Also, the rate of ground water flow can be determined if the permeability and thickness of the aquifer are known. The difference in head in the aquifer between 2 given points is generally expressed in feet of water, and the slope of the profile of head change between them is called the hydraulic gradient, generally expressed in feet per mile. The pressure gradient in an aquifer is determined by measuring the water level (in feet above or below a common datum) in wells tapping the aquifer. Contours (lines joining points of equal altitude on the potential surface of water in a given aquifer) enable a three-dimensional analysis of head distribution.

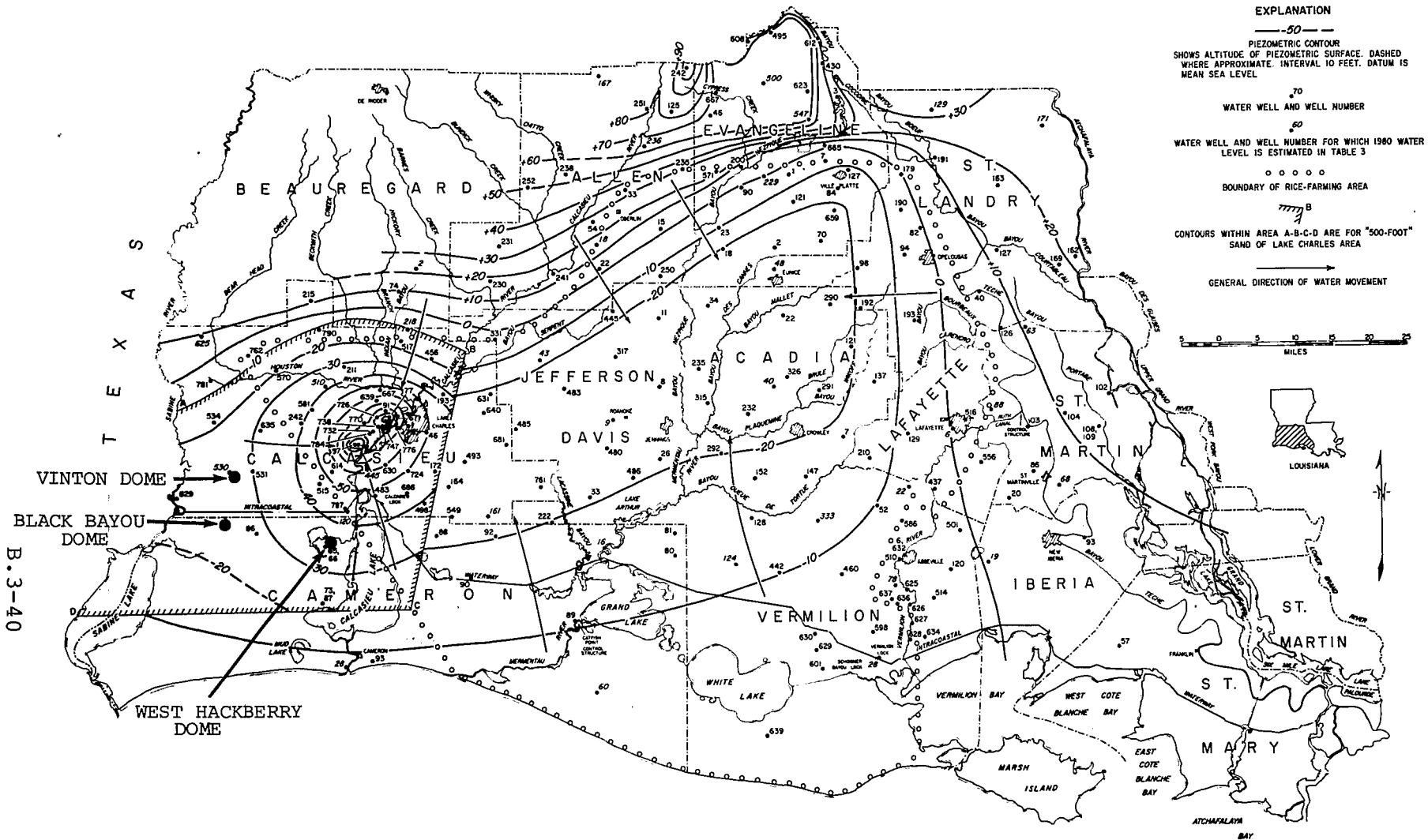

Figure B.3-13. Altitude of Piezometric Surface in the Chicot - Atchafalaya Aquifer in Southwestern Louisiana, April 1965. (Harder et al, 1967)

Data on the quantity of dissolved solids as a function of depth over this general area are given in Appendix D. The levels of dissolved solids corresponding to 1,000, 3,000, and 10,000 mg/l occur about 500, 850, and 1,100 feet respectively below mean sea level at the West Hackberry site. Chemical and physical parameters for nearby wells in Cameron Parish at depths in the interval of interest are also presented in Appendix D.

Estimates of the yield from wells in the shallow subsurface aquifers are based on a drawdown of 100 feet after one day of pumping and do not allow for the interference effects of pumping from other wells. The estimated potential yield for an individual well is both the slightly saline (1,000 to 3,000 mg/l) zones is in the 2,000 to 5,000 gallons per minute range.

In the immediate vicinity of the West Hackberry site, the principal user of shallow subsurface water is the town of Hackberry. Currently, the town's water supply consists of two wells. Well #1 has a total depth of 530 feet while well #2 has a total depth of 653 feet. The combined yield of the two wells is 200,000 gallons per day (Bushby, 1976).

The city of Sulphur, about 15 miles north of the site draws its water from 5 wells in the depth interval from 540 to 560 feet. The volumetric flow rate is about 4×10^6 gallons per minute (Guidry, 1976). Approximately 19 miles to the northeast, the city of Lake Charles also utilizes the shallow subsurface aquifers for its municipal water supply source. The water well depths range from 500 to 700 feet. The total yield is about 9×10^6 gallons per minute (Lyles, 1976).

B.3.1.3 Air Quality

B.3.1.3.1 Existing Air Quality

Since onsite monitoring has not been conducted at any of the SPR site locations, existing air quality levels at these sites can only be established based on extrapolations of available regional air quality data presented in Section B.2.3.3. The monitoring stations at Nederland, Texas; West Orange, Texas; and Lake Charles, Louisiana would be the closest to the SPR sites and therefore, probably are the most representative data sources available for describing the site specific air quality. The data from these stations (Table B.2-4) indicate that the standards for NMHC and oxidant (O_x) were violated at each of the monitoring locations.

Particulate, sulfur dioxide (SO_2), nitrogen dioxide (NO_2) carbon monoxide (CO), and hydrogen sulfide (H_2S) concentrations for the SPR site area are presently in compliance with all applicable federal and state air quality standards.

Data on the quantity of dissolved solids as a function of depth over this general area are given in Appendix D. The levels of dissolved solids corresponding to 1,000, 3,000, and 10,000 mg/l occur about 500, 850, and 1,100 feet respectively below mean sea level at the West Hackberry site. Chemical and physical parameters for nearby wells in Cameron Parish at depths in the interval of interest are also presented in Appendix D.

Estimates of the yield from wells in the shallow subsurface aquifers are based on a drawdown of 100 feet after 1 day of pumping and do not allow for the interference effects of pumping from other wells. The estimated potential yield for an individual well in both the slightly saline (1,000 to 3,000 mg/l) zones is in the 2,000 to 5,000 gallons per minute range.

In the immediate vicinity of the West Hackberry site, the principal user of shallow subsurface water is the town of Hackberry. Currently, the town's water supply consists of two wells. Well #1 has a total depth of 530 feet while well #2 has a total depth of 653 feet. The combined yield of the two wells is 200,000 gallons per day (Bushby, 1976).

The city of Sulphur, about 15 miles north of the site draws its water from 5 wells in the depth interval from 540 to 560 feet. The volumetric flow rate is about 4×10^6 gallons per minute (Guidry, 1976). Approximately 19 miles to the northeast, the city of Lake Charles also utilizes the shallow subsurface aquifers for its municipal water supply source. The water well depths range from 500 to 700 feet. The total yield is about 9×10^6 gallons per minute (Lyles, 1976).

B.3.1.3 Air Quality

B.3.1.3.1 Existing Air Quality

Since onsite monitoring has not been conducted at any of the SPR site locations, existing air quality levels at these sites can only be established based on extrapolations of available regional air quality data presented in Section B.2.3.3. The monitoring stations at Nederland, Texas; West Orange, Texas; and Lake Charles, Louisiana would be the closest to the SPR sites and therefore, probably are the most representative data sources available for describing the site specific air quality. The data from these stations (Table B.2-4) indicate that the standards for NMHC and oxidant (O_x) were violated at each of the monitoring locations.

Particulate, sulfur dioxide (SO_2), nitrogen dioxide (NO_2), carbon monoxide (CO), and hydrogen sulfide (H_2S) concentrations for the SPR site area are presently in compliance with all applicable federal and state air quality standards.

B.3.1.3.2 Projected Air Quality

Based on projected regional air quality, concentrations of nitrogen oxides, carbon monoxide, and particulates for the SPR site area are not expected to exceed standards in the next 10 years. However, sulfur oxides and nonmethane hydrocarbon levels are projected to exceed the guideline concentration which results in the projections of oxidant level exceeding standards.

B.3.1.4 Background Ambient Sound Levels

Background noise levels in and around the alternative SPR site at West Hackberry expansion are typical of a secluded essentially flat area. The area is similar in geography and surrounding land use to that described for the SPR region. Noise assessment of ambient levels for the region are contained in Section B.2.4.

B.3.1.5 Species and Ecosystems

The proposed leach water and water supply plant, water line, and water intake would be identical to that for the ESR facility. The only near-surface engineering changes would be pipelines to the new oil storage caverns to be developed immediately to the west of the caverns proposed for ESR storage. The immediate biotic environment adjacent to this system includes estuarine organisms in Black Lake, and in the marsh north of Black Lake, organisms on the dry land areas south of the ICW and biota in the ICW.

A proposed and an alternative brine disposal line passing to the Gulf of Mexico are discussed below. The settings of the routes include dry land, ship channel, marsh, and the floor and water of the continental shelf in the Gulf of Mexico.

The immediate storage site itself is dry land with pasture and natural grasses and tress. It is bordered by Black Lake and marshland.

The oil distribution lines would run in parallel across agricultural land, marshes, rivers, bayous and canals, and along spoil banks and the Intracoastal Waterway.

The engineering systems associated with the facility would lie within Cameron Parish, Louisiana; its offshore area in the Gulf of Mexico: Calcasieu Parish, Louisiana; Orange County, Texas; and Jefferson County, Texas.

B.3.1.5.1 Environmental Setting of the Displacement/Leaching Water System

The demersal nekton, based on a brief reconnaissance study, is characteristic of estuarine Louisiana waterways. At the time of the study the dominant species included the Atlantic croaker, the blue crab, and brown shrimp, all of which are of economic importance. These organisms were in at least recreationally harvestable quantities at the time of the study, but local sources suggest that this is atypical. If these local observations are correct it must be a rare occasion on which one could obtain the high catches which were seen.

The zooplankton community was wholly dominated by calanoid copepods, a situation comparable to offshore coastal waters. Numbers of small fish species, mysids, ostracods, and mayflies were also taken. This is dissimilar to offshore compositions and reflects the more inland location of the waterway.

B.3.1.5.2 Environmental Setting of the Brine Disposal System

Proposed Brine Pipeline Route

The proposed route for the brine disposal pipeline is shown in Figure 2.4-8. After leaving the storage site the pipeline would be buried along its entire extent. It would pass to the south from the central plant along the temporary brine disposal pipeline right-of-way to the ESR brine injection field. This segment would cross dry pasture land except for one area where a swale several hundred feet wide must be crossed. Swales in this area act as drainage ditches and are most often wet and heavily vegetated with scattered brush and marsh grasses. Fence rows overgrown in trees and shrubs border most of the eastern side of this section of the right-of-way. Such vegetated fence rows offer habitat for many birds and small rodents.

At the ESR injection field, the route would enter a flooded area and make a turn toward the southeast. The flooded area is a mixture of marsh and shallow open water. This open water extends south with connections to Calcasieu Lake and northwest with connections to Black Lake. The life forms in this wetlands system would be similar to those described for Black Lake. Biological areas of these types are discussed in detail in the description of regional ecosystems (Section B.2.5.2.1, Characteristics of Ecosystems in Western Cameron Parish).

Continuing in a southeastern direction, the route would cross dry land typical of pasture with scattered shrub vegetation, and then pass into a shallow lagoon and wetland area connected with, and similar to, the wetland system described earlier. The route would then intersect and pass under Highway 27 and Starks Canal, which borders on the eastern side of the highway at this location, and then enter an extensive marsh area which lies between the highway

and Calcasieu Lake to the east. The canal and adjacent marsh areas are rich in biota similar to those described for Black Lake in connection with the water supply system.

The route would enter a portion of Calcasieu Lake which lies west of Calcasieu Ship Channel and north of Long Point Lake, and then it would turn south and parallel the ship channel, at a distance approximately 0.5 miles west of the ship channel, to the Gulf. An extensive area of marsh in the vicinity of Long Point Lake would be crossed, including a portion of the Sabine National Wildlife Refuge. This marsh is connected by bayous and canals to the Calcasieu Ship Channel and portions of West Cove of Calcasieu Lake. Wind driven currents sometime rapidly transport water into the bayous and adjacent marsh areas. Fishing and crabbing are recreational activities conducted along the water bodies within the refuge and surrounding wetlands, and the area is an important protected waterfowl habitat. The marsh contains nearly all, if not all, brackish water with typical attributes of the salt marsh. These are discussed in detail in the regional description (Section B.2.5.1.1, Characteristics of Ecosystems in Western Cameron Parish and B.2.5.2.5, Terrestrial Vertebrates of the Texoma Region).

The route would also pass through the open waters of West Cove. This cove (western Calcasieu Lake) is separated from the lake proper by the Calcasieu Ship Channel, which has spoil banks on either side. However, numerous breaks in the spoil banks provide interconnection and cross flow to the main portion of the lake. Calcasieu Lake is an extremely productive fishery with many similarities to Black Lake. However, Calcasieu Lake contains important numbers of brown shrimp and American oysters in addition to most of the species present in Black Lake. Some forms which are typical of the open Gulf, such as sharks and dolphins, may venture into the lower Calcasieu and Calcasieu Lake. This area is also a haven for waterfowl, as discussed in Section A.3.5.2.5, Terrestrial Vertebrates of the Texoma Region.

South of West Cove the route would cross a broad marshland area, including St. Johns Island and West Fork Bayou, and would cross at least four roads with associated canals and borrow pits before reaching Highway 27/82 which runs along the coast. The marshland area traversed by this section of the route includes some scrub trees and areas which have become flooded behind levees which were constructed in the area. On the levee banks along which the route would pass and in the other disturbed areas along the route, a variety of shrubs, trees, grasses, weeds, sedges, and other plants, particularly pioneer plants characteristic for disturbed situations, will predominate (U.S. Army Corps of Engineers, 1976). The main trees and shrubs in these situations have been discussed under Section B.2.5.2.1, Characteristics of Ecosystems in Western Cameron Parish.

The section of beach between the highway and the Gulf shore where the pipeline route would pass is a mixture of sandy beach and saline marsh. Burrowing and psammon* organisms are present and beach-dependent fish are located offshore, as discussed in Section B.2.5.2.1, Characteristics of Ecosystems in Western Cameron Parish.

Offshore biota include a wide variety of phytoplankton and zooplankton, nekton, benthic mollusks, worms, arthropods, and starfish, as discussed in Section B.2.5.2.1. The marine food webs contain food chains based mainly on phytoplankton, rather than detritus as in the marshes.

Alternate Brine Pipeline Route

An alternative brine disposal route to the Gulf would follow the proposed route to the first intersection with Highway 27 south of Hackberry. The pipeline route would then follow Highway 27 into Sabine National Wildlife Refuge for approximately 11 miles. The route along the western side of the highway would pass along a narrow band of dryland before entering the marsh in the refuge and then the pipeline would pass into the bottom of Starks Canal which parallels the highway on the west through the refuge. The canal and adjacent marsh areas are rich in biota similar to those described for Black Lake in connection with the water supply system. Water birds are conspicuous in the marsh bordering the canal. The pipeline would continue in the canal to its southernmost point, very near the Gulf of Mexico, at which point it would pass out of the canal, across the intervening marsh and shore, and continue into the Gulf of Mexico. Starks Canal and Highway 27 pass southwestward around the western shore of West Cove before passing out of the refuge to the south. This segment of the canal receives cross canals connecting it to Calcasieu Lake, and wind driven currents sometimes rapidly transport water into the Starks Canal and adjacent marsh areas. Fishing and crabbing are recreational activities conducted along the canal within the refuge. The same general biota as are prominent in Black Lake are also prevalent here. After the canal passes south out of the refuge, it passes by the west side of Mud Lake before passing to its southernmost point near Holly Beach. The Starks Canal contains brackish water and the marsh along it is nearly all brackish marsh. The attributes of this marsh type are discussed in detail in the regional description (Section B.2.5.1.1, Characteristics of Ecosystems in Western Cameron Parish and B.2.5.2.5, Terrestrial Vertebrates of the Texoma Region).

*psammon - Small organisms which live in the interstitial spaces among the sand grains.

Holly Beach is a sandy beach at the intersection of coastline Highway 82 and Highway 27. A small settlement has been established at Holly Beach and the developed area lies immediately to the east of where the pipeline would cross into the Gulf of Mexico.

B.3.1.5.3 Environmental Setting of the Site

The central plant at the storage site, which is identical to that for the ESR project at West Hackberry salt dome, would be located to the southwest of the Olin plant buildings on the east side of the expansion storage location and south of the ESR program storage cavern wellheads. This central plant would occupy 32 acres of pastureland bordered on the east by a north-south-extending tree line. Some trees are also present in a line along the western boundary of the rectangular plant area. It is assumed that oil and brine lines to the storage caverns would be buried. They would be laid in what presently is mostly grassland, but which contains some small scattered trees and shrubs. These trees and shrubs are especially prevalent along the north side of the east-west road segment which passes through the expansion storage cavern field and also along the southwestern boundary of the expansion storage cavern field. The east-west road connects at its western end with the Amoco pumping station of the southwest shore of Black Lake.

B.3.1.5.4 Environmental Setting of the Oil Distribution System

The ESR crude oil distribution line, which would also be used for SPR expansion at either West Hackberry, Black Bayou, or Vinton, will be constructed through parts of Cameron and Calcasieu Parishes, Louisiana, and Orange and Jefferson Counties in Texas. The 42-inch diameter steel pipeline would pass northwest to the edge of the Intracoastal Waterway from the dome, continue westward along the ICW to the Sabine River, and pass southward into Cameron Parish along the river. It then crosses the river into Orange County north of Cow Bayou and continues to the Neches River. Crossing the river, the pipeline then connects with the storage facilities at the Sun Oil Company terminal. These pipelines, their environmental setting, and impacts associated with their construction and operation are described in detail in the Pipeline Design Change Supplement, Final Environmental Impact Statement for West Hackberry Salt Dome, FES 76/77-4 (FEA, 1977b). The pipeline setting is summarized below.

The route leaves the central plant area and passes due north for 0.5 miles across the dome to the shore line of Black Lake (prairie community type). It then crosses Black Lake in a north-northwesterly direction for 1.9 miles. On the

north side of the lake, the route enters marshland for 1.1 miles to the south levee of a dry land management area. After crossing the levee, the route continues 0.9 miles through a pasture community type to the spoil bank on the south shore of the ICW. Marine organisms in Black Lake have already been discussed in Section B.3.1.5.1 (Environmental Setting of the Displacement/Leaching Water System). Brackish and intermediate marsh are discussed in the regional description (Section B.2.5.1.1, Characteristics of Ecosystems in Western Cameron Parish).

The pipeline route continues west, paralleling the spoil banks on the south shore of the ICW. Most of the route to its intersection with the Gum Cove Ferry road is in cultivated or cleared land, maintained for cattle. In the vicinity of Black Bayou, the right-of-way is in freshwater marsh and intermediate marsh. Black Bayou is across from the Vinton Drainage Canal on the other side of the ICW. The Black Bayou Cutoff is encountered at approximately 3/4 of a mile farther west, where there is an interruption in the spoil banks. These waterways contain the typical aquatic biota described for the ICW and adjacent bodies of water in Section B.2.5.1.2 (Characteristics of Ecosystems in Western Calcasieu Parish). The route once again parallels the spoil banks beginning about 1/4 mile west of Black Bayou Cutoff.

The route continues from the spoil on dry land to intermediate and then brackish marsh as the Sabine River is approached. The pipeline would leave the vicinity of the spoil banks near where the ICW junctions with the Sabine River. It runs south near the east bank of the river for a short distance, crossing a canal across from Adams Bayou, and then crosses the river to the west 1.1 miles north of Cow Bayou. The segment along the eastern Sabine River generally runs along dry land and brackish marsh. Some scattered clumps of trees are present along this segment. After crossing the Sabine River the route traverses a marsh in a northwest direction for approximately 1 mile and then cleared dry land for 1 mile. The pipe then swings westward crossing high marsh, marsh, dry prairie land, Cow Bayou, gum-oak-cypress groves and a pine forest for approximately 11.25 miles. At this point the route turns southwest crossing wooded land and marsh for 2.75 miles and then south for 1.5 miles to the Neches River bank.

The biota in the Sabine and Neches Rivers and in other ecosystems along the pipeline route west of the Sabine River are discussed in detail in Section B.2.5.2.3 (Characteristics of Ecosystems in Orange County). The vegetation characteristics of the spoil banks along the ICW through which the oil pipelines would pass are discussed in Section B.2.5.2.2 (Characteristics of Ecosystems in Western Calcasieu Parish).

B.3.1.8 Socioeconomic Characteristics

B.3.1.8.1 History and Cultural Patterns

Indians once lived on the cheniers of the Gulf coastal wetlands, as evidenced by shell middens and artifacts that have been excavated. These tribes vanished at about the time that Louisiana was first being explored by the French and Spanish. The first major group of settlers in the vicinity of the Sabine and Calcasieu Lakes were of Scotch-Irish descent. These were people who had bought land grants after the War of 1812 and settled near the Gulf. Later, French and Acadian families moved here from the eastern and central coastal parishes of Louisiana.

When the first towns in Cameron Parish were settled, the schools were taught in French. As the settlements grew and developed commercial ties with other parts of the region, English became the dominant language. However, in the rural sections French names and cultural influence are perpetuated and constitute a unifying force that ties the communities together.

Coastal towns were decimated by Hurricane Audrey in 1957. Many lives were lost and many homes and businesses were destroyed. Since then, the towns have been rebuilt, giving an appearance of new wealth to areas where industrial development is limited by the threat of recurrence of such devastating storms.

B.3.1.8.2 Present Population of the Area

The proposed site for petroleum storage is located in Cameron Parish, the largest parish in the state and the least populous. The site is in a rural area composed of marshes and pasture lands. There are three small communities near the site: Hackberry, located just east of the site; town of Cameron, near one of the proposed routes for the pipeline carrying brine to the Gulf of Mexico; and Holly Beach near the route of the alternate brine pipeline (see Figure B.3-14).

Hackberry is an unincorporated community of about 1,300 people (Imperial Calcasieu Regional Planning and Development Commission, 1975), living in a 10 square mile area, including a post office, school, about 5 grocery stores, 3 fish packing houses, and several other commercial buildings that service residents and oil companies in the area. The local economy is based on fishing and fish processing, raising cattle, and producing oil and gas.

The population of Cameron, like that of Hackberry, was not counted as a town in the 1970 census. However, the number of citizens in and around Cameron is estimated to be approximately 3,200 (Imperial Calcasieu Regional Planning and Development Commission, 1975). Cameron is the parish seat for Cameron Parish and is a main port for fishing in the Gulf of Mexico.

B.3-50

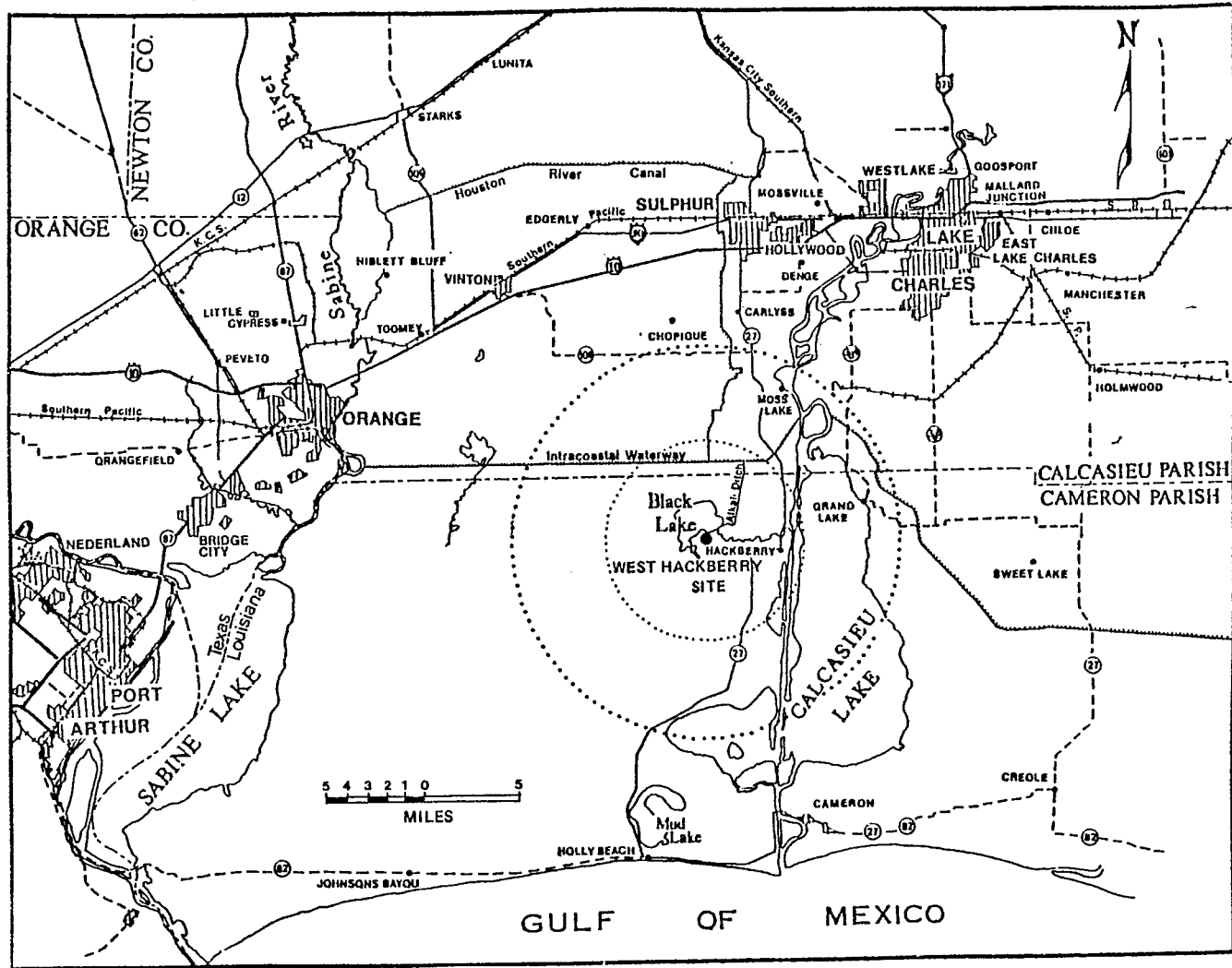

Figure B.3-14 Towns and Cities Around the West Hackberry Site

Holly Beach is a small resort village on the Gulf of Mexico, where lodges and guest houses outnumber the single family homes. It is an unincorporated community of less than 1,000 residents. (U. S. Census, 1970).

These three communities are too small to contribute substantial numbers of workers for the construction of the storage facility and its related pipelines. The cities of Calcasieu Parish would probably supply the majority of workers at the salt dome.

Sulphur is about 20 miles north of the West Hackberry site. It has a rapidly growing population. The census of 1970 registered 15,247 people, and a local census in 1972 recorded a population of 18,007. It derived its name from the sulphur mining that was conducted from the 1890's until 1924 on a site just outside the town. Many people who now live in Sulphur, work in the industries of Lake Charles.

Westlake is a town situated, as its name suggests, on the west side of the water body called Lake Charles. Its population is over 4,000 and, to a greater degree than its neighboring city of Sulphur, it depends on jobs provided by the metropolitan area of Lake Charles.

The construction of the oil distribution pipeline to Nederland would draw its labor supply from the major cities of Orange and Jefferson Counties. These include Beaumont, Port Arthur, and Orange, which were examined in the description of the region. These three major cities, together with their suburban areas, have a total population of over 300,000. Nederland, itself, has a population of 16,800, and is primarily a residential community. The Sun Oil Terminal lies in the city's extraterritorial area adjacent to the city limits. Many of the workers living in Nederland commute to jobs in Port Arthur and Beaumont.

Population Projections

The population of Cameron Parish grew by 10.7 percent between 1950 and 1960, and by 18.6 percent from 1960 to 1970. Population projections formulated by the Louisiana State University Division of Business and Economic Research indicate a growth rate of 13.5 percent for the decade of 1970 to 1980, bringing the population to a total of about 9,300. Assuming a constant growth offset by migration out of the parish, the population growth rate is expected to then rise to 14.1 percent between 1980 and 1990, bringing the population to a total of about 10,620.

The population projections for Cameron Parish formulated by the Louisiana State University team are slightly lower (less than 2%) than those formulated by the Imperial Calcasieu Regional Planning and Development Commission. This commission, however, has projected population growth for individual urban areas within the parish as follows:

	<u>1970</u>	<u>1980</u>	<u>1990</u>
Hackberry	1,335	1,490	1,640
Cameron	3,205	3,690	4,170

In this case, the "urban area" of Cameron includes the community of Creole, 14 miles east of Cameron, and the population expansion along the highway that connects the two communities.

The populations of Lake Charles, Sulphur, and Westlake combined are expected to reach a total of 118,600 by 1980, and 140,300 by 1990. This represents a growth rate of 22 percent in the present decade and of 18 percent in the next one.

The Beaumont-Port Arthur-Orange metropolitan area in Texas is expected to increase by 10 percent in the present decade, and 12 percent in the next, reaching a total population of 348,800 by 1980 and 390,000 by 1990.

B.3.1.8.3 Land Use Patterns

Land use plans for this area of Louisiana have been developed by the Imperial Calcasieu Regional Planning and Development Commission in conjunction with the Louisiana State Planning office. Present land-use designations for Cameron Parish reflect the fact that it is located in a coastal marsh. The distribution of total area in the parish is as follows:

undevelopable wetlands	567,329 acres	53.31%
public/semi-public lands*	229,235 acres	21.54%
water bodies	171,144 acres	16.08%
agricultural lands	85,710 acres	8.06%
residential, commercial, and industrial areas	10,713 acres	1.01%
TOTAL	1,064,131 acres	100.00%

*Includes the Sabine National Wildlife Refuge, the Lacassine Migratory Waterfowl Refuge, and the Rockefeller Wildlife Refuge and Game Preserve.

Hackberry itself is an unincorporated community, and neither it nor Cameron Parish has established zoning regulations to govern areas affected by the proposed project.

The land use plans for Hackberry in 1990, developed by the Imperial Calcasieu Regional Planning and Development Commission, are based on existing land use and projected population figures. They take into consideration the influences of industrialization patterns, flood prone areas, soil quality, and major highway arteries. These factors are particularly important in projecting the development of Hackberry because it is situated on a limited area of dry land bounded by wetlands on the north and south, Black Lake on the west, and Calcasieu Lake on the east. Total dry land area at Hackberry is approximately 10 square miles.

The Formula used to determine future land requirements has been based on the proportion of present population to land usage, and assumes a relatively constant growth pattern. The resulting delineation of various additional urban land requirements in 1990 is shown on Table B.3-10. The total additional acreage, 1990 urban acreage, and percent increase should be considered as maximum figures since the increase in population is only 22 percent. Also, it should be noted that the projected development of the community is dependent on the continued rapid expansion of industry in the area.

Due to the limited dry land area, a substantial part of future development is anticipated to occur in a strip along Highway 27 south of the present commercial area. The areas of land affected by the growth are shown in Figure Figure B.3-1.

B.3.1.8.4 Transportation

There are few major roads in the vicinity of Hackberry because of the extensive marshes and sparse population. Highway 27 is divided into two branches which run north and south along both sides of Calcasieu Lake, and connect the coastal towns of Cameron Parish. The west branch of the highway, which goes through the center of Hackberry, is the only roadway link between Hackberry and its neighboring towns and cities. There is more traffic between Hackberry and the cities north of it (primarily Sulphur, Westlake and Lake Charles) than between Hackberry and the coastal communities. A 1975 traffic survey indicated a daily average of 2,070 vehicles using the highway north of Hackberry, and only 810 using it farther south near its junction with coastal Highway 82.

Highway 27 passes within 4 miles of the oil storage site. Access to the site is provided by Route 390 and a parish road. Route 390 leads from Hackberry westward, and ends shortly after its junction with the parish road that goes to the storage site.

Waterways constitute a major transportation system in Cameron Parish. The interior portions of the parish can be reached only by the various canals and streams that form a network across the wetlands. The Intracoastal Waterway lies just north of the parish border, and is about four miles from the oil storage site. The site is located on the edge of Black Lake which is connected to Calcasieu Lake by Black Lake Bayou. This bayou is linked to the Intracoastal Waterway by Alkali Ditch. The relative positions of these waterways are shown in Figure B.3-15. Materials and equipment could be brought to the site via the Intracoastal Waterway and Alkali Ditch.

The railway and major airport services nearest Hackberry are 15 to 20 miles away in Sulphur and Lake Charles.

Since the salt dome lies in an area productive of oil and gas, there are pipelines that lie around the rim of the dome. These are mainly small ones, 4 and 6 inches in diameter. The pipelines that cross the top of the salt dome are those which have been used for the production of brine from the dome for use in the manufacture of chemicals.

B.3.1.8.5 Housing and Public Services

Due to the rural character of Cameron parish, much of the impact of the project would be experienced in the urbanized areas of Calcasieu Parish. While the health and protective services of Cameron Parish communities may be impacted by the use of the site and pipeline rights-of-way, it is Calcasieu Parish that would be primarily called upon to supply residential services to workers and their families.

Due to the limited availability of housing in Cameron Parish, workers and their families who might migrate to the region to work on the project at West Hackberry would probably settle in Lake Charles, which is only about 30 miles from the site, and in Sulphur, which is 21 miles from it. The availability of housing in Lake Charles is shown on Table B.3-10 of the regional description. The 1970 census registered a total of 4,165 housing units in Sulphur with a homeowner vacancy rate of 1.2 and a rental vacancy rate of 12.3.

Table B.3-10 1990 Projected Additional Urban Acreage of Hackberry

	<u>Acres</u>
Residential	17.1
Commercial-services	2.1
Industrial	49.7
Transportation-Communi- cation-Utilities	18.7
Institutional	16.9
Total Additional Urban Acreage	104.5
Total Existing Urban Acreage	169.0
Total 1990 Urban Acreage	273.5
% Increase 1970-1990	61.8

Source: Adapted from materials published by the Imperial Calcasieu Regional Planning and Development Commission.

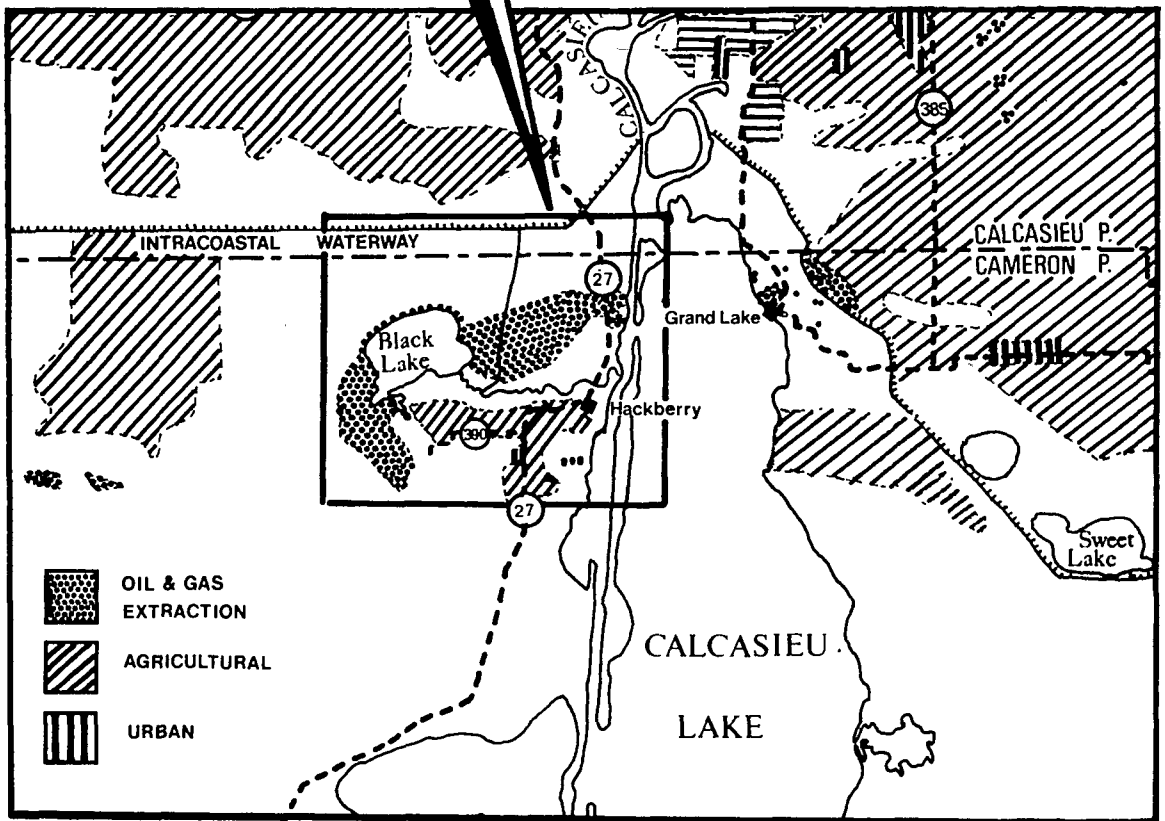
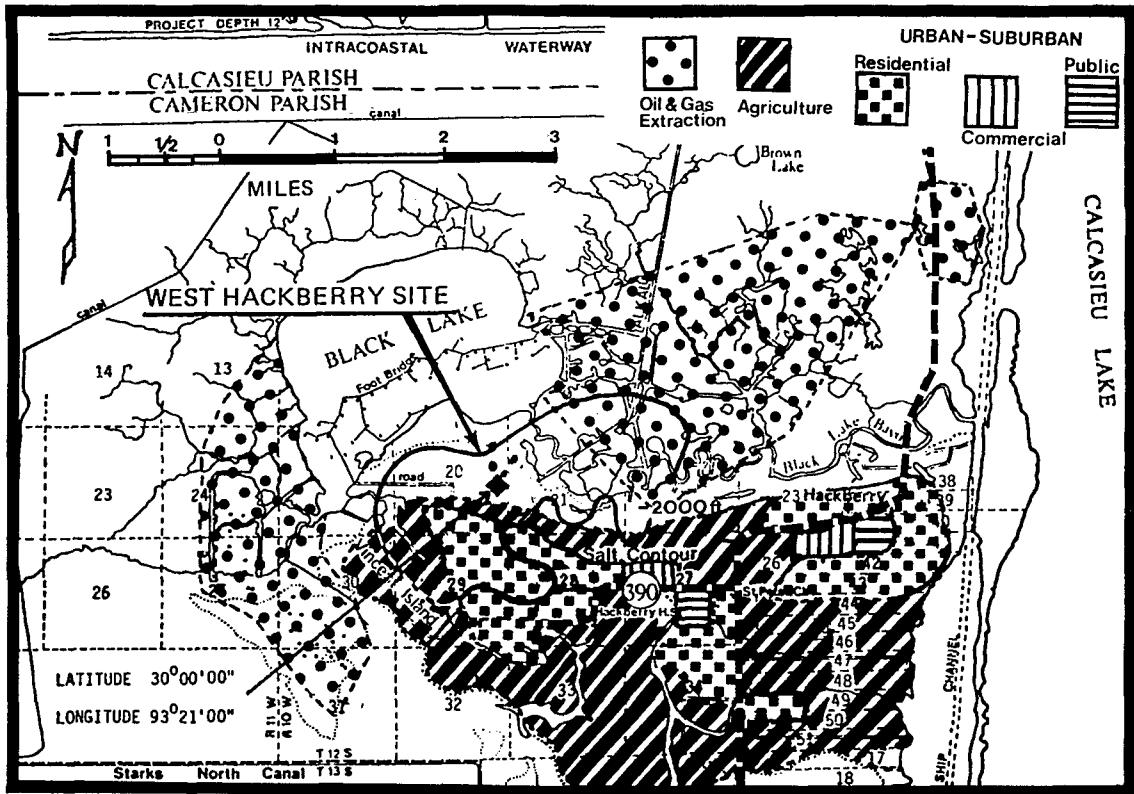

Figure B.3-15. Land Use Area at West Hackberry Site.
B.3-56

There is one school in Hackberry with 12 grades and a pupil enrollment of approximately 360 (Hackberry High School, 1976). In contrast, there are 44 public schools and 8 parochial schools in Lake Charles which together have a total enrollment of 24,692 pupils. Sulphur has 10 public schools, 2 parochial schools, and 6,940 pupils (Calcasieu Parish School Board, 1977).

While there is a doctor at Hackberry, the closest medical facilities to the site are at Sulphur. The hospitals at Lake Charles and Sulphur could be used by workers and their families who might migrate into the region for jobs at the proposed project.

Cameron Parish has a sheriff's department with a staff of deputies that hold full-time jobs in addition to their law enforcement duties. Three deputies and one special investigator live in the Hackberry area. Fire protection would be provided at the site for buildings and equipment. Auxiliary fire-fighting assistance would be available from the fire station at Hackberry.

B.3.1.8.6 Economy

The local economy of Hackberry is dependent upon fishing and processing the fish caught in Calcasieu Lake, production activities associated with oil and gas, and raising cattle.

Since Cameron lies along the shores of the Gulf of Mexico, fishing is an especially important industry for its people. Cameron ranked second among the nation's ports in terms of the volume of commercial fish landings in 1975. Over 390 million pounds of fish were harvested, for a total value of \$17,945,000 (NOAA, 1976). The large catch of menhaden accounts for the high volume and relatively low value of the fish. Most of the menhaden is processed into fish meal, fish oil, and fish solubles; the rest is used for bait. The menhaden are caught in purse seine nets which do not require many people to use them relative to the volume of fish caught.

Lake Charles is the largest community within commuting distance of the West Hackberry salt dome. In 1970, the labor force of the Lake Charles community was estimated at 26,442, approximately 2.3 percent of the total labor force in the state. Wholesale and retail trade and manufacturing for approximately 40 percent of the work force. At present, there are twelve business establishments employing more than 300 employees in the Greater Lake Charles area. The median income of all families was \$8,297 in 1970, 10.2 percent above the level for the state. About 45 percent of the households in Lake Charles had income levels between \$7,000 and \$15,000. In the fiscal year of 1969-1970, about 54 percent of the city tax revenue was from property taxes and 36 percent from sales taxes (Commerce, 1972).

B.3.1.8.7 Government

Since Hackberry is an unincorporated community, the basic public services for its citizens are administered on the Parish level. The parish is divided into districts which are separately taxed for the provision of such public services. Therefore, while there is no municipal tax, there are taxes assessed for the Hackberry Water District, the Hackberry Fire District, the Hackberry Garbage District, and the Hackberry Recreation District. In addition, taxes are levied separately for school districts and drainage districts, resulting in somewhat independent sections of the Parish. That portion of taxes for the roadways and general administrative services is levied uniformly throughout the Parish.

The total assessed value of Cameron Parish in 1973 was \$40,648,690. Of this, the value of real estate contributed 13 percent, personal property: 53 percent, and public service corporations: 34 percent. The proportionate value of real estate in the Parish is low compared to the state average, in which real estate accounts for 48 percent of the total assessed value.

The Cameron Parish Police Jury has jurisdiction over any construction within the Parish. Permits must be issued by the Parish prior to the erection or modification of buildings in flood hazard areas. They are also required for pipeline crossings of public roads and waterways. The Police Jury is composed of members from the various districts of the Parish, and meets once a month.

B.3.2 Alternative Site - Black Bayou

B.3.2.1 Land Features

B.3.2.1.1 Geomorphology

Black Bayou salt dome is located in the northwest corner of Cameron Parish, Louisiana, eight miles southeast of Orange, Texas and 12 miles south of Vinton, Louisiana. The dome is 18.5 miles north of the Gulf of Mexico and two miles south of the Intracoastal Waterway.

Black Bayou dome lies within the Gulf Coastal Plain Physiographic province. There is no topographic expression of the salt stock. The entire dome site is covered by marsh and a network of bayous and barge canals, the latter being constructed during oil exploration activities. These canals are arranged in radial and concentric pattern and are connected to the ICW by Black Bayou and the Black Bayou cutoff canal.

There are several wooded pimple mounds to the east and southeast of the site.

B.3.2.1.2 Geologic Structure

Black Bayou dome is a shallow piercement structure with steep, nearly vertical sides, circular horizontal cross section, and relatively flat top. The top of the salt is at 1,750 feet below sea level (Figures B.3-16 and B.3-17).

During the geologic history of Black Bayou dome the formations overlying the dome were stretched and faulted. The blocks of sediment were tilted and pushed up and aside by the rising salt core and then subject to erosion. This erosion decreased the weight of the sediment column above the dome which allowed easier movement of salt up through the sediments. Additional sediment then buried the faults and beds truncated by erosion. This model of the piercement process was proposed by Parker and McDowell (1955).

B.3-60

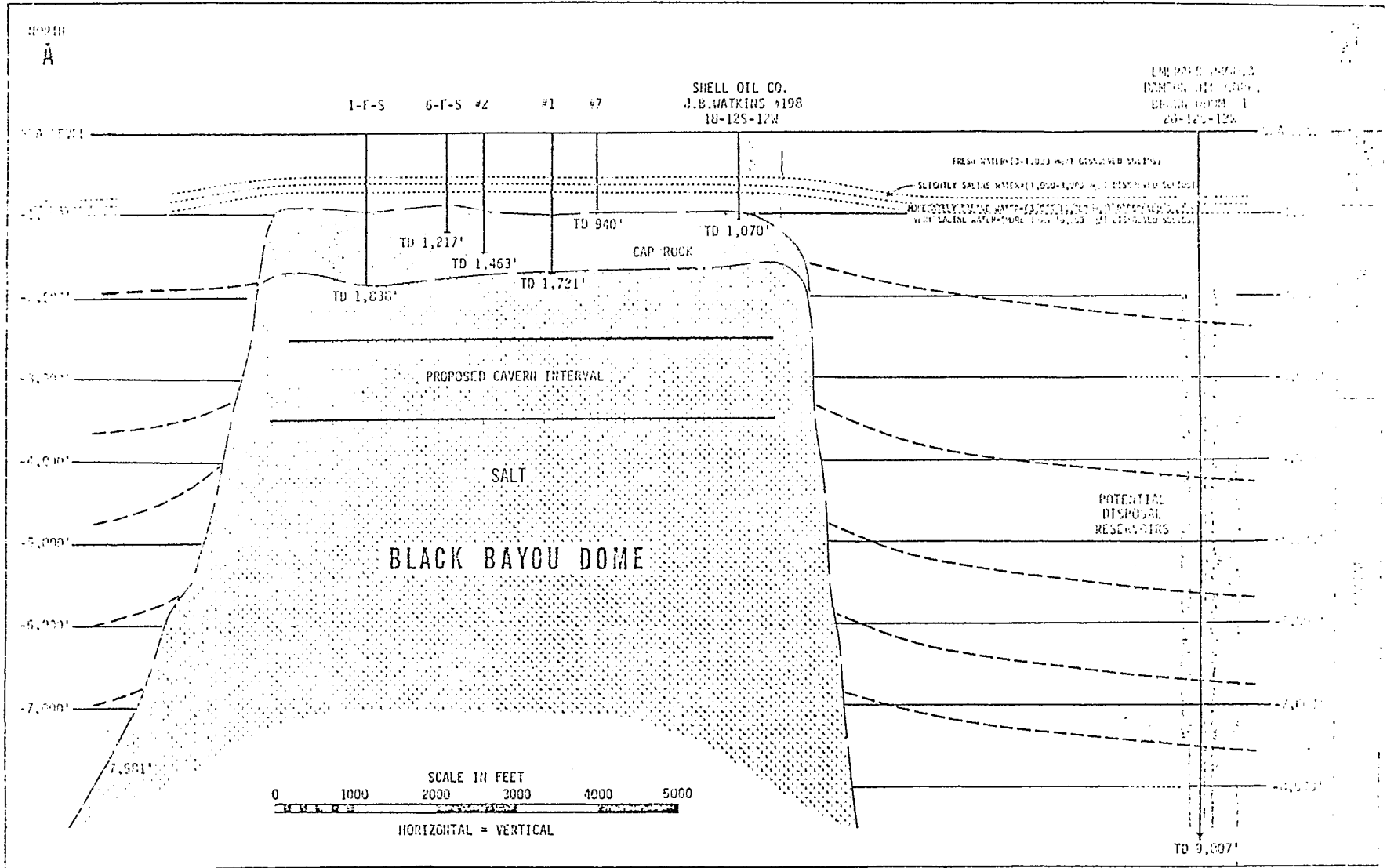

Figure B.3-16 Geologic Cross-Section of Black Bayou Dome (North-South).

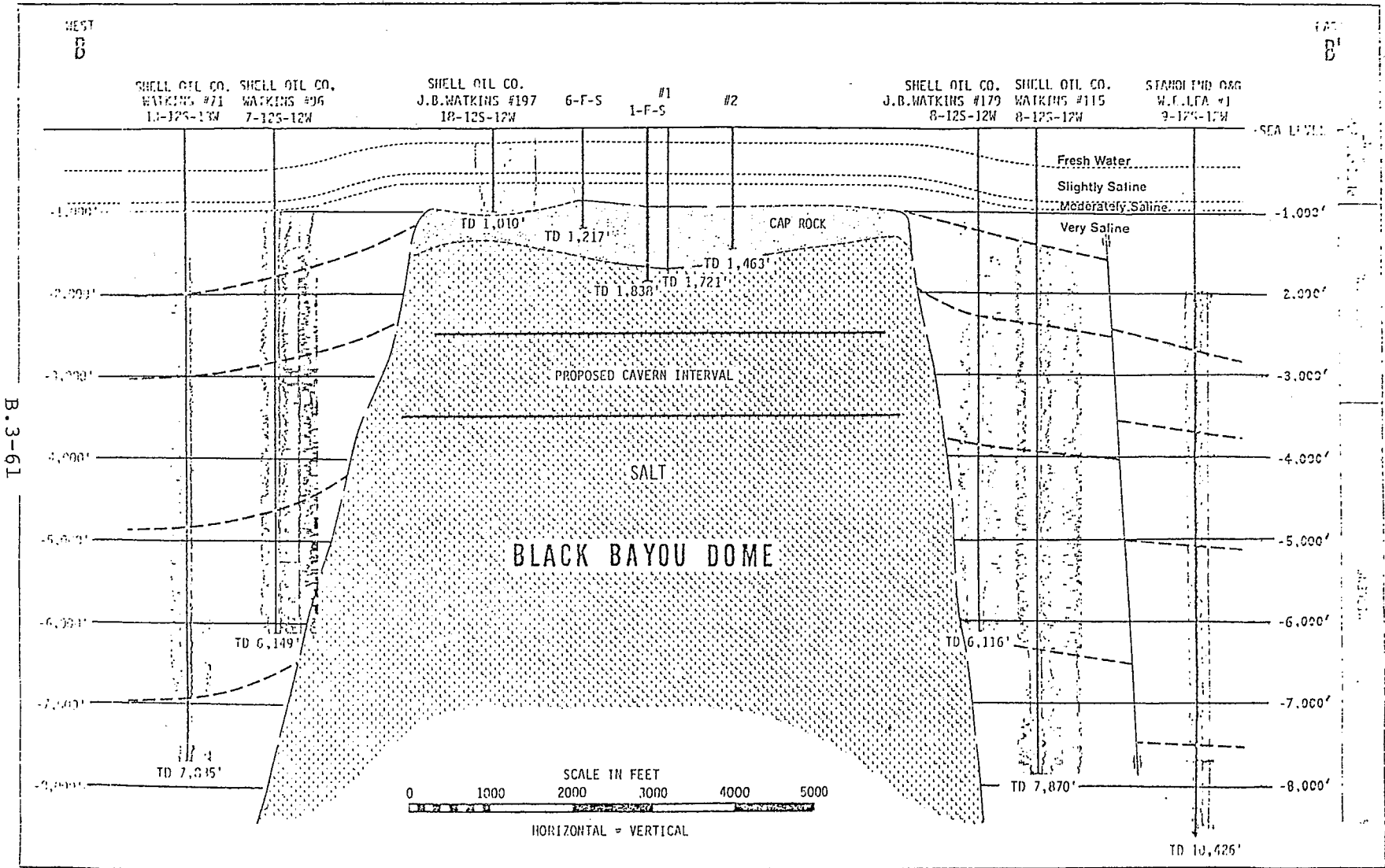

Figure B.3-17 Geologic Cross-Section of Black Bayou Dome (West-East).

Faulting within the Miocene and overlying Pliocene is extensive and complex. A structural geology map, contoured on a Miocene marker bed, shows three major easterly trending faults within the area (see Figure B.3-18). It is interpreted that these faults divide into several branches to the east. Additionally, a series of radial faults are interpreted on the east side of the dome*.

B.3.2.1.3 Stratigraphy

Due to the piercement process the stratigraphic sequence is more complicated than in areas where no salt structures exist. Smith and Reeve (1970) in their paper on salt piercement processes cite an unpublished cross-section of Black Bayou prepared by E. F. Middleton (see Figure B.3-19). Middleton theorized that the erosional surface of the tilted sedimentary blocks was Oligocene age whereas the sediments that buried this surface were Miocene. This unconformity occurs at a depth of 5,000 to 6,000 feet on the flanks of the dome. Sequences of poorly consolidated to unconsolidated marine, deltaic and fluvial clays, shales and sands comprise the stratigraphic section. Due to the proximity of Black Bayou to Vinton Dome the stratigraphic sequence described for Vinton could apply to Black Bayou except for thickness variations and the local effects of vertical displacement by the rising salt.

The shallowest known salt occurs at 1,035 feet in Freeport's No. 7 in the south half of Section 8; the deepest known salt top is at 8,553 feet on the northwest periphery of the dome in Shell's No. 48, J. B. Watkins in the southeast quarter of Section 6.

Approximately 723 acres are enclosed within the 2,000 foot depth to salt contour and about 813 acres are in the area enclosed by the 3,000 foot depth contour. The east-west axis of the dome above the 2,000 foot salt depth contour is slightly over 6,000 feet long while the north-south axis is just over 5,600 feet.

Based upon data derived from seven exploratory holes drilled by Freeport Sulphur Company, cap rock at Black Bayou is composed of an average (from top to bottom) of 76.3 feet of calcite (CaCO_3), 66 feet of gypsum ($\text{CaSO}_4 \cdot 2\text{H}_2\text{O}$) and an estimated 800³ feet of anhydrite (CaSO_4).⁴ No sediments from the surrounding formations were discovered within the cap rock.

*These faults do not extend into the salt.

B.3-63

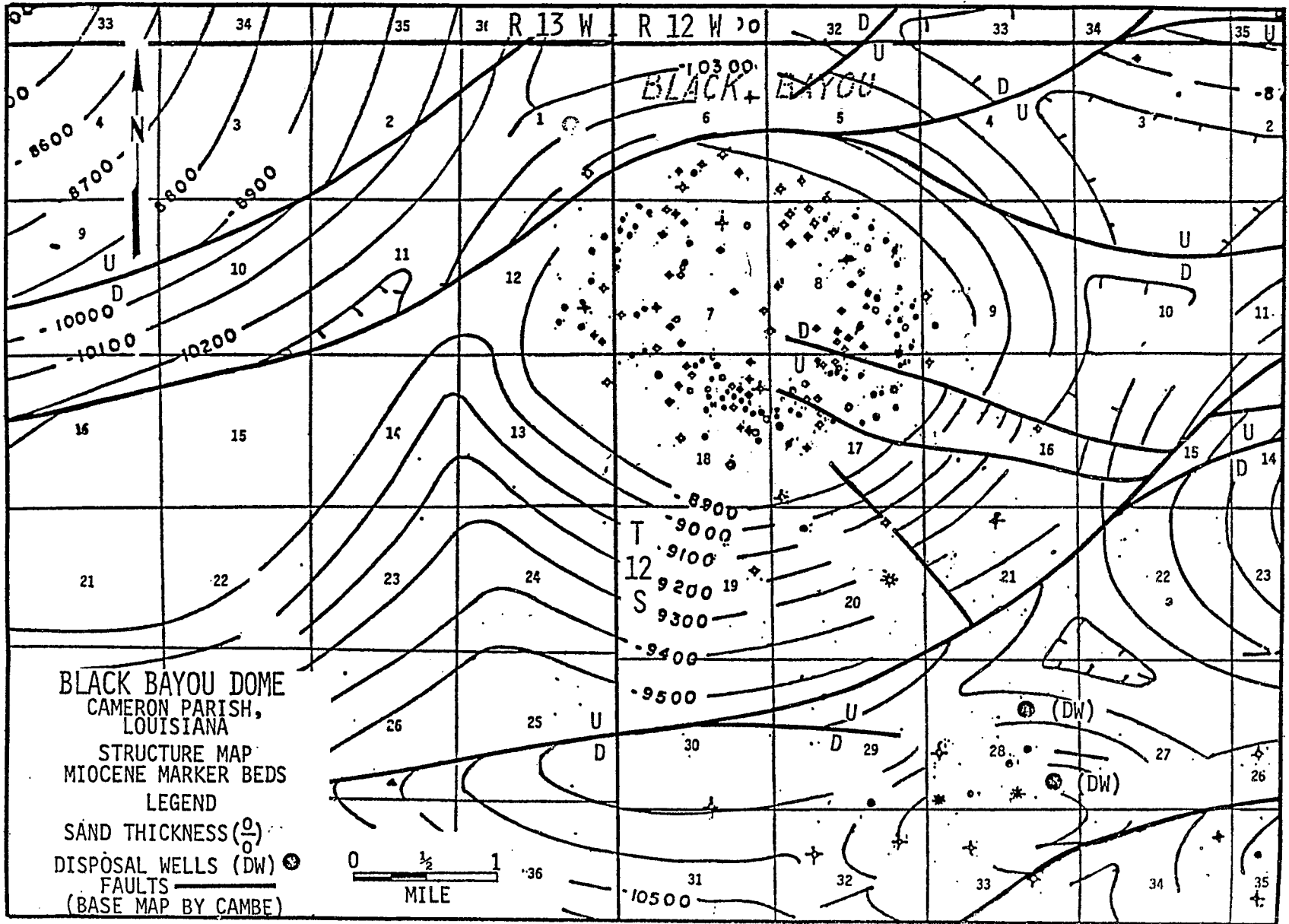

Figure B.3-18 Structure Map, Miocene Marker Beds - Black Bayou Dome

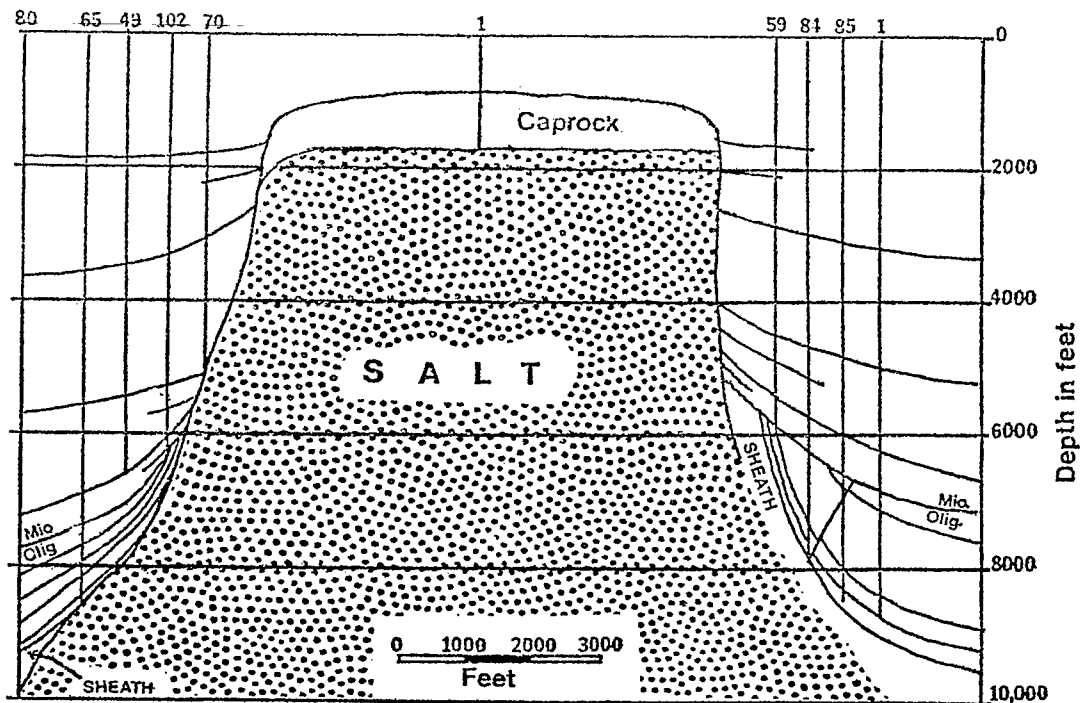

Figure B.3-19 Geologic Cross-Section of Black Bayou Dome showing the angular unconformity between Oligocene and Miocene sediments on the flank of the dome (Lower right hand corner).

Cap rock depth ranges from 881 feet at Freeport No. 6, in the southeast quarter of Section 6 (see Figure B.3-18 section locations), to a maximum depth of 1,369 feet at the southwest periphery of the dome. Cap rock apparently does not cover the entire dome inasmuch as a borehole near the center of the dome reported only the top of the salt with no cap rock; however, this may be an error in recording log data.

From the structure map it appears that the cap rock extends outward to cover the area underlain by the 2,000 foot salt contour, but holes drilled outside this contour area do not reveal any overlying cap rock.

B.3.2.1.4 Soil Characteristics

The soils at Black Bayou are known as the Harris Salt Water Marsh Association, (Figure B.3-20).

Harris soils, moderately saline phase, at the highest elevations and adjacent to ridges make up about 50 percent of the association. They have a very dark gray clay surface and a firm gray clay subsoil. Salt water marsh at the lowest elevations make up about 45 percent of the association. They have a soft organic and mineral mud surface layer 18 to 50 inches thick and a gray clay subsoil. Ridges of Harris, chenier variant and Harris, sandy substratum variant soils, and spoil banks make up most of the remaining 5 percent of the association, (USDA, 1971).

B.3.2.1.5 Mineral Resources

Oil and gas production has occurred all around the dome. First oil production was from Shell's No. 9 Watkins in 1929. Since that time, the greatest density of drilling has been on the southeast and northwest flanks. Interpretation of the salt structure map and geologic cross sections (see Figure B.3-21, B.2-16 and B.3-17) suggests that oil and gas occur on the flanks of the dome in Miocene or earlier sediments that are faulted or pinched out against the sides of the dome. Louisiana State Department of Conservation records reveal that oil or gas production occurs in numerous zones as shallow

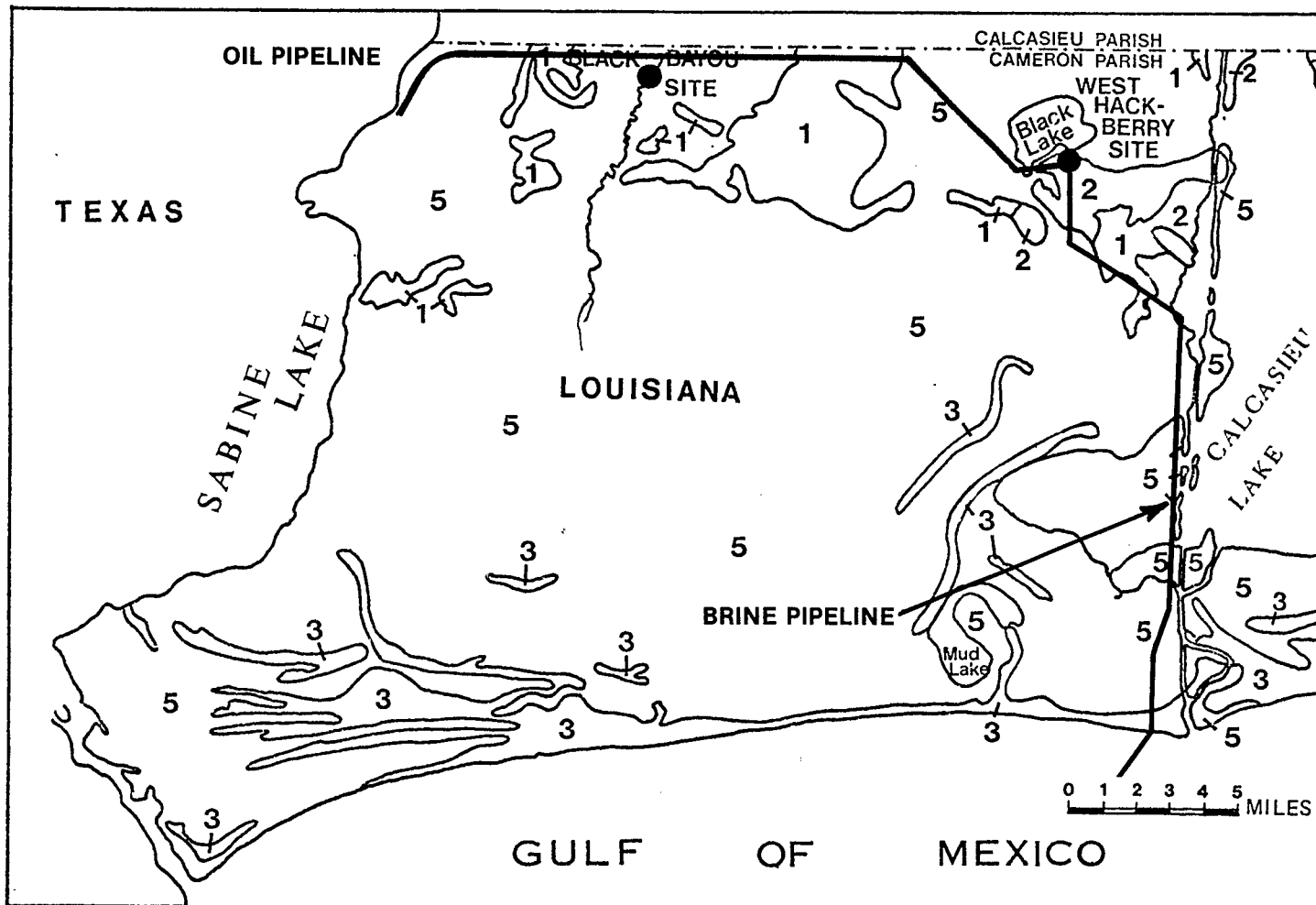

B.3-66

Figure B.3-20 SOIL DISTRIBUTION MAP FOR WESTERN CAMERON PARISH, LOUISIANA IN THE VICINITY OF BLACK BAYOU

- 1 Morey Beaumont Association - nearly level clayey and silty soils.
- 2 Crowley-Morey-Morwata Association - nearly level silty soils with clayey and silty subsoils.
- 3 Harris, Cheniere Variant - Palm Beach Association - clayey and sandy soils on low narrow ridges.
- 5 Harris - Salt Water Marsh Association - mineral and organic salt water marshland.

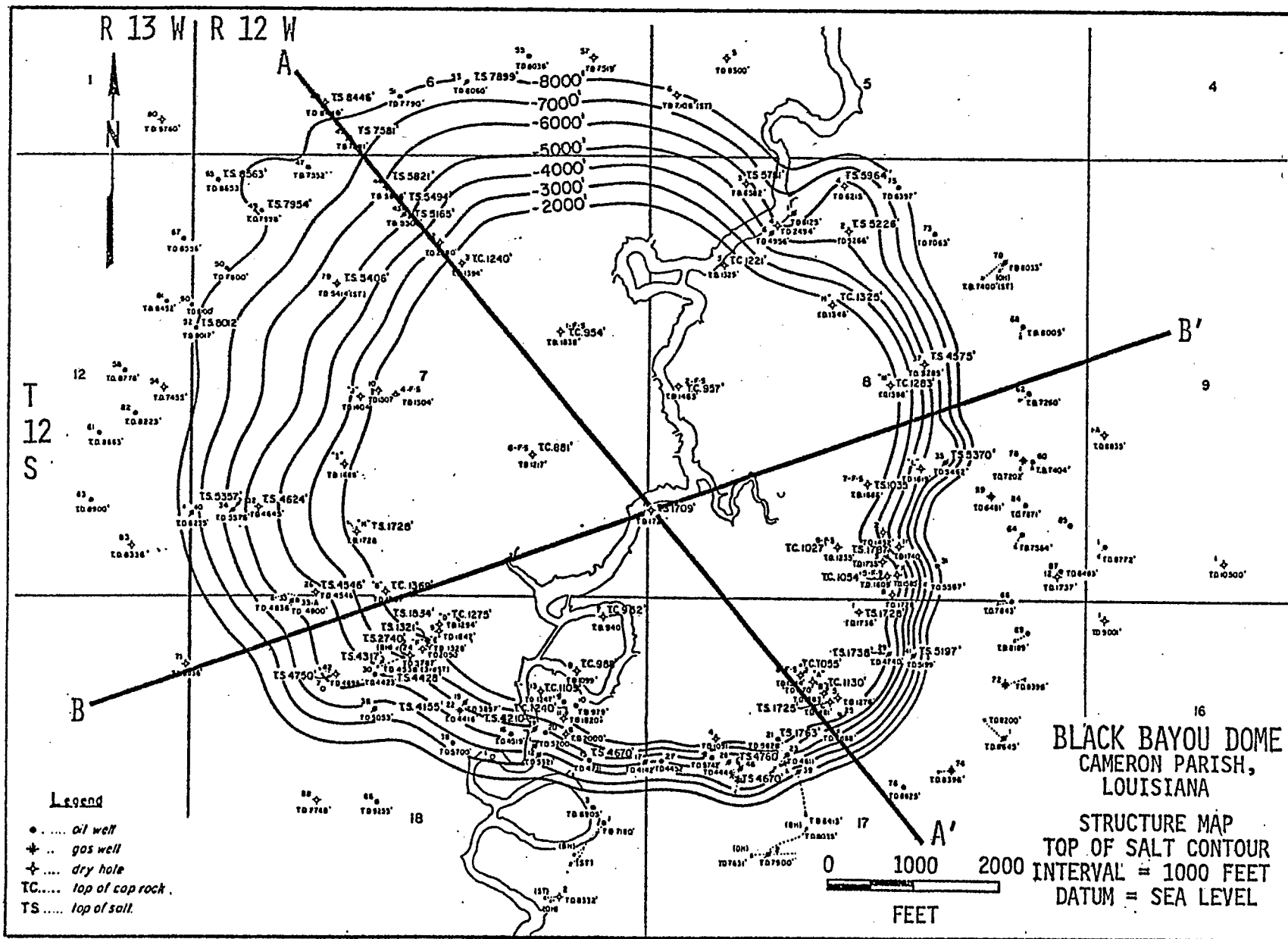

Figure B.3-21 Structure Map - Top of Salt - Black Bayou Dome

as 4,380 feet in Shell's No. 136 Watkins in Section 18 and as deep as 10,690 feet in Shell's E-2 Watkins in Section 36 (see Table B.3-11). No oil or gas is known to have been produced over the top of the dome in the area proposed for the storage facility.

No record of sulfur mining was found, but it is known that Freeport Sulphur Company drilled several exploratory holes into the cap rock.

No known salt mining of any kind has occurred at Black Bayou. Therefore, there are no existing caverns suitable for storage of crude oil.

Table B.3-11 Hydrocarbon Producing Intervals

1. Frio Sand, Reservoir A 7,872 feet to 8,190 feet in Shell #175 Watkins Sec. 7, T12S, R12W.
2. Marginulina "S" Sand 7,350 feet to 7,775 feet in Shell #85 Watkins Sec. 8, T12S, R12W.
3. Frio "I" Sand 7,915 feet to 8.350 feet in Shell #85 Watkins Sec. 8, T12S, R12W.
4. T₂ Sand, Reservoir B 7,000 to 7,300 feet in Shell #64 Watkins Sec. 8, T12S, R12W.
5. T₁ Sand, Reservoir B 6,909 feet to 6,944 feet in Shell #172 Watkins Sec. 17, T12S, R12W.
6. "O" Sand, Reservoir A 5,548 feet to 5,626 feet in Shell #137 Watkins Sec. 8, T12S, R12W.
7. "M" Sand, Reservoir C 4,950 feet to 5,050 feet in Shell #127 Watkins Sec. 18, T12S, R12W.
8. "M" Sand, Reservoir B 4,380 Feet to 4,498 feet in Shell #136 Watkins Sec. 18, T12S, R12W.
9. "M" Sand, Reservoir A 4,720 feet to 4,940 feet in Shell #91 Watkins Sec. 18, T12S, R12W.
10. Marginulina Sand 7,942 feet to 7,969 feet in J. W. Mecom's #1 Lea Sec. T12S, R12W.
11. 7,500 Foot Sand 7,385 feet to 7,545 feet in Shell #45 Watkins Sec. 6, T12S, R12W.
12. Camerian "A" Sand 10,636 feet to 10,690 feet in Pan Am Gulf #2 Land "E" Sec. 36, T12S, R12W.
13. Camerian "C" Sand 10,346 feet to 10,457 feet in Pan Am #2 Brown-Odom Sec. 28, T12S, R12W.
14. Camerian "B" Sand 10,206 feet to 10,287 feet in Pan Am #2 Brown-Odom Sec. 28, T12S, R12W.

B.3.2.2 Water Environment

The Black Bayou salt dome is located in Hydrologic Unit 9 of southwestern Louisiana within the estuarine part of the Sabine Basin. The location of Hydrologic Unit 9 is shown in Figure B.3-7. The dome lies primarily beneath marshland interlaced with a network of natural channels and manmade canals. The surface water system is underlain by clays which are nearly impervious to water passage. As at West Hackberry the annual rainfall is heavy, but the area generally experiences a moisture shortage for vegetation during the growing season (from February through November).

The surface water systems described in Section B.3.2.2.1 represents the primary source of leaching/displacement water as well as the primary site for brine disposal. The subsurface water systems discussed in Section B.3.2.2.2, constitutes a secondary source for water.

B.3.2.2.1 Surface Water Systems

Hydrologic Unit 9 has already been described in Section B.3.1.2.1. The general arrangement of the surface water bodies in the vicinity of Black Bayou is depicted in Figure B.3-22.

Black Bayou and Related Water Bodies

Black Bayou is approximately 19 miles long with a mean width of 170 feet and a depth of 3 feet (Barrett, 1970). This bayou constitutes the primary source of leaching/displacement water at the Black Bayou site. As indicated in Figure B.3-22. bayous intersects the ICW approximately 2-1/2 miles north of the dome via three channels, two of which appear to be manmade. To the southwest the bayou empties into the East Pass of the Sabine River just upstream of Sabine Lake. Two tributaries, Right Prong and Greens Bayou, join Black Bayou between the dome site and the Sabine River. The Bancroft Canal intersects the bayou to the east of the dome. Approximately 4 miles south of the dome site lies Starks Canal, which forms the northern boundary of the Sabine National Wildlife Refuge. The western boundary of the refuge coincides with the north-south segment of the same canal extending southward from Right Prong. At the southwestern corner of the refuge (approximately 10 miles south of the dome), this segment of Starks Canal intersects Willow Bayou Canal/Central Canal which extend from east to west. Three miles further south Starks Canal turns to the west toward Sabine Lake. In the coastal area Hamilton's Lake and Old North Bayous are located between the Sabine National Wildlife Refuge and the Gulf of Mexico. All available data concerning the physical dimensions of all of the water bodies noted are summarized in Table B.3-12.

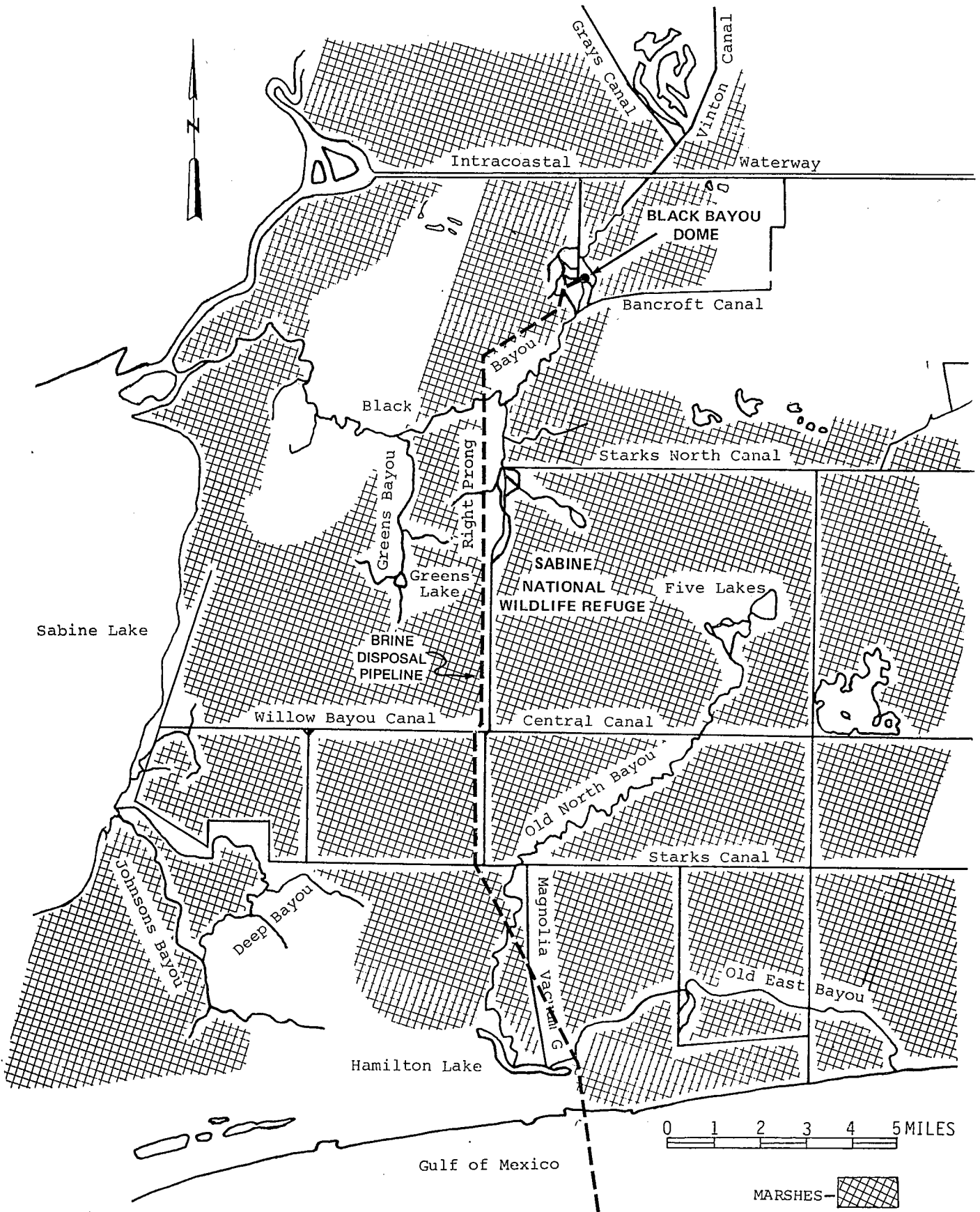

Figure B.3-22 Black Bayou Surface Water System
B.3-71

Table B.3-12 Surface Water Bodies in the Vicinity of Black Bayou Dome

Water Body	Distance from Dome (miles)	Direction from Dome	Direction of Flow	Length (mi)	Width (feet)	Depth (feet)	Area Sq. Mi.
Intracoastal Waterway	2.2	N	E*	22.0	300	8.0	5.95
Black Bayou	zero	SW	SW	18.7	170	3.0	0.60
Right Prong (Black Bayou)	4.1	SW	N	2.8	60	1.5	0.03
East Fork Right Prong	5.3	SW	N	-	-	-	-
Bancroft Canal	.7	E	I	6.3	40	4.5	0.05
Greens Bayou	6.5	SW	N	4.4	30	2.0	0.03
Starks Canal	4	S	I	21.6	40	2.5	0.16
Willow Bayou Canal	11.5	S	-	6.9	40	3.0	0.05
Old North Bayou	13	S	-	12.9	30	1.5	0.07
Hamilton Lake	16	S	-	-	-	1.5	0.97

* Generally Eastward Flow

State water quality standards for Black Bayou are provided in Appendix D. As indicated by these standards the bayou is to be used for secondary contact recreation and for the propagation of fish and wildlife. The bayou is classified as tidal by these standards. Records of the Sabine National Wildlife Refuge show a mean salinity of about 3.2 ppt for Right Prong. Salinity data for Black Bayou have not been located.

Coastal Waters of the Gulf of Mexico near Black Bayou

In order to reach a depth of 30 feet, the brine diffuser site would be located at least 5 miles offshore. The bottom composition and salinity characteristics are very similar to those previously discussed for the West Hackberry site.

Surface currents in the area are variable, being strongly affected by winds, tides, and other conditions. Mean surface currents 15 miles southeast of the disposal area, as indicated by the current rose in Figure B.3-12 tend to set to the west with a drift of 1 knot (Bureau of Land Management, 1975d). The diurnal tidal range is approximately 2 feet. The wind rose shown in Figure B.2-11 indicates that the most likely wind is from the southeast at 11.6 knots. Additional detailed oceanographic data are provided in a related report (NOAA, 1977). Finally, a detailed description of site specific physical oceanography determined during a field study for this EIS, is presented in Appendix U.2.

B.3.2.2.2 Subsurface Water System

The base of fresh ground water in the Black Bayou dome area is -500 feet msl (mean sea level). Slightly saline water occurs in the approximate depth interval of -500 to -900 feet msl. The precise depth of the Chicot aquifer is not known at Black Bayou dome. A driller's log of well Cu-86 at Cameron Farms, 5 miles east of the dome, indicates the "700-foot" sand of the lower Chicot occurs between 718 and 838 feet below the surface. The salinity of ground water at various depths tested in this well are as follows:

<u>Sand Interval Tested</u>	<u>Cl (ppm)</u>	<u>Dissolved Solids (ppm)</u>
525-535 feet	171	531
631-641 feet	364	908
806-812 feet	1250	3140

The strongest influence on local ground water movement is the regional effect of ground water pumping at Lake Charles, Louisiana. The dome of depression in the "500-foot" sand of the Chicot centered on Lake Charles is shown in Figure B.2-5 (Harder et al, 1967). Black Bayou dome is located on the southwestern edge of the cone of depression and water in the

Chicot at the dome moves northeastward toward the pumping center. Based on water levels in the "500-foot" sand in 1965 the northeastward rate of ground water movement currently is approximately 200 feet per year at Black Bayou.

In the early 1900's, before significant development of ground water resources in southwestern Louisiana, the potentiometric surface of the Chicot aquifer (the level to which water would rise in a well open to the entire aquifer) was at or above land surface in the Black Bayou area (Jones, Turcan and Skibitake, 1954). In 1965 the water level had dropped to approximately 30 feet below land surface. Currently local ground water use is restricted to a few wells 5 and 6 miles east of the dome. Due to the marsh conditions and limited fresh ground water supplies, no ground water use is developed within 5 miles north, west, or south of the site.

B.3.2.3 Air Quality

B.3.2.3.1 Existing Air Quality

Since onsite monitoring has not been conducted at the proposed Black Bayou expansion site, the regional air quality levels established in Section B.2.3.3 are used to predict the existing air quality at the Black Bayou site. Based on these data, the ambient concentrations of NHMC and photochemical oxidant are predicted to be high and might exceed the existing standards. All other pollutants are expected to be in compliance with the applicable standards.

B.3.2.3.2 Projected Air Quality

Projection of SPR activities at Black Bayou indicate that the nitrogen oxides, carbon monoxide, and particulate concentration are expected to be in compliance with standards in the following 10 years. However, sulfur oxides and NMHC are expected to exceed the ambient air quality standard due to the increased marine terminal operation. The high NMHC concentration would result in the projections of oxidant level exceeding standards.

B.3.2.4 Background Ambient Sound Levels

Background noise levels in and around the alternative SPR site at Black Bayou salt dome expansion are typical of a secluded essentially flat area. The area is similar in geography and surrounding land use to that described for the SPR region. Noise assessment of ambient levels for the region are contained in Section B.2.4.

B.3.2.5 Species and Ecosystems

B.3.2.5.1 Environmental Setting of the Displacement/Leaching Water System

The water supply system would result in extensive alteration (see Figure A.5-2) to the eastern side of Black Bayou across from the main Shell Oil Company storage tanks and a barge docking location which allows barges to fill with oil from these tanks. The point where the intake structure and sump would be placed is immediately to the north of an east-west trending marsh channel. The water line would pass for only a short distance east in fresh to intermediate marsh and along the southern end of a stand of trees to the 40,000 bbl surge tank. From the surge tank a line would pass south across the marsh channel and in marsh to the central plant. Organisms present along the water supply system components include fresh and intermediate marsh plants and animals as discussed in Sections B.2.5.2.1. Characteristics of Ecosystems in Western Cameron Parish; B.2.5.2.5, Terrestrial Vertebrates of the Texoma Region; B.2.5.4.2, Important Commercial Species of the Region - Animals; and B.2.5.5, Important Recreational Species of the Area. Aquatic organisms likely to be in the channels are also discussed in the above sections. The woods to the north of the surge tank are on a slight ridge which has been called "Goat Island" or "Bird Island" and contain mainly deciduous trees. Oaks would be typical for the conditions present. The marsh and water channels near the water lines probably contain salt-tolerant freshwater fish, insect larvae, oligochaetes, mollusks, crustaceans, birds, mammals, reptiles, phytoplankton, zooplankton, epiphytic and periphytic algae, and perhaps benthic algae. There are birds and small mammals in the stand of woods.

B.3.2.5.2 Environmental Setting of the Brine Disposal System

The brine lines would pass from the wellheads along the same paths as the oil and water supply pipelines. These lines would pass through marsh and water channels in the marsh near the water surge tanks and the central plant. The narrow tree-bearing ridge mentioned in connection with the water supply system would be located in the storage cavern field. Organisms present would be of the same types as those discussed in relation to the water supply system in Section B.3.2.5.1. From the central plant area the brine line (See Figure B.3-22) would pass to the southwest past the Shell main plant along a water course

and then pass more to the south across expanses of water connected to Black Bayou, roads, marsh, and the Bayou itself before intersecting with Transcontinental Gas Pipeline Company's pipeline right-of-way leading south through the Sabine National Wildlife Refuge, across the beach and into the ocean floor. In the Sabine National Wildlife Refuge, the brine pipeline would pass through first brackish, then intermediate, then brackish, then intermediate, and finally brackish marsh again before coming to the shore of the Gulf of Mexico. Along its course toward the Gulf, the brine pipeline would cross Black Bayou a second time, old North Bayou near the southern boundary of the wildlife refuge and Old East Bayou near Ocean View Beach. From the beach the pipeline would continue in the ocean bottom to a required diffuser depth of 20 feet. The types of marsh plants and animals present along the route from the central plant are discussed in Sections B.2.5.2.1, B.2.5.2.5, B.2.5.4, and B.2.5.5 in detail. Aquatic and marine organisms are also discussed in those sections. A rich panoply of marsh and chenier plants, waterfowl, fish, shellfish, furbearing mammals, alligators, and other organisms are present in the vicinity of this pipeline route. Sandy cheniers (ridges) along the coast in this area typically are covered with Huisache, cactus, and brush or groves of hackberry, china-berry, and prickly ash (Lane and Tveten, 1974).

B.3.2.5.3 Environmental Setting of the Site

The central plant location at the southeast corner of the storage site is near the roads and main office of the Shell Oil Company main plant. The general area where the storage caverns and associated facilities are located is in the midst of a vast maze of canals running in marshland. A peripheral road nearby encircles the storage area. This road has numerous connections to well pads and some to spur roads. The roads are shell and are elevated on fill. Scattered trees are present in some areas of slightly higher elevation and there is a stand of trees in the storage cavern field, as mentioned previously. The types of organisms present have already been cited in connection with the water supply system (Section B.3.2.5.1).

B.3.2.5.4 Environmental Setting of the Oil Distribution System

The oil supply and distribution line is proposed to be buried in the Black Bayou Cutoff, a canal which passes nearby due north from the site through the surrounding canals and wetlands to the Intracoastal Waterway where it would join the ESR pipeline for West Hackberry. The route from the ICW westward is identical with the same segment from this point already described for the West Hackberry oil distribution system (Section B.3.1.5.4). The organisms to be found along this route are additionally discussed in Section B.2.5.2.2 (Characteristics of Ecosystems in Western Calcasieu Parish) and B.2.5.2.3 (Characteristics of Ecosystems in Orange County). Along the Black Bayou Cutoff portion of the route aquatic species present around the dome itself should be present. These were cited in Section B.3.2.5.1 (Environmental Setting of the Displacement/Leaching System). The banks of Black Bayou Cutoff are lined by trees over much of its extent toward the ICW from the proposed storage site. Farther away from the Cutoff banks, marsh and open water generally hold sway. The pipeline route along the ICW runs mainly across marsh, cultivated and cleared lands, and spoil banks. Within Texas the pipeline would pass through a mosaic of marshland types, bayous, channels, crop and pasture land, different woody associations, and the Neches River. The Sabine River would be crossed near the western end of the ICW in Louisiana to admit the pipeline into Texas.

B.3.2.6 Natural and Scenic Resources

Black Bayou is a relatively high quality marsh habitat. The Shell Oil facilities already present in the marsh have been well constructed and are operated in such a manner that this marsh quality is maintained. Black Bayou is unique in that within a relatively small area there exists a large complex of open water canals and protected inlets into the marsh grass. This type of habitat attracts many waterfowl, both in terms of number of species and total individuals. The birds find protection within the marsh grass while using the shallow open waters for feeding.

The proposed brine line from Black Bayou would pass through an 11-mile portion of the Sabine National Wildlife Refuge. It would follow an existing Transcontinental Gas Pipeline Company right-of-way for most of the distance. This pipeline corridor is adjacent to the western edge of the large fresh water impoundment in the central portion of the refuge.

B.3.2.7 Archaeological, Historical and Cultural Resources

There are three recorded archaeological sites in close proximity to the proposed Black Bayou oil and brine pipelines. The first location is a small shell midden complex approximately 150 feet in length. This midden is within 500 feet of the brine pipeline route in the vicinity of Hamilton Lake, approximately one mile from the Gulf. Another site in the vicinity of the brine pipeline is within 2000 feet of the route and has indications of having been previously disturbed (Thomas, et al., 1977). The third location is also a shell midden located within 200 feet of the ESR oil pipeline route adjacent to the Sabine River in Louisiana. Black Bayou dome was randomly sampled during a cultural resources survey and although no sites were located, deep testing would be recommended to affirm that no sites were present in the proposed storage area (Thomas, et al., 1977).

No sites listed in the "National Register of Historic Places" (National Park Service, 1977), were found to be in the vicinity of the Black Bayou dome or proposed oil and brine pipelines. There is one shell midden, mentioned in Section B.2-7, which has been proposed as a National Register site. It is located 1-1/2 miles from the ESR oil pipeline route south of the Sabine River in Louisiana.

B.3.2.8 Socioeconomic Characteristics

B.3.2.8.1 History and Cultural Patterns

When settlers arrived in Cameron Parish, the Indians who had once lived there had either died out or had left. People made their homes along the bayous near the Gulf Coast and the shores of Calcasieu Lake. The vast wetlands in the interior of the Parish remained a wilderness, the domain of hunters and trappers.

Near the proposed brine pipeline right-of-way is a community called "Johnsons Bayou." It was named for Daniel Johnson and his family, who were the first settlers there. Other families joined them, and a school and post office were established in the late 1800's. Just north of the town is Hamilton Lake, named for John Hamilton who moved there around 1850. The settlers made a living by raising cotton and cattle, and as the communities grew, they would add churches, blacksmith's shops, and stores. Ships would stop along the coast and buy fur pelts and alligator hides, wild fowl packed in ice, and cotton.

Oil was discovered at the Cameron Meadows oilfield in 1929 when a trapper who was lighting a match for his cigarette, ignited a patch of oil on the ground. An economic oil boom resulted, during which a whole village was built on wharves over the marshes, to house the workers at the oilfields (Cameron Parish Home Demonstration Club, 1966).

People of this area continue to make a living in the oil and gas fields and by raising cattle. A large proportion of the residents are of families that have lived there for generations. Hunting, trapping, and fishing are the major forms of recreation. A short distance east of Johnsons Bayou is Constance Beach which has a number of vacation homes and lodges for tourists who come to the area.

B.3.2.8.2 Population

This alternative site for the proposed petroleum storage project is located in a rural section of Cameron Parish. The site itself lies in a marshland that has been used extensively for oil and gas exploration. The road to the site travels along Gum Cove Ridge through a small settlement known as Cameron Farms. Along the ridge and at Cameron Farms there are about 10 to 20 buildings.

The proposed pipeline to carry brine from the solution cavities to the Gulf of Mexico would follow a gas pipeline right-of-way along the Burton-Sutton Canal south and cross Highway 82 near a community called Johnsons Bayou (see Figure B.3-23). The community is unincorporated, and is strung out along the highway for a distance of about 10 miles. There is a school, a few churches and cemeteries, and several commercial establishments. Traffic counts along Highway 82 in the vicinity of Johnsons Bayou registered an average of 700 to 800 vehicles per day. The population of Johnsons Bayou was about 700 in 1970 and is projected to reach approximately 900 in 1980 and 1,150 in 1990 (Imperial Calcasieu Regional Planning and Development Commission, 1975).

B.3.2.8.3 Land Use Patterns

The land in the immediate vicinity of the Black Bayou site has been designated as an area for mineral extraction (Imperial Calcasieu Regional Planning and Development Commission, 1974). The land surrounding the site on its north, west, and south boundaries is marshland, and not suitable for development. The eastern side of the site is connected to Gum Cove Ridge, a natural topographic rise which is used for farming and grazing cattle.

The brine pipeline to the Gulf of Mexico would cross the marshlands and pass through the Sabine National Wildlife Refuge, along an existing right-of-way for the transport of natural gas. The refuge covers 138,942 acres, or 13 percent of the total area of the Parish.

Gum Cove Ridge, which is used for access to the site, is listed as one of several potential state park sites in Southwestern Louisiana by the State Parks and Recreation Commission (1974 publication). It was selected because of the presence of pimple mounds and prairie marsh, but is only one of 167 potential sites having commemorative, preservation, or recreational significance in Louisiana.

Along the coast in the area where the brine pipeline would enter the Gulf waters, is Ocean View Beach. Just east of this area is a small cluster of houses known as Constance Beach, and further east is Peveto Beach. There are a number of lodges along the roadways in this area, offering short-term accommodations for people who use the beaches in this area. As the population of Lake Charles, Sulphur, and other regional cities grow, these beaches will be increasingly used as recreational areas.

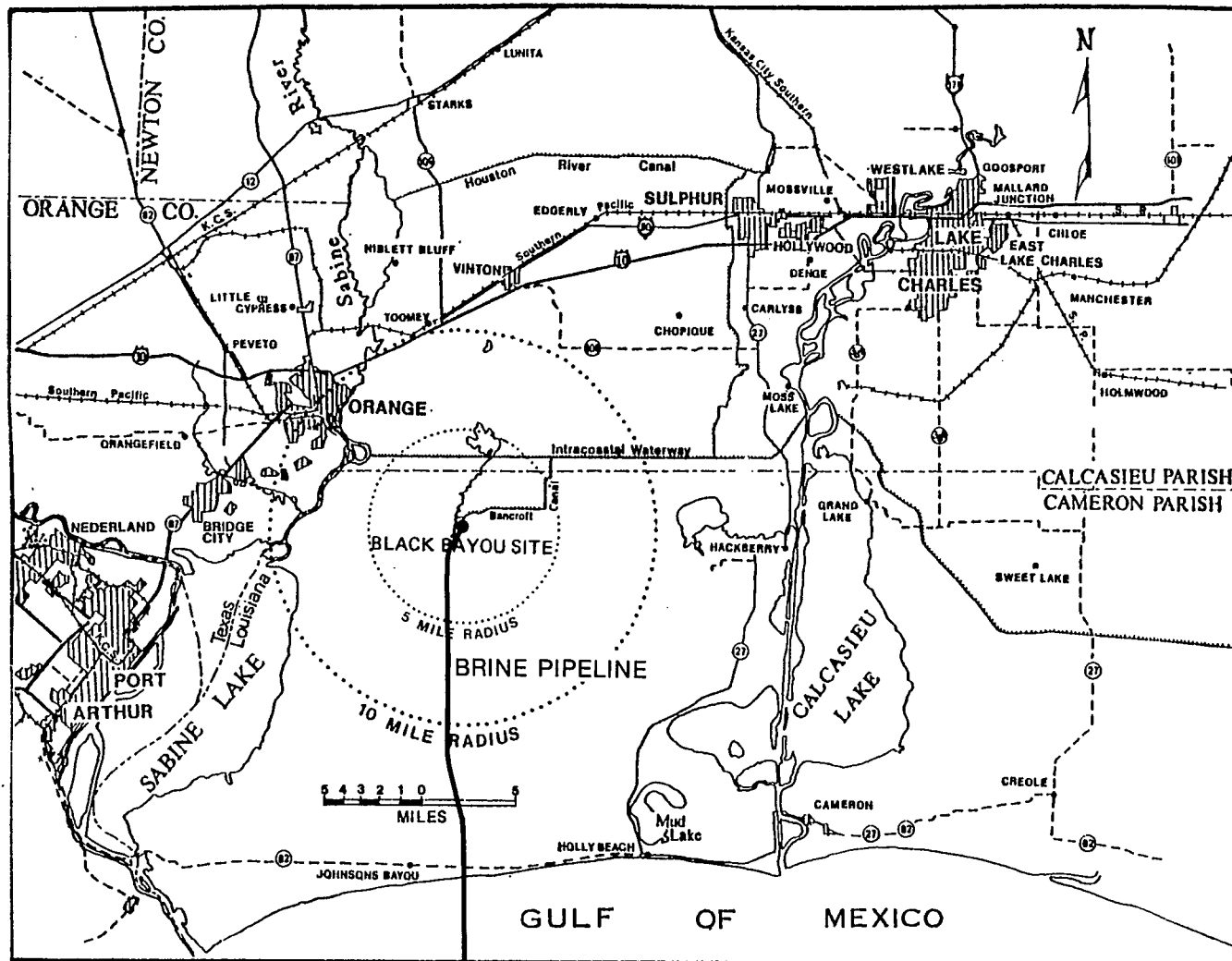

Figure B.3-23 TOWNS AND CITIES AROUND THE BLACK BAYOU SITE

B.3.2.8.4 Transportation

The Black Bayou site is in an isolated part of Cameron Parish. It is about 20 miles from the nearest main highway, Interstate 10, and from the nearest town. Workers traveling to the site would turn off Interstate 10 at Vinton and travel south on Route 108 and an unnamed road (which is not State maintained). At the point where this road crosses the Intracoastal Waterway, there is a ferry. A traffic count conducted just south of the ferry in 1971 registered an average of 140 vehicles daily (Louisiana Department of Highways, 1971). The parish road, which must be taken to reach the site access road, ends about 4 miles past its junction with that road. The access road is built on land fill and material dredged from the construction of the Bancroft Canal. The site itself is surrounded by wetlands which are reached by canals rather than roads.

The Intracoastal Waterway lies about two miles north of the Black Bayou site. A canal, Black Bayou Cutoff, has been dredged from the Intracoastal Waterway to the site and connects with a network of smaller channels that form a network around the salt dome. These waterways are currently used for access to the oil wells around the dome.

The nearest airports are those at Lake Charles and Port Arthur. The Southern Pacific Railway passes through Vinton, 20 miles north of the site.

B.3.2.8.5 Housing and Public Services

Since there are no towns of appreciable size within a distance of 10 miles from the site, workers for the project would commute to the Black Bayou site, probably from Lake Charles, Sulphur, and Orange. These cities would provide schools and medical facilities for the workers families. (Detailed information regarding housing and public services in the area is presented in Section B.2.8.5 and Section B.3.1.8.5). Firefighting equipment and security guards would have to be provided at the site since it is under the jurisdiction of Cameron Parish, but is not readily accessible to the parish communities that house these services.

B.3.2.8.6 Economy

The major urban area located near Black Bayou is Orange, Texas, also located north of the site is the town of Vinton, Louisiana. The median family income in 1969 in Vinton was \$7,402 and Orange \$8,839 (Census 1970). An examination of the major corporations located in Orange indicates the heavy dependence of the community on the petrochemical industry, and other industries requiring the use of oil and gas products such as carbon black production.

The town of Vinton is partially dependent upon the oil and gas production industry, and also serves as a commercial center for the rice-farming region of western Calcasieu Parish. Many retail businesses in Vinton are largely supported by the influx of persons who are attracted to the local Delta Downs racetrack.

B.3.2.8.7 Government

The Black Bayou site lies in Cameron Parish, and the construction and operation of facilities there, would be within the jurisdiction of the Cameron Parish Police Jury. Communities within Cameron Parish which would be affected by the use of the Black Bayou site are Cameron Farms, which lies along the road to the site, and Johnsons Bayou, which lies along the brine disposal pipeline route. Neither is an incorporated community, and of the two, only Johnsons Bayou has a separate specialized taxation assessment district for public services--the Johnsons Bayou Recreation District. Governmental services for these communities are administered by the Parish, and a more detailed description of Parish authority and finances is given in Section B.3.1.8.7.

B.3.3 Alternative Site-Vinton

B.3.3.1 Land Features

B.3.3.1.1 Geomorphology

Vinton salt dome is located in Southwestern Louisiana and in southwestern Calcasieu Parish. It is 3.5 miles southwest of the town of Vinton and is about halfway between Lake Charles, Louisiana and Beaumont, Texas.

Vinton Dome lies within the Gulf Coastal plain physiographic province. Vinton dome is a characteristically central sunken type dome such as Palangana and West Columbia (Thompson and Eichelberger, 1928). The sink contains a fresh water lake known as Ged Lake. The lake, which is only 3 feet deep, is on a mound which is about 30 feet above sea level and 15 feet above the surrounding featureless plain.

The Vinton drainage canal is one mile east of the dome, and the ICW is 5.7 miles south.

B.3.3.1.2 Geologic Structure

Vinton is a shallow lying piercement salt dome (see Figures B.3-24, B.3-25, B.3-26, and B.3-27). It is nearly circular in horizontal cross-section with steep, nearly vertical sides. The shallowest depth to salt reported is 700 feet near the southwest center of the dome.

Areas within the 1,000, 2,000, and 3,000 foot salt depth contours are approximately 155, 265, and 355 acres, respectively. Both axes of the dome at the 1,000 foot depth contour are about 2,500 feet long; the northeast-southwest major axis at the 2,000 foot level is 4,200 feet long and the minor axis is 3,360 feet. The northeast axis of the dome at the 3,000 foot depth contour is 4,800 feet long and minor axis length is 3,800 feet.

B.3-85

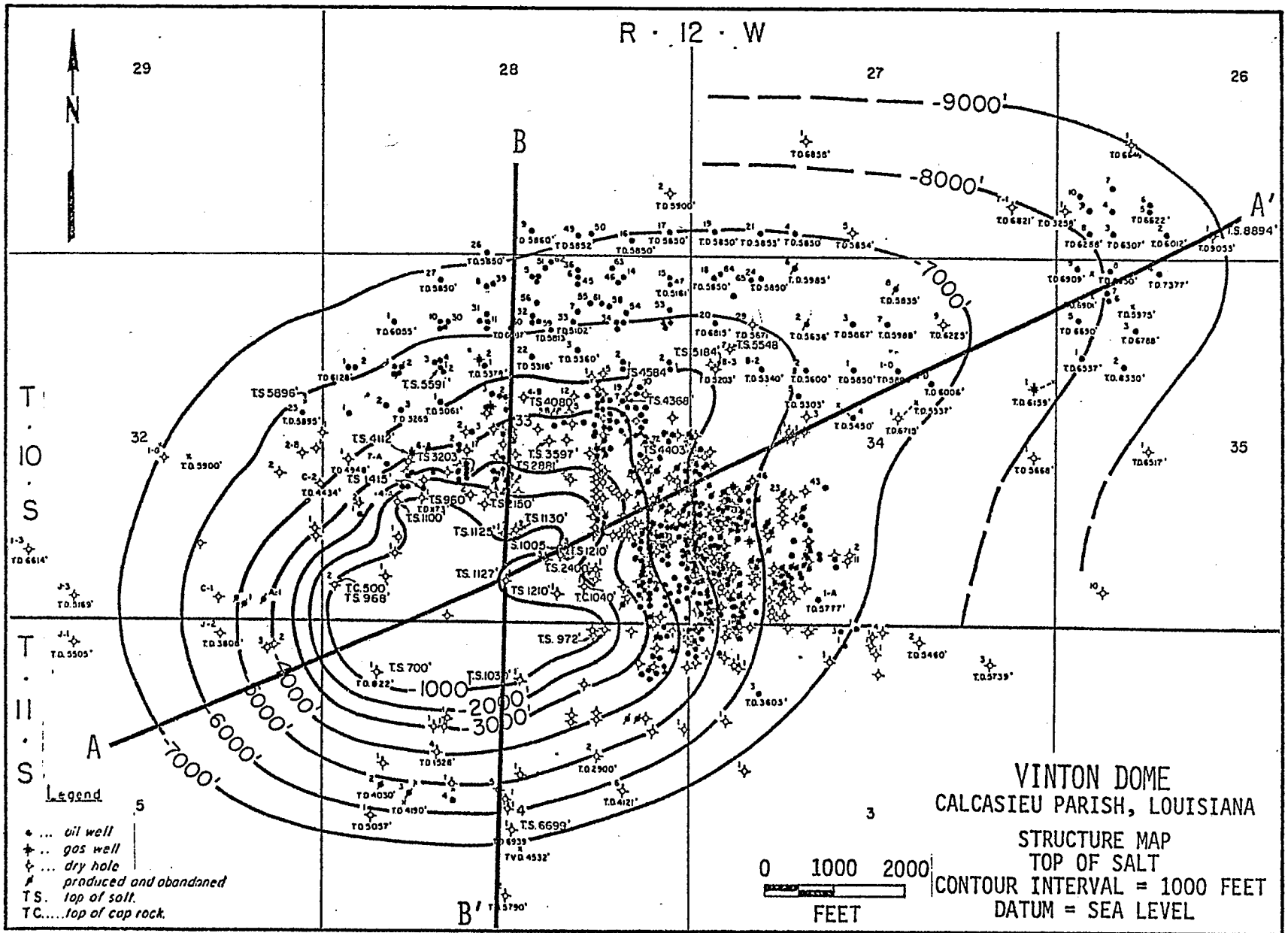

Figure B.3-24 Structure Map - Top of Salt - Vinton Dome

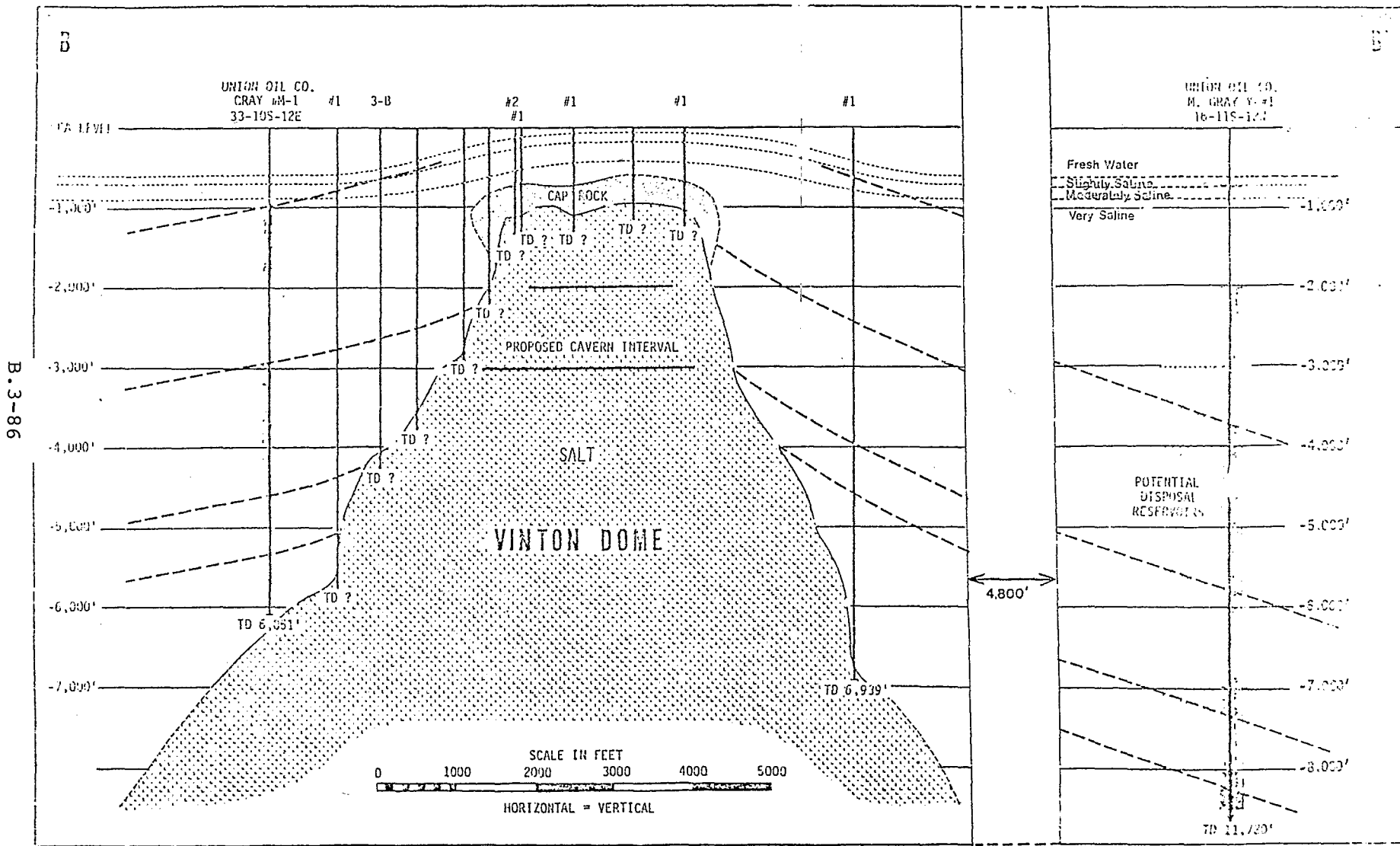

Figure B.3-25. Geologic Cross-Section of Vinton Dome B-B'

B.3-87

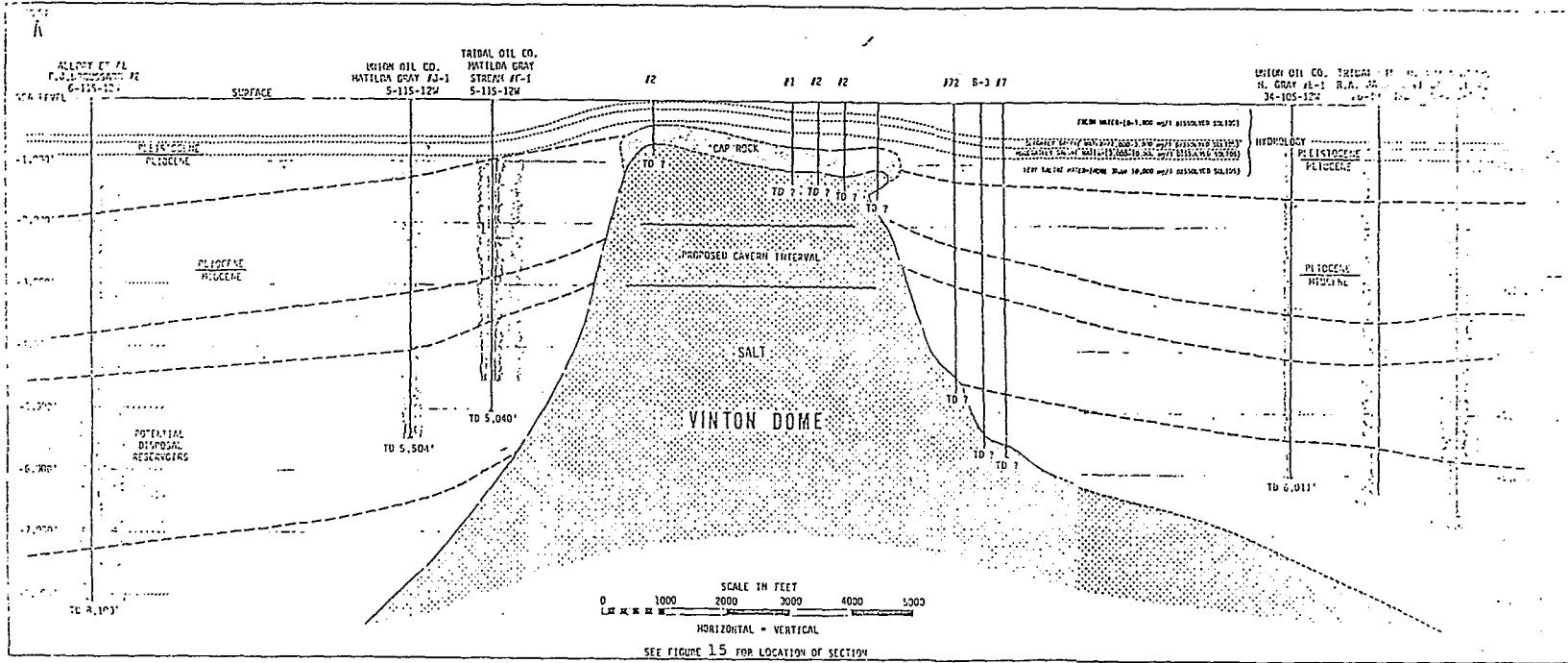

Figure B.3-26 Geologic Cross-Section of Vinton Dome A-A'

B.3-88

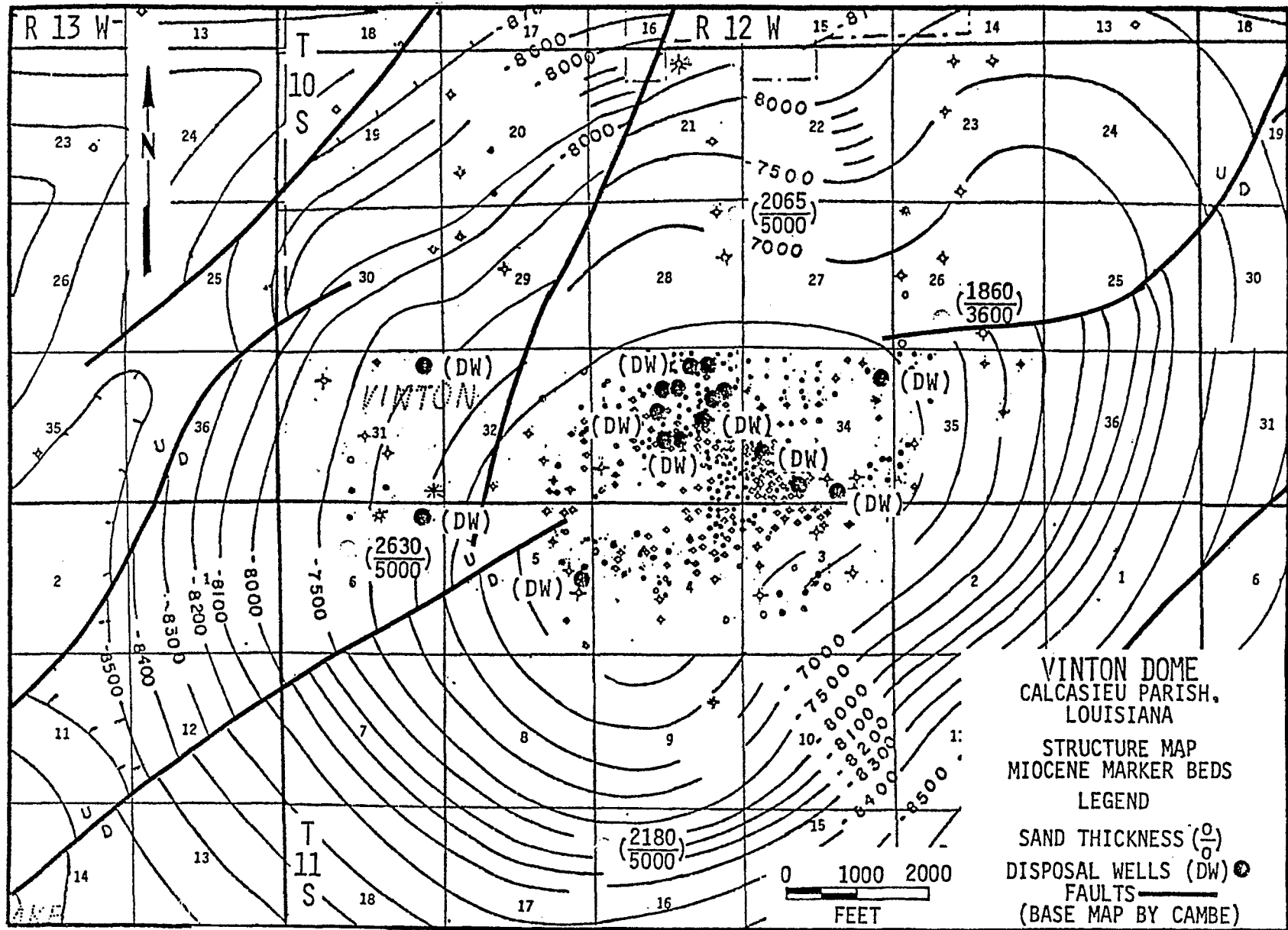

Figure B.3-27 Structure Map, Miocene Marker Beds - Vinton Dome

Little information on the faulting in the sediments surrounding the Vinton dome was found. However, the general character of faulting at Vinton can be assumed to be similar to characteristic faulting of piercement domes since Vinton is a piercement dome. Throughout the Gulf Coast area the patterns of faulting generally become more complex with depth and the faults are generally normal gravity faults (Halbouty, 1967).

Cap rock at Vinton is composed of an average (from top to bottom) of 104 feet of calcite (CaCO_3), 232 feet of gypsum ($\text{CaSO}_4 \cdot 2\text{H}_2\text{O}$), and as much as 83 feet of anhydrite (CaSO_4), for an average thickness of 419 feet. Other constituents include an average of four percent sand and shale.

The presence of sulfur in the cap rock has not been verified. However, Freeport Sulphur Company was once active in the area and was responsible for drilling at least five exploratory holes into the cap rock--and perhaps into the underlying salt stock.

Average depth to the top of the cap rock is 528 feet. Information concerning the extent of cap rock is sparse, and it has not been determined whether it extends over the flanks of the dome.

B.3.3.1.3 Stratigraphy

The detailed stratigraphic data is largely paraphrased from Thompson and Eichelberger (1928). The sands and clays in the first 200 feet below the surface at Vinton are known as the Beaumont Clay and are Pleistocene in age. The occurrence of larger grained sand and gravel probably marks the base at 400 feet below the surface (See Figure B.3-28).

The Lafayette gravel lies below the Beaumont clay and is probably late Pliocene to early Pleistocene. Though generally referred to as a gravel, the formation contains sand and small amounts of shale. Its thickness ranges from 600 to 1,000 feet.

Below the Lafayette is the Fleming clay. It is undifferentiated Miocene and Pliocene impervious clay with some sand. The thickness ranges from several hundred feet above the dome to 3,000 feet on the flank.

Underlying the Fleming clay is the Oligocene Formation which is composed of sands and sandy shales. This formation is not present on the west and southwest sides of the dome. This is not necessarily indicative of an unconformity, but possibly the result of lower Jackson shales being dragged

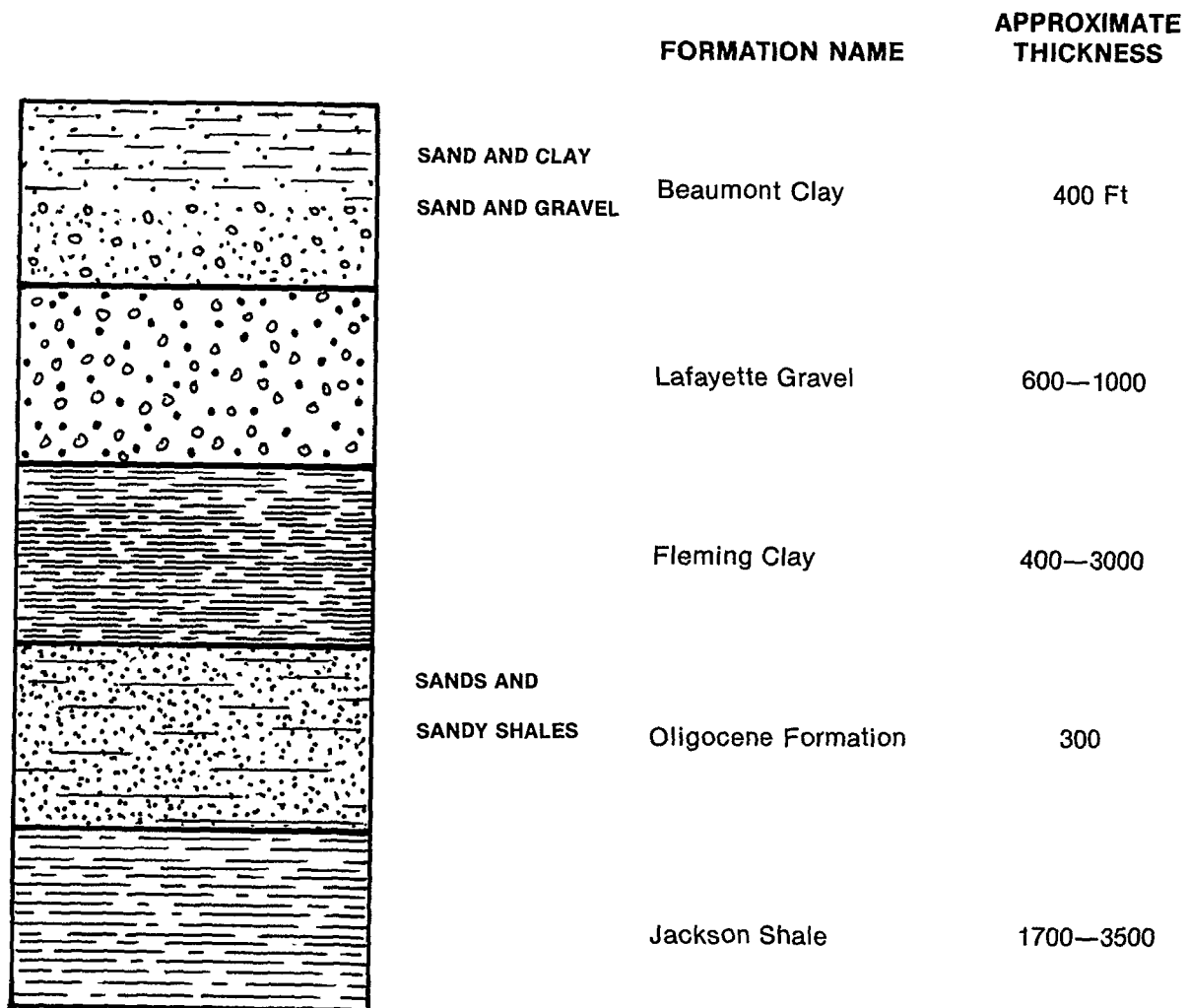

Figure B.3-28 STRATIGRAPHY IN THE VICINITY OF VINTON DOME, LOUISIANA

up by the rising salt above the level of deposition of the Oligocene sands. The thickness of this formation is estimated at 300 feet.

The Jackson shale lies below the Oligocene formation and is Eocene in age. No precise information on thickness was available but it is estimated that on the east side of the dome it extends from 1,500 to below 5,000 feet and on the west from 3,300 to 5,000 feet below the surface (Thompson and Eichelberger, 1928).

B.3.3.1.4 Soil Characteristics

The soils at the Vinton site belong to the Morey Beaumont Association, (Figure B.3-28a).

The Morey soils on the broad flats and depressed areas make up about 70 percent of the association. They have a very dark gray or black silt loam or silty clay loam surface and a gray silty clay loam subsoil mottled with yellowish-brown. The Beaumont soils on the flats and depressed areas make up about 15 percent of the association. They have a very dark gray or black silty clay loam or clay surface and a gray silty clay or clay subsoil mottled with yellowish-brown. Mowata soils make up most of the remaining 15 percent of the association, (USDA, 1971).

The oil distribution pipeline route and the brine injection site encounter Morey Beaumont and Harris Fresh Water Marsh Association.

The very poorly drained Harris soils at the higher elevations make up about 55 percent of the association. They have a black clay surface and a gray clay subsoil. About 30 percent of the association at slightly lower elevations consists mostly of peat 18 to 50 inches thick over a gray clayey material. Beaumont, Morey, and spoil banks make up most of the remaining 15 percent of the association, (USDA, 1971).

B.3.3.1.5 Mineral Resources

Since Sabine Oil and Mineral's No. 1 Johnson Vincent well became the first commercial producer at Vinton in 1910, minor production has occurred all around the dome. Greatest density of drilling has been on the north and east sides.

Figure B.3-28

SOIL DISTRIBUTION MAP OF SOUTHWESTERN CALCASIEU PARISH

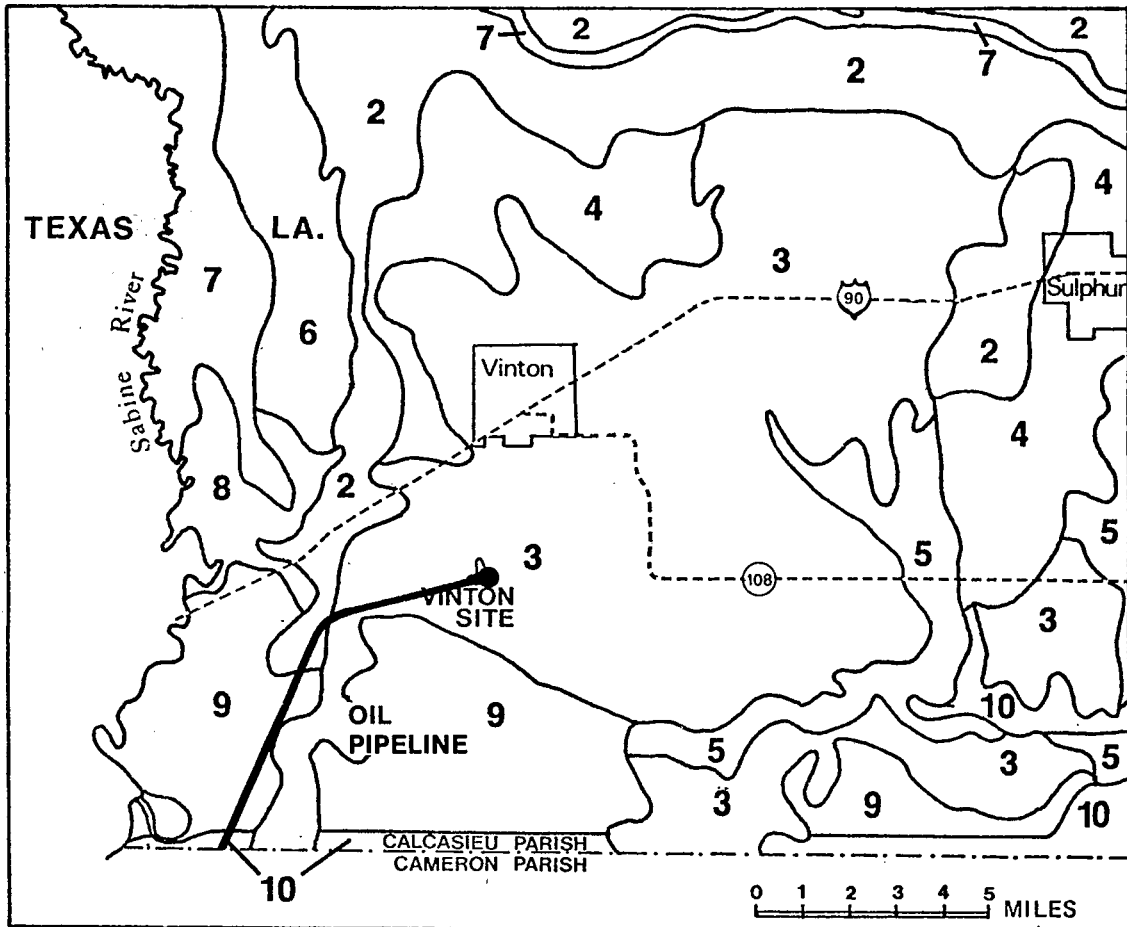

- 2** Wrightsville-Arcadia Association - level to very gently sloping silty soils with clayey subsoils.
- 3** Morey-Beaumont Association - level to depressed dark colored silt loam or silty clay loam.
- 4** Mowata-Morey-Crowley Association - nearly level to depressed silty and clayey soils.
- 5** Mowata Crowley Association - nearly level to depressed silty soils with clayey subsoils.
- 6** Leaf-Bienville Association - depressed to gently sloping silty and sandy soils.
- 7** Bibb-Mantachie Association - frequently flooded bottomland soils. Silt loam surface silty clay loam subsoil.
- 8** Swamp - swamp land, mucky clay and silty clay.
- 9** Harris Fresh Water Marsh Association - mineral and organic fresh water marsh soils. Black clay surface, gray clay subsurface.
- 10** Harris Salt Water Marsh Association - mineral and organic salt water marsh soils. Black clay surface, gray clay subsurface.

Louisiana State Department of Conservation records show that oil or gas is currently being produced from five zones whose tops range from 4,908 to 5,840 feet below the surface (see Table B.3-13). No known oil or gas production is located over the top of the dome.

Salt has not been mined at Vinton Dome, therefore, there are no caverns suitable for crude oil storage.

Table B.3-13. Hydrocarbon Producing Intervals

1. Zone "A" 5,084 feet to 5,118 feet in Union Oil's #1-C F.H. Gray Unit Sec. 33, T10S, R12W.
2. Zone "B" 4,908 feet to 4,914 feet in Union Oil's #3-G Gray, Sec. 33, T10S, R12W.
3. Zone "C" 5,295 feet to 5,320 feet in Union Oil's #12-G Gray, Sec. 33, T10S, R12W.
4. Zone "D" 5,685 feet to 5,715 feet in Union Oil's #8-G Gray, Sec. 33, T10S, R12W.
5. Zone "E" 5,790 feet to 5,840 feet in Union Oil's #11-G Gray, Sec. 33, T10S, R12W.

B.3.3.2 Water Environment

The Vinton salt dome is located in southwestern Louisiana between the Calcasieu and Sabine River basins as shown in Figure B.3-29 Ged Lake is located directly over the dome. Surface water in the area varies from fresh to brackish.

The surface water system in the region is underlain by clays which are nearly impervious to water passage. As is the case at West Hackberry and Black Bayou, the annual rainfall appears plentiful but the area generally experiences a moisture shortage for vegetation during the growing season (from February through November).

The surface water system, which is described in Section B.3.3.2.1 represents the primary source of leaching/displacement water. The subsurface water system, which is discussed in Section B.3.3.2.2 constitutes the primary site for brine disposal.

B.3.3.2.1 Surface Water Systems

Vinton dome is located approximately 5-3/4 miles north of the ICW, 1-1/4 miles west of the Vinton Canal. The surface water system depicted in Figure B.3-29 consists primarily of Ged Lake, surrounded by a network of canals, gulleys, and flumes. Most of this network nearest the dome drains to the south and east into the Vinton Canal. Several channels somewhat removed from the dome, drain to the north into the Sabine Canal. To the east of Ged Lake there are a number of small ponds or reservoirs. All available data concerning the physical dimensions of water bodies in the area are summarized in Table B.3-14.

State water quality standards for the Vinton Canal are provided in Appendix D. As indicated by these standards the bayou is to be used for secondary contact recreation and for the propagation of fish and wildlife. The canal is classified as tidal by state standards.

Water in the Vinton Canal is predominantly fresh although some salt water intrusion does occur. Several of the irrigation canals in the area have salt water barriers installed at their junctions with the Vinton Canal (Rocca, 1977).

B.3.3.2.2 Subsurface Water Systems

Vinton salt dome is located approximately 8 miles north of Black Bayou Dome. Hence, the general geohydrologic description of Black Bayou Dome applies also at Vinton. A general picture of the arrangement of the shallow aquifers can be obtained

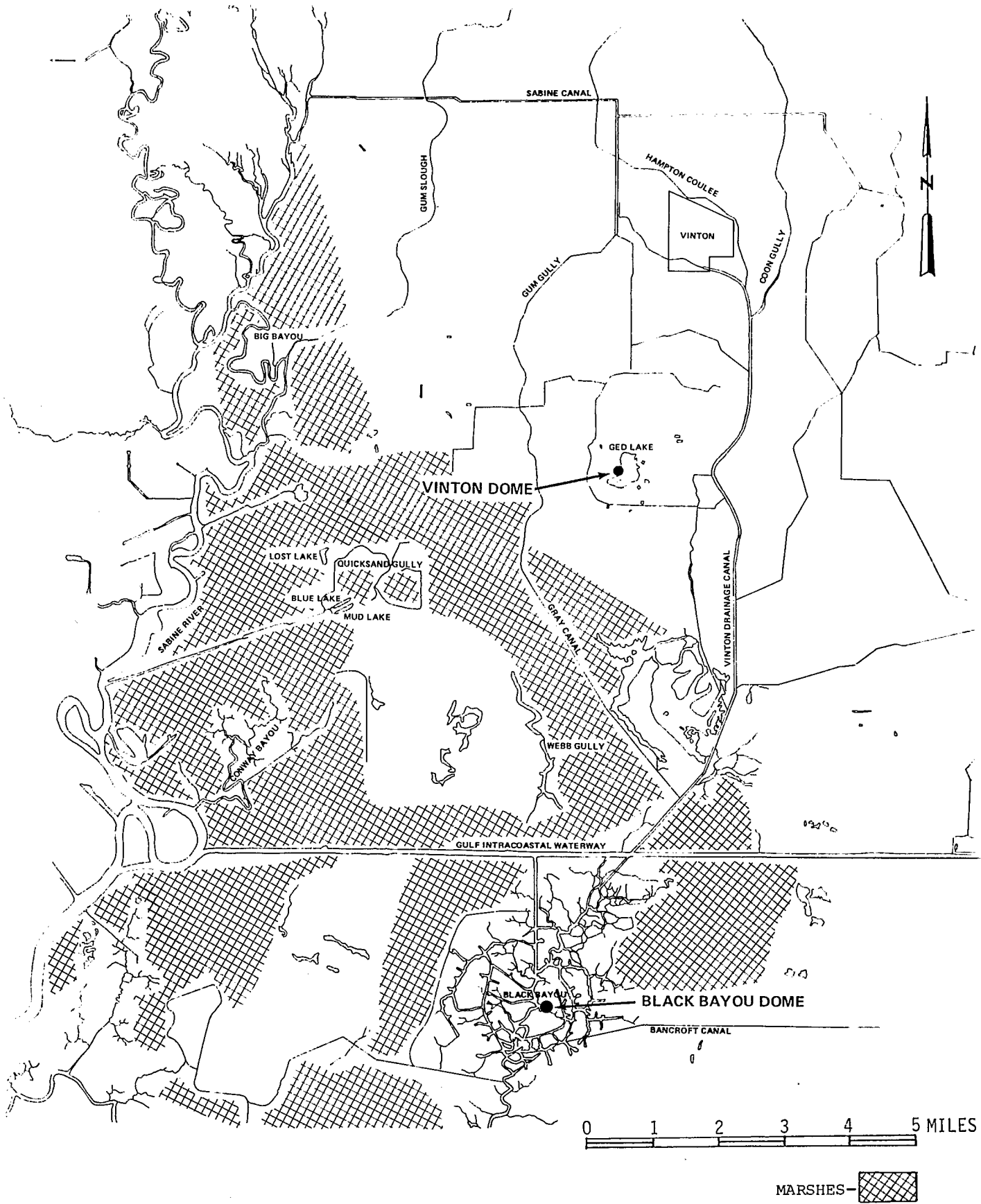

Figure B.3-29 Vinton Surface Water System

Table B.3-14. Surface Water Bodies in the Vicinity of Vinton Dome

Water Body	Distance from Dome	Direction from Dome	Direction of Flow*	Length (Miles)	Width (feet)	Depth (feet)	Area Sq. M
Ged Lake	0.1	SE	-	0.5	1320	15	0.12
Vinton Canal	1.3	E	S	10.0	60	9	0.11
Grays Canal	1.8	SW	S	2.8	40	3.0	.02
Gum Gully	1.3	NW	S	-	-	-	-
Goose Lake	4.0	S	I*	-	-	-	-
Webb Gully	4.0	SW	I	-	-	-	-
Intracoastal Waterway	7.0	S	E	22.0	300	8.0	5.95

*Indeterminate flow is indicated by the letter "I".

from the geohydrologic section presented in Figure B.3-30 Station 2 in this section is located approximately 6 miles north of the Vinton dome. Additional geohydrologic data are presented in Appendix D. Analysis of all available data indicates that at the Vinton dome the base of fresh water is between -900 and -600 feet msl. Slightly saline water occurs at a minimum depth -600 feet msl. The base of fresh ground water is generally coincident with the base of the Chicot aquifer. Because the base of the Chicot is uplifted by the Vinton dome the maximum depth of fresh water is reduced over the dome. In the vicinity of the dome the Chicot behaves as a confined aquifer, separated from the surface by nearly 200 feet of clay or shale (based on the driller's log of water well Cu-526*).

Vinton dome is slightly closer to the center of pumping at Lake Charles than Black Bayou dome. Thus, the same or slightly greater effects of local decline in water levels and movement of ground water are present.

Several water wells exist in the Vinton area. Their use, depth of completion and water quality records as of 1960 are given in Table B.3-15. The locations of the wells are indicated in Figure B.3-31.

Deep Aquifers

A thick sequence of "undifferentiated" Miocene sands, containing only saline water, begins within a few thousand feet of the surface (exact depth unknown at Vinton) and extends to approximately -7000 feet msl. These sediments consist of medium to fine-grained quartz sand, montmorillonite and illite clay and organic matter (Jones, 1969). In well logs the Miocene section appears as a repeating alternation of clays or shales and sands of varying thickness. Individual beds are continuous for a few feet to a few miles. Sand bed thicknesses vary widely and in some cases reach 400 feet of uninterrupted sand. The water salinity and temperature in these sediments increases with depth. Figures B.3-32 and 33 show temperature/depth relationships for the Manchester field in eastern Calcasieu Parish and dissolved solids content/depth relationships for a well in Hackberry field respectively (Schmidt, 1973).

*The location of water well Cu-526 is shown in Figure B.3-29.

B.3-99

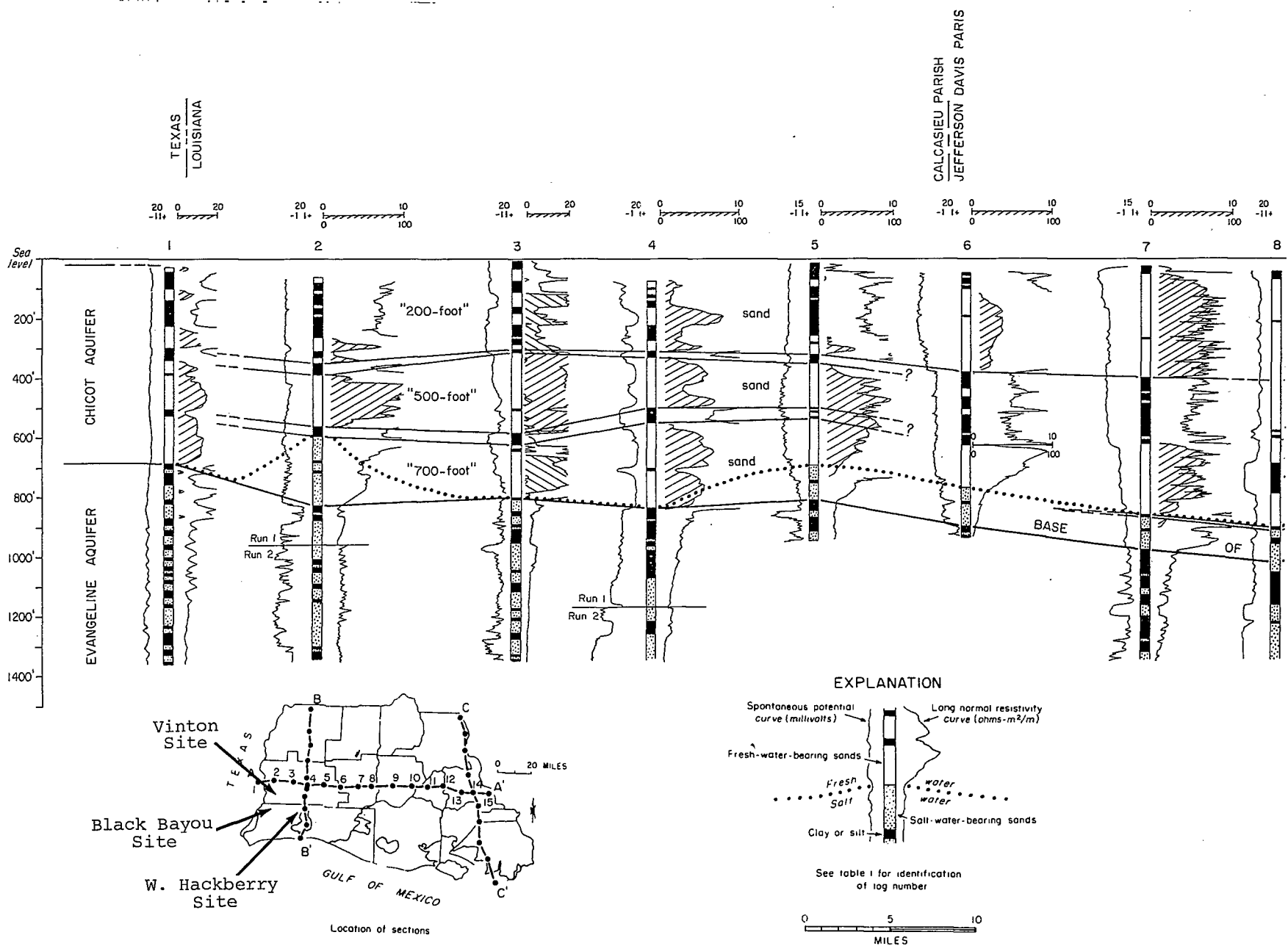

Figure B.3-30 Geohydrologic Section From Southeastern Texas to Jefferson Davis Parish, Louisiana

Table B.3-15 Water Wells at Vinton (Harder, 1960)

Well	Depth of Well (Ft)	Screened Interval	Aquifer	Use*	Chemical Constituents (p			
					Chloride	Dis. Sol.	pH	Tem
Cu-1	585	536-585	"500-ft"	P	333	398	7.4	73
Cu-2	422	-	"500-ft"	A				
Cu-108	668	648-668	"700-ft"	I	160			
Cu-225	338	308-338	"500-ft"	I	14			
Cu-226	500	-	"500-ft"	A	90			
Cu-256	516	-	"500-ft"	D				
Cu-488	600	-	"700-ft"	I				
Cu-536	652	620-652	"500-ft"	I				
Cu-529	276	261-276	"500-ft"	D				
Cu-533	595	515-595	"500-ft"	Ir				
Cu-531	514	422-514	"500-ft"	Ir	116			79
Cu-544	535	513-534	"500-ft"	I				
Cu-555	602	517-597	"500-ft"	P				

*Use: A, abandoned; D, domestic; I, industrial; Ir, irrigation; P, public.
 (all data in this table from Harder, 1960)

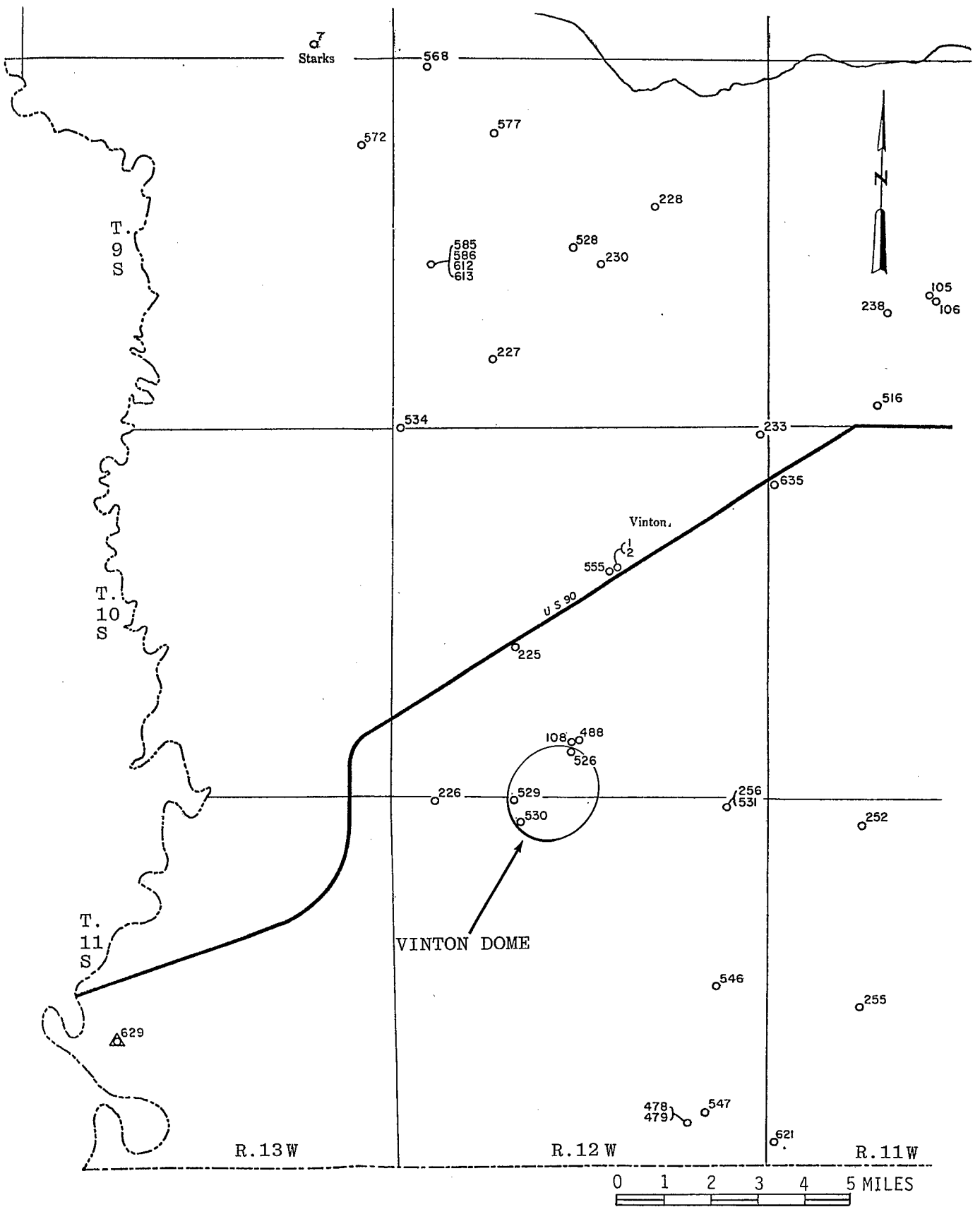

Figure B.3-31 Vinton - Water Well Locations
B.3-101

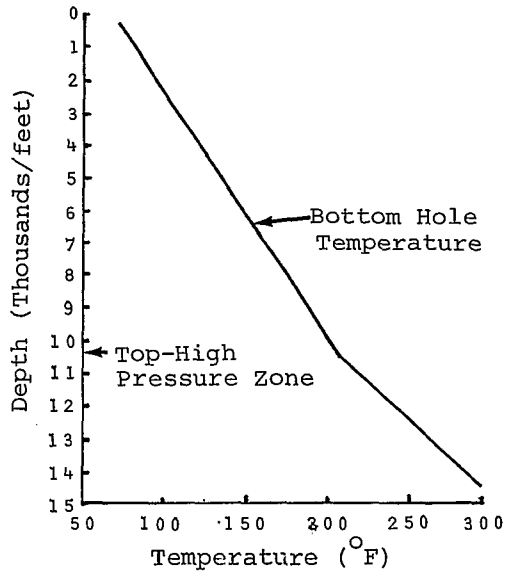

Figure B.3-32 Measured temperature versus Depth in Eastern Calcasieu Parish

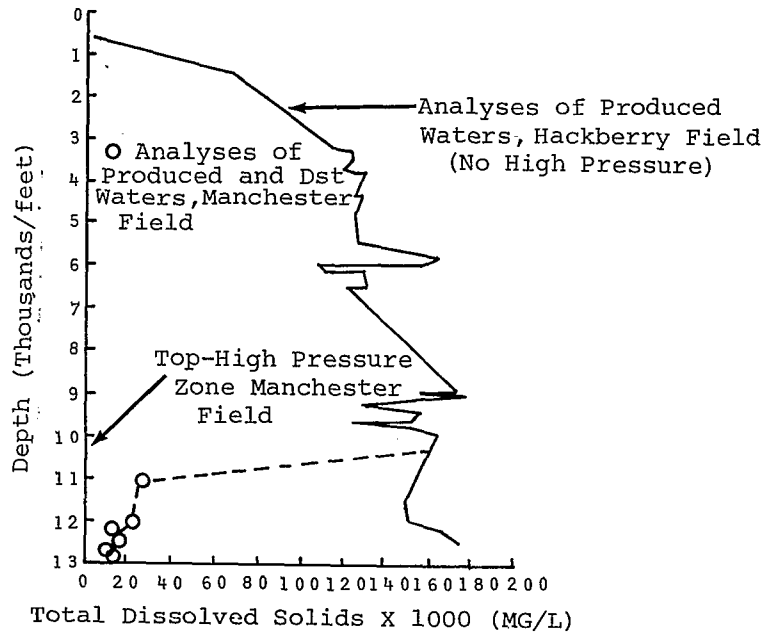

Figure B.3-33 Changes in total dissolved solids concentrations of produced waters from sandstones with depth, from wells where high pressure is present and not present.

Brine disposal by injection into the Miocene sands is proposed in an area south of Vinton dome. Fourteen wells exist within an area extending 10 miles east and west and tangent to the southern flank of the dome and extending south from the dome 5 miles. The wildcat wells in this area are widely spaced, making correlations of individual sands impossible. The lateral continuity of sands in this area may be limited by faulting associated with the domal structure and by the erratic nature of the deltaic deposits of the Miocene section. Figure B.3-34 a generalized map of the major faults in the area (Wallace, Fault and Salt Map of South Louisiana).

Three representative well logs were studied to determine the relative amount of Miocene sand present in the Vinton dome area. The volume of sand and shale was determined for each log beginning at approximately -1500 feet msl and continuing to the base of the sand sequence, usually at about -7000 feet. Below this depth a thick shale unit, the Hackberry wedge, is present. The three wells and their respective sand and shale percentages are shown in Table B.3-16. A minimum of 11 sands, 50 feet thick; 7 sands, 100 feet thick; and 3 sands, 150 thick were present at each well.

B.3.3.3 Air Quality

B.3.3.3.1 Existing Air Quality

Since onsite monitoring has not been conducted at the proposed Vinton expansion site, the regional air quality levels established in Section B.2.3.3 are used to predict the existing air quality at the Vinton Site. Based on these data, the ambient concentrations of NMHC and photochemical oxidant are predicted to be high and might exceed the existing standards. All other pollutants are expected to be in compliance with the applicable standards.

B.3.3.3.2 Projected Air Quality

Projection of SPR activities at Vinton indicate that the nitrogen oxides, carbon monoxide, and particulate concentration are expected to be in compliance with standards in the following 10 years. However, sulfur oxides and NMHC are expected to exceed the ambient air quality standard due to the increased marine terminal operation. The high NMHC concentration would result in the projections of oxidant level exceeding standards.

B.3.3.4 Background Ambient Sound Levels

Background noise levels in and around the alternative SPR site at Vinton salt dome expansion are typical of a rural area in the SPR region. See Section B.2.4.

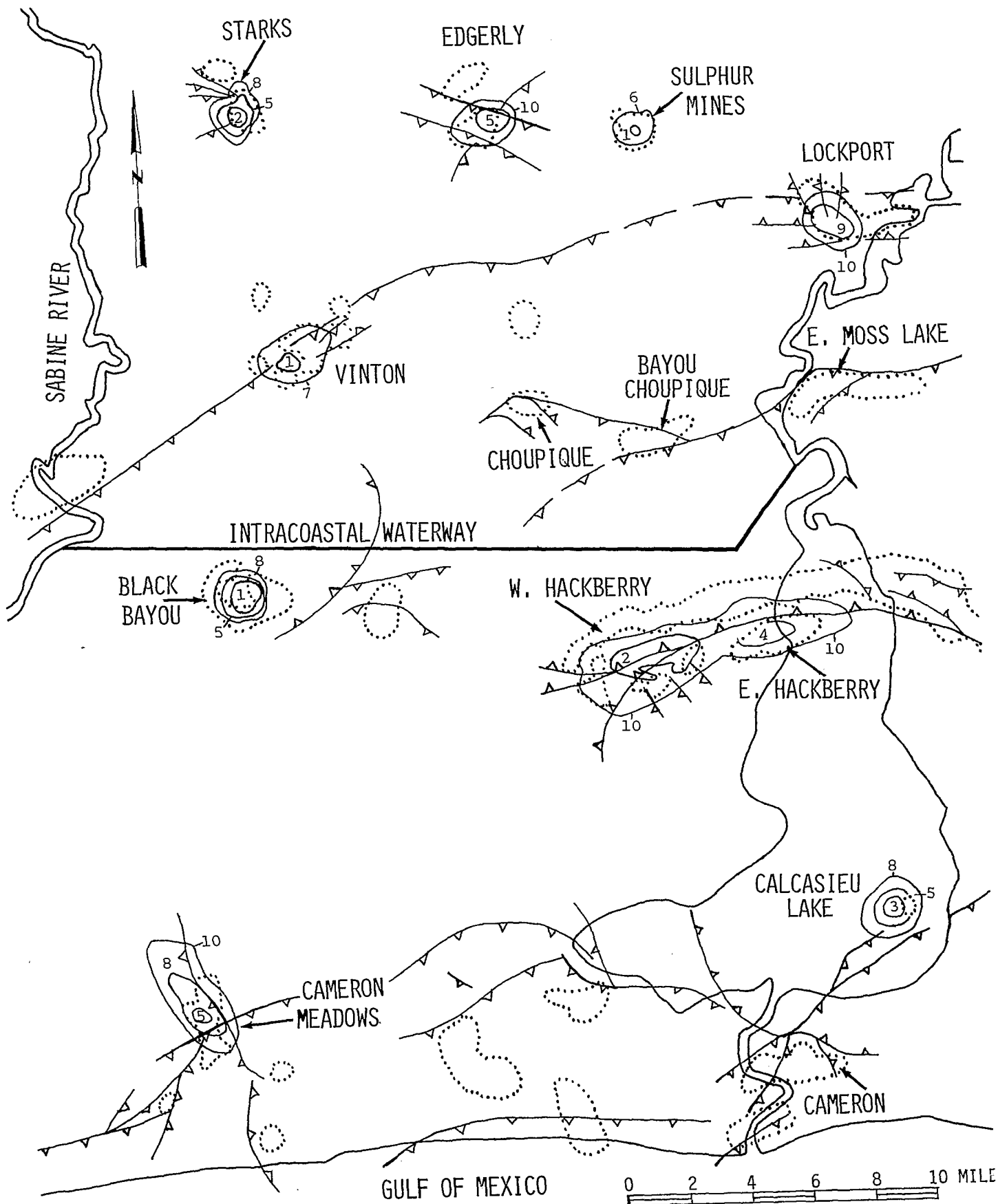

Figure B.3-34 Salt Fault Map (Wallace, 1966)
B.3-104

Table B.3-16. Results of Well Log Analysis Near Vinton Dome

		Top of Log (feet)	Base of Miocene Sand (feet)	<u>Percent</u> sand shale	
Cyprus Oil Co. B. M. Odom #1	Sec. 22-T11S; R13W	1814	7850	52	48
Union Oil Calif. Matilda Gray et al. "S", #2	9-T11S; R12W	1392	7100	47	53
Roy R. Gardner Mecom #1	Sec. 10-T11S; R13W	1834	7190	53	47

A minimum of 11 sands 50 feet thick, 7 sands 100 feet thick, and 3 sands 150 feet thick were present in each well

B.3.3.5 Species and Ecosystems - Vinton

B.3.3.5.1 Environmental Setting of the Displacement/Leaching Water System

Displacement/Leaching water would be drawn from the Vinton drainage canal about 5000 feet east of the dome. Initially the pipeline would proceed from the central plant area south across the dome for .5 miles, covering land which is at the present time being used as cattle and horse pastureland. It would then turn east for about .75 miles and northeast for 1.0 mile until it intersects with the canal. Shortly after the pipeline turns east, it would cross disturbed land with second-growth grasses and shrubs. After .5 mile small groups of trees are encountered. This open forest continues for .65 miles until disturbed second-growth grasslands again appear. The proposed route then continues through this disturbed area for .35 miles until it intersects with the Vinton drainage canal. For the last mile of the route the pipeline would parallel a light-duty road.

B.3.3.5.2 Environmental Setting of the Brine Disposal System

The current design specifies brine disposal into subsurface saline aquifers. The brine pipeline to the disposal wells would follow the displacement/leaching water system corridor south for .5 miles and then east for .75 miles. Most of this land has been referred to previously as pastureland and disturbed grassland. The route then turns south for 1.5 miles across disturbed grassland and scattered trees. The pipeline at this point joins the wellhead area which consists of 10 wells in a linear array with 1000 foot intervals. The well head area lies within a complex of fresh water marsh and grassland with 6 of the 10 wells lying within the marsh. (Figure A.6.4).

B.3.3.5.3 Environmental Setting of the Site

The plant area would require approximately 60 acres of land for the placement of ponds, tanks, buildings, wellheads, and access roads, with an adjacent equipment yard of roughly the same size. It is anticipated that the plant and equipment yard would be placed in pastureland west of Ged Lake and east of buildings which are already on the dome. The existing buildings consist of a large summer house, horse stables, barn and 4-6 smaller houses. Trees on the dome are found only in the immediate vicinity of the buildings and it is anticipated that no clearing of land would be necessary for the site installation. From the buildings, the pastureland is relatively flat with a gentle slope in the direction of the lake.

Placement of storage cavern wellheads would also involve no clearing of vegetation as all wellhead locations, with the possible exception of two, are in pastureland. One of these two wellheads is the western most of the group, while the other is located 800 ft. northeast of the first. These two may require the clearing of nearby trees.

B.3.3.5.4 Environmental Setting of the Oil Distribution System

Crude oil would be transported in a 31-mile pipeline system between Vinton and Sun Terminal in Nederland, Texas. The proposed new 7.5 mile link to the existing ESR distribution system would proceed west from the site for 1 mile, initially crossing pastureland and later passing through disturbed second-growth grassland. The route would then join an existing pipeline right-of-way (TCGPL) which it would follow to the Intracoastal Waterway. When the pipeline joins the TCGPL corridor it would travel in a southwest direction for 2.25 miles through disturbed second-growth grassland and freshwater marsh. The route would then turn south covering 2 miles of prairie and .25 miles of marsh, followed by a 1 mile portion composed of half grassland and half marsh. From this point the route is south to the ICW through .75 miles of grassland and .5 miles of marsh. The marshland between the Vinton dome and the ICW becomes increasingly saline the further south marsh is encountered. Immediately south of the dome the marsh is essentially of a freshwater type while near the ICW, a more intermediate saline marsh is found. The pipeline would then cross the ICW to join with the ESR distribution pipeline between West Hackberry and Sun Terminal. The portion of this route from the point at which the pipeline joins the ESR distribution system to the Sun Terminal has already been described in Section B.3.1.5.4 (Environmental Setting of the Oil Distribution System for West Hackberry.

B.3.3.6 Natural and Scenic Resources

The surface land around Vinton dome is at the present time being utilized as a cattle and horse ranch. Although it is on private land and closed to the public, it is a very scenic ranch with several large houses, stables, and barns. Adjacent to the houses is Ged Lake, a freshwater impoundment on the high ground of the dome. It is one of the few freshwater lakes in the area which does not have a marsh surrounding part of the lake.

B.3.3.7 Archaeological, Historical and Cultural Resources

The only recorded archaeological site in the vicinity of the Vinton dome and its associated pipeline routes is a shell midden which is within 200 feet of the ESR oil pipeline adjacent to the Sabine River in Louisiana.

As mentioned in Section B.2.7, the pond on the Avery Island salt dome yielded valuable artifacts when an archaeological investigation of the pond sediment was made. A recently completed cultural resources survey of Vinton dome indicates that presence of several sites in the Ged Lake area (Thomas, et al., 1977). The extent and significance of these sites has yet to be determined, pending a decision on development of the site.

No sites listed in the "National Register of Historic Places" (National Park Service, 1977), were found to be in the vicinity of the Vinton dome or proposed oil and brine pipelines. A recently completed cultural resources survey of Vinton dome indicates the presence of several shell midden sites in the Ged Lake area (Thomas, et al., 1977). The extent and significance of these areas has yet to be determined, pending a decision on development of the site.

B.3.3.8 Socioeconomic Characteristics

B.3.3.8.1 History and Cultural Patterns

The area around the Vinton dome site was in the disputed border territory between Spanish and French land claims in the New World. This was an area infested with outlaws, pirates, and smugglers. The first trading post in West Calcasieu was established at Niblett's Bluff, near the present town of Vinton. One of the two main trade routes from the Mississippi River to Texas was along a trail that lay approximately where Highway 90 and Interstate 10 cross the fields through this area. Vinton was established along that route in about 1880, and has strong ties to the Western influences of Texas as well as to the Acadian French culture of south central Louisiana.

B.3.8.2 Population

The Vinton salt dome is in Calcasieu Parish about a mile and a half south of the town of Vinton. The population of Vinton was recorded as 3,454 in 1970, a 15.6 percent increase over the previous count of 2,987 in 1960. Residential growth has spread westward from Vinton toward the small village of Toomey and toward Niblett Bluff (see Figure B.3-35). Vinton is best known as the home of Delta Downs, a horse race track which attracts spectators from Texas as well as from the Southwest Louisiana region. The track has a capacity for seating 1,200 people.

Population Projections

Calcasieu Parish experienced a growth rate of 62 percent between 1950 and 1960, when the population expanded from 89,635 to 145,475. In the following decade, the Parish had a marginal decline in population to a total of 145,415 which represents a loss of less than one percent. Most of the fluctuation in growth occurred in the urban areas of the parish. The Vinton Dome is in Ward 7, a predominately rural area where the population increased by 10 percent between 1950 and 1960 when it grew from 4,166 to 4,581, and by 19 percent between 1960 and 1970 when it reached a total of 5,471. The salt dome and brine disposal field would be about 3 miles south of Interstate Highway 10, and most of the growth in Ward 7 has occurred north of the Highway.

Population projections for the Vinton urban area, estimated by the Imperial Calcasieu Regional Planning Commission, are as follows:

	<u>1970</u>	<u>1980</u>	<u>1990</u>
Vinton	3,454	4,300	5,100

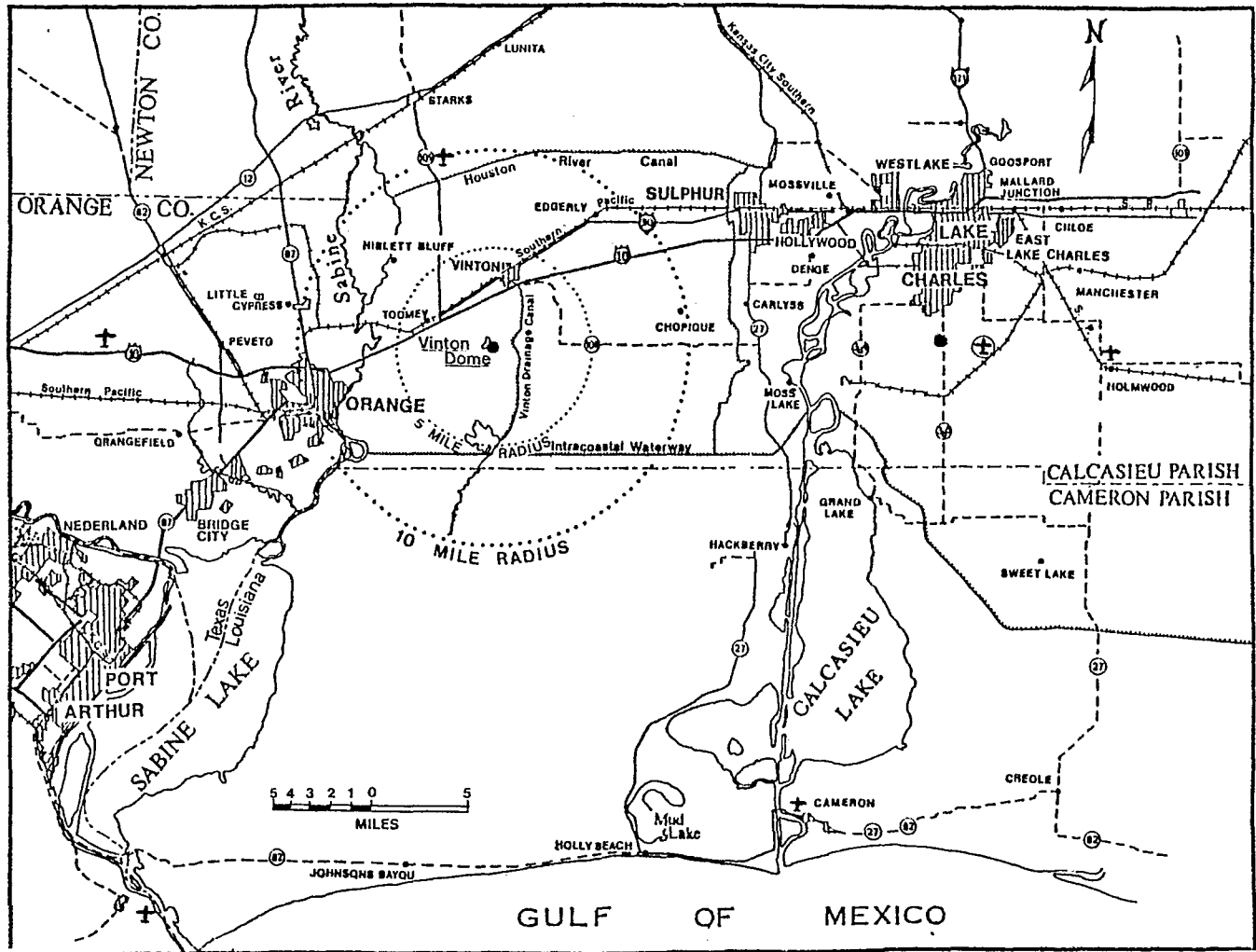

Figure B.3-35 Towns and Cities Around the Vinton Site

This indicates a growth rate of 24 percent in the current decade, and 19 percent in the next one. The projected growth rates of the Vinton urban area are only slightly above those forecast for all urban areas in Calcasieu Parish. The total population of all urban areas is expected to increase by 21 percent between 1970 and 1980, and by 18 percent between 1980 and 1990. The population of the Vinton urban area constitutes only 3 percent of the urban population in the parish, and although its growth rate is slightly higher, its proportionate share of urban population will remain at about 3 percent through 1990.

B.3.3.8.3 Land Use Patterns

Calcasieu Parish is one of the five parishes that comprise the Imperial Calcasieu Planning Region. The current distribution of land in the parish is as follows:

agricultural lands	336,904 acres	49.16%
forests	183,349 acres	26.75%
undevelopable wetlands	92,946 acres	13.56%
residential, commercial, and industrial areas	51,187 acres	7.47%
public/semi-public and recreational lands*	15,245 acres	2.23%
water bodies	5,696 acres	0.83%
TOTAL	685,327 acres	100.00%

Land use plans for Vinton allow for its urban acreage to increase by 596.12 acres or 67 percent by 1990. The majority of the acreage is anticipated to be used for residential development which will occur westward of the present town, along Interstate Highway 90. Some industrial growth is expected to occur south of Vinton, on State Highway 108. Efforts are being made by regional planners to discourage commercial strip development along major highways and to encourage buffer zones of open space or parks between industrial and residential zones (Imperial Calcasieu Regional Planning and Development Commission, 1974).

*Includes the Lake Charles Municipal Airport, Chennault Air Force Base, Sam Houston State Park, and the Sabine Island Wildlife Management Area.

The proposed storage site is at Ged Lake. There are a few homes on the shore of the lake, and the surrounding pasture lands are grazed by horses and cattle. Several producing oil wells are located on the periphery of the salt dome. The brine disposal field would be located farther south, on the edges of the marshes. The pipeline right-of-way leading to the brine disposal field would cross these pastures, and the one leading to the proposed oil pipeline along the Intracoastal Waterway would cross the pastures, marshes, and the Waterway itself.

B.3.3.8.4 Transportation

The Vinton salt dome lies under Ged Lake and an agricultural section of Calcasieu Parish. South of the dome are uninhabited marshes. Workers traveling to the Vinton salt dome would arrive at the town of Vinton via Interstate 10 from Sulphur and Lake Charles, which are 13 and 22 miles east, respectively, and from Orange which is 11 miles west. The number of vehicles using Interstate 10 in the vicinity of Vinton ranges from an average of 9,070 just east of the town to 11,000 at the bridge over the Sabine River, west of Vinton (Louisiana Department of Highways, 1971). Workers would then travel over a gravel road (which is not state maintained) to the storage site. Use of this gravel road amounts to an average of about 60 vehicles per day. The road ends at the southwest end of Ged Lake and is used primarily for access to the residential homes and oil wells around the lake.

The dome lies within 6 miles north of the Intracoastal Waterway. Approximately 5,200 self-propelled vessels travel each direction yearly on this waterway (Corps of Engineers 1975). The Vinton Drainage Canal is a navigable waterway lying 1.5 miles east of the salt dome. Vessels in the Intracoastal Waterway can reach the Vinton port facilities via this Canal. In 1975, the Corps of Engineers registered a total of 6 self-propelled vessels using the canal during the year. The canal can accommodate vessels having a draft of up to 9 feet.

Airports nearest the site are located at Lake Charles and Port Arthur. The Southern Pacific Railway passes through Vinton, 1.5 miles north of the site.

There are several oil and gas pipelines crossing through the area around the dome. Cities Service has a 6 inch oil pipeline that branches out to other oil fields north and southeast of the Vinton dome, and a 20 inch pipeline that runs east and west very near the dome. Bayou Pipeline also has an oil line crossing east and west in the vicinity of the dome. Gas pipelines through this area include a 6 inch Continental line running northeast to southwest, and the Transcontinental Gas Pipe Line's 20 inch and 12 inch lines running north and south about a mile west of the site.

B.3.3.8.5 Housing and Public Services

During the 1970 Census, Vinton was found to have a total of 1,073 housing units. Of these, 2 were for sale and 17 were for rent. Although Vinton is a fast-growing community, a greater supply of available housing to accommodate project workers is located in the major cities nearby. The closest of these cities is Orange, Texas which is described in detail in the regional environment description.

Health facilities at Vinton are limited to a few private doctors' offices. However, there are fire protection services that provide assistance in emergency situations.

B.3.3.8.6 Economy

The economy of Western Calcasieu parish is dependent on agriculture and the production of oil and gas. The primary crop is rice, the value of which has risen sharply since 1971. Income from the rice harvest in the whole state had been generally at a level of about 100 million dollars during the late 1960's, and nearly tripled in the early 1970's (Louisiana Almanac 1975-76). Calcasieu Parish is a prime rice growing part of the state.

Cattle production is also a major source of income for the area. Stretches of marshland along the coastal prairie are often used to augment pastures as a grazing area for the cattle.

Onshore production of oil and gas in the south western coastal region of Louisiana is declining. Crude oil production in Calcasieu Parish in 1972 was about 7.1 million barrels, compared to 12.8 million barrels in Cameron Parish for the same year. During the same year, Calcasieu Parish production of natural gas was 54.6 million cubic feet, compared to 393.4 million cubic feet in Cameron Parish. The land surrounding the Vinton salt dome is part of the Vinton oil and gas field, one of over 25 oil and gas fields in the parish west of the Calcasieu River.

A small port facility at Vinton ships out local products and commodities to the larger cities in the region via the Intracoastal Waterway. In 1975 about 8,000 tons of crude petroleum were shipped, in addition to nearly 6,000 tons of unmanufactured marine shells.

B.3.3.8.7 Government

Vinton was incorporated in 1910 and is governed by a mayor and board of aldermen. These five aldermen are elected by the population at large, and each serves a term of four years. Vinton has for many years owned its local utility system which has served as a source of revenue to cover the expense of running the town. The port facilities on the Vinton Drainage Canal lie outside the present boundaries of the town, and are designated for tax purposes as the Vinton Harbor and terminal district.

Vinton and the Vinton Salt Dome are in Calcasieu Parish. The total assessed value of taxable property in Calcasieu Parish in 1973 was \$307,172,760. The value of real estate contributed 32 percent, personal property: 51 percent, and public service corporations: 17 percent. The proportionate value of personal property in the parish is high compared to the State average of 31 percent in that category. Taxes levied for schools are higher than those for roads, drainage, and general administration, and contribute more for education than most other parishes.

Calcasieu Parish is unlike other parishes in the State by virtue of its authority to pass zoning restrictions affecting lands outside of municipal boundaries. It is currently in the process of classifying lands in order to implement this prerogative. The Parish Police Jury has authority to issue permits for the construction of buildings and the crossing of roads and waterways.

B.3.4 Alternative Site - Big Hill

B.3.4.1 Land Features

B.3.4.1.1 Geomorphology

The Big Hill Salt Dome is located in southwestern Jefferson County Texas, 22 miles southwest of Port Arthur, 70 miles east of Houston and 9 miles north of the Gulf of Mexico.

The roughly circular surface mound overlying the Big Hill Dome is superimposed on a low ridge which Henley (1925) describes as an old shoreline. The mound is 35 feet above sea level on the north side and 31 feet on the south with a shallow saddle between these two points. The surrounding coastal plain dips toward the Gulf at approximately 5 feet per mile and in places 1 to 3 feet per mile (Fisher, 1973). The average elevation of the plain around the mound is 10 feet. Less than a mile south of the dome is the northern boundary of the intermediate marsh which eventually grades into brackish and saline marsh at the coast.

The surface of the plain is of fluvial and deltaic origin. Meandering streams deposited sediments in flood plain and formed deltas throughout the area during Pleistocene time.

B.3.4.1.2 Geologic Structure

Big Hill Salt Dome is a piercement dome with a nearly circular horizontal cross section, irregular top and steep sides with an overhang on the southeast side.

As with most piercement salt domes the sediments flanking Big Hill dome have been dragged upward by the rising salt. The fault patterns that developed during salt movement is characteristic of piercement domes.

Figure B.3-36, a structure map constructed on a Miocene marker bed (Frio Marker), shows a major northwesterly trending fault system which possibly controlled salt emplacement. In addition, a series of radial faults have been interpreted along the perimeter of the dome.

B.3-116

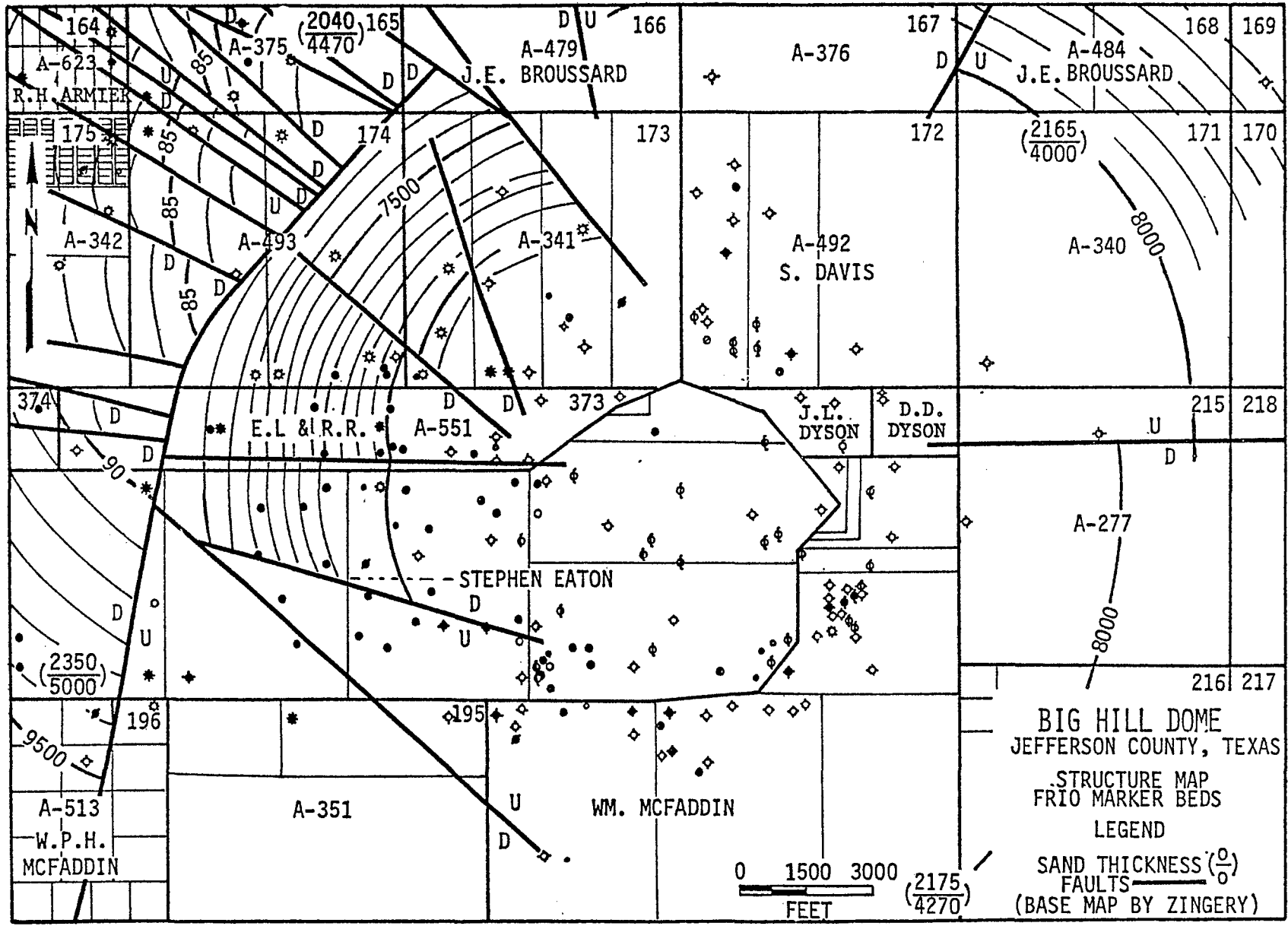

Figure B.3-36 Structure Map, Frio Marker Beds - Big Hill Dome

A characteristic fault pattern has been found to exist in the cap rock and around the flanks of domes where extensive drilling programs have been conducted. This pattern reflects normal, radial faulting with subsidiary, arcuate, concentric, normal faults between the radial faults. The greatest displacement of the faults adjacent to and away from the dome is greater at depth, and becomes progressively smaller upward. This type of faulting is seen on the western flank of the dome. Such faults are believed to die out before reaching shallower, less saline aquifers.

A geological cross section (Figure B.3-37) was constructed using available electric logs to show some of the local sedimentary sequences and their relationship to the piercement salt mass. Figure B.3-38 is the structure map for the top of the salt.

The cap rock is composed of a very porous limey sandstone on the outer edge of the cap and a porous dolomitic limestone (not primary limestone), gypsum, and anhydrite at the bottom (Henley, 1928).

Over the central part of the dome there are apparently few drill holes which penetrate fully through the cap rock and into the salt. It appears, however, that some 1,200 to 1,300 feet of cap rock are present over the dome.

Top of the cap rock appears to reach its shallowest depth of 195 feet near the center of the dome. It is believed that the depth to salt in the same area is near 1,600 feet, making maximum cap rock thickness about 1,400 feet.

Cap rock apparently covers the entire salt mass, because several drill holes around the periphery of the dome reportedly encountered cap rock but were not deep enough to intersect salt. The geologic cross section in Figure B.3-37 shows the lateral extent of the cap rock, and Figure B.3-39 is an interpretation of cap rock structure from available subsurface data. Because the entire cap rock interval was not penetrated, cap rock thickness in most of these wells is inferred.

Cap rock is usually intensely fractured and faulted due to upward pressures exerted by the rising salt stock. The faulting, fracturing and leaching action of percolating ground waters occurring in the cap rock often result in the formation of vuggy to cavernous porosity and associated high permeabilities. As a result, severe drilling fluid loss is often experienced while drilling the cap rock interval. The

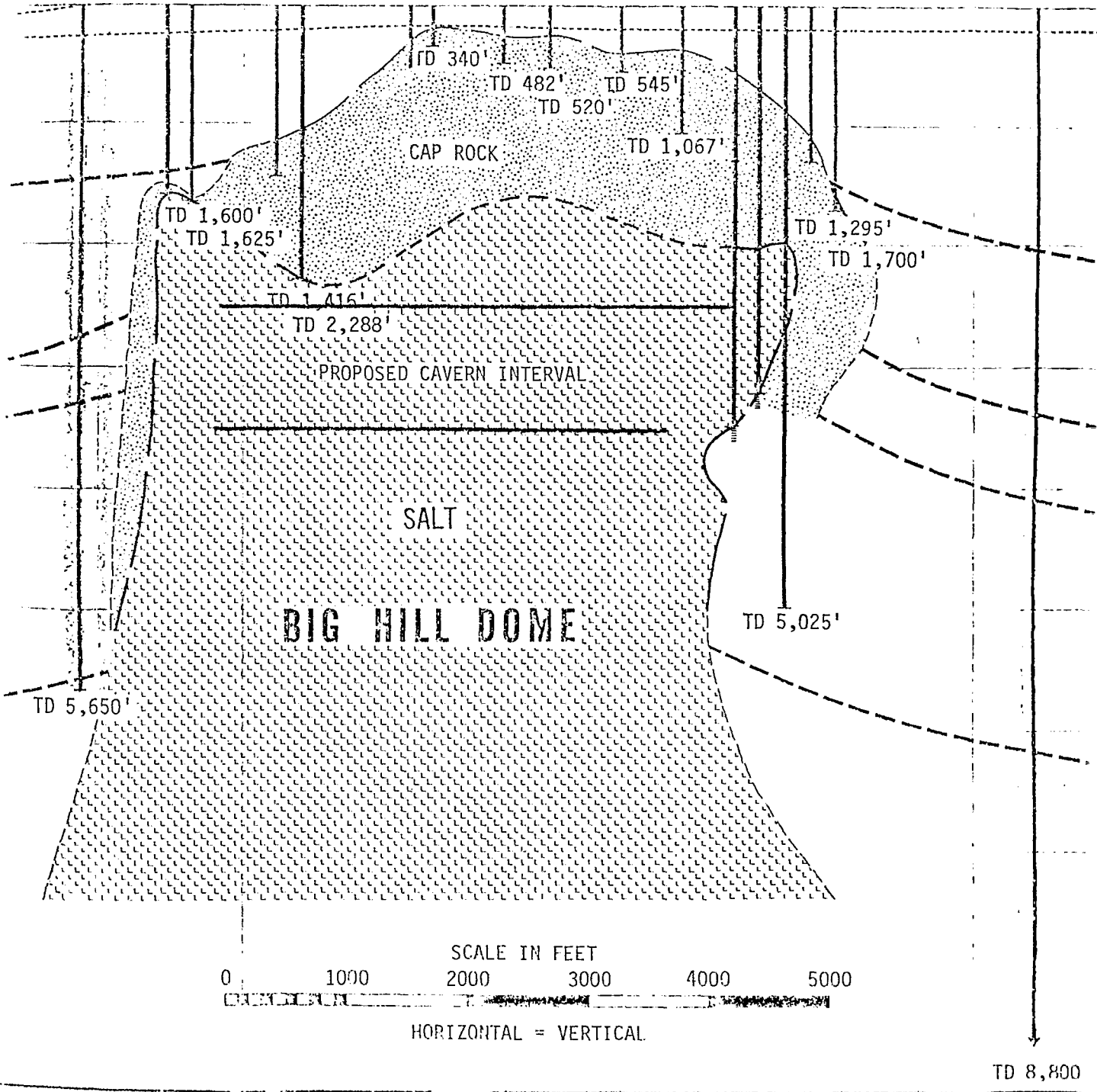
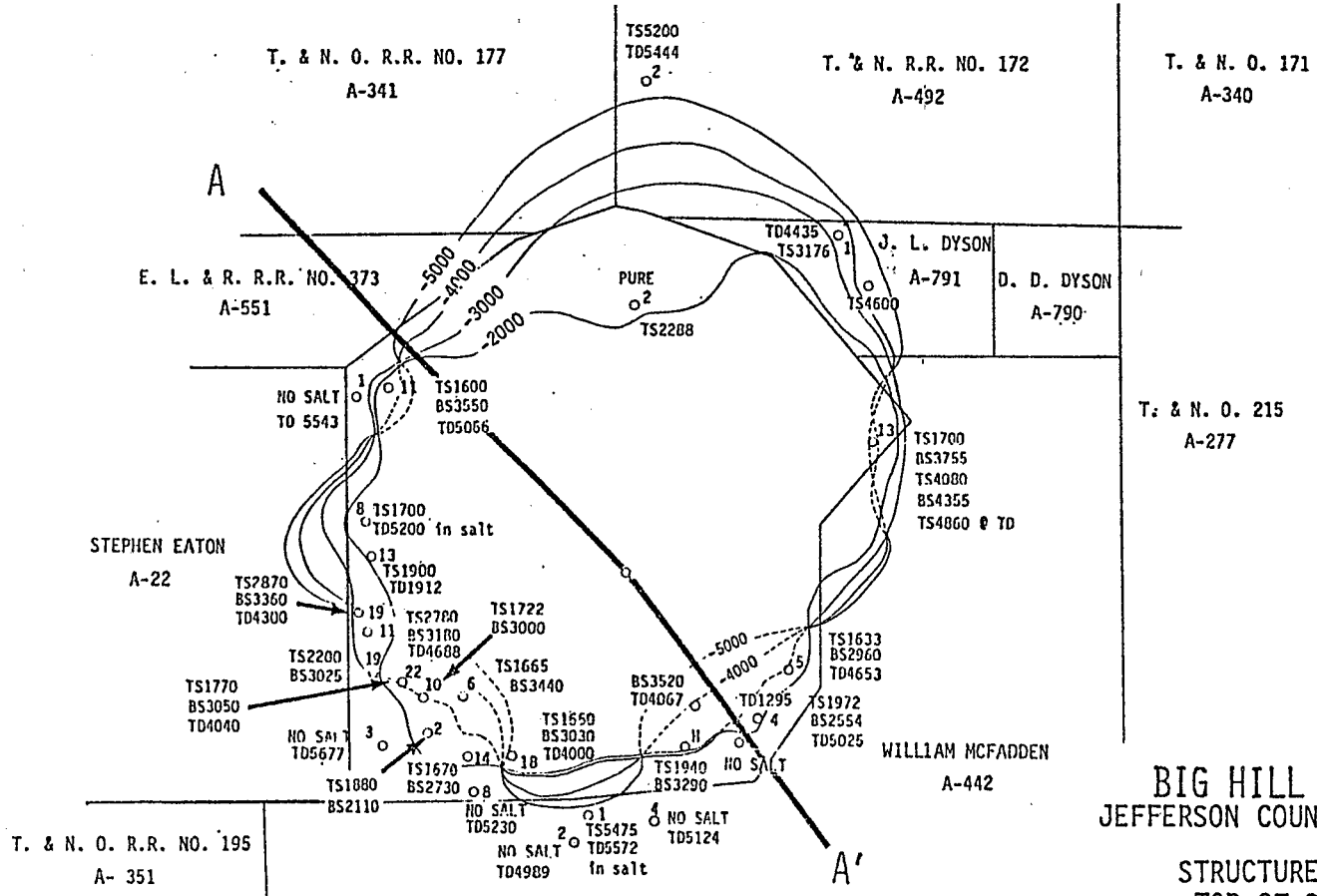

Figure B.3-37 Geologic Cross Section of Big Hill Dome.

B.3-119



BIG HILL DOME
JEFFERSON COUNTY, TEXAS

STRUCTURE MAP
 TOP OF SALT
 CONTOUR INTERVAL = 1000 FEET
 DATUM = SEA LEVEL

0 1000 2000
 FEET

Figure B.3-38 Structure Map - Top of Salt - Big Hill Dome

B.3-120

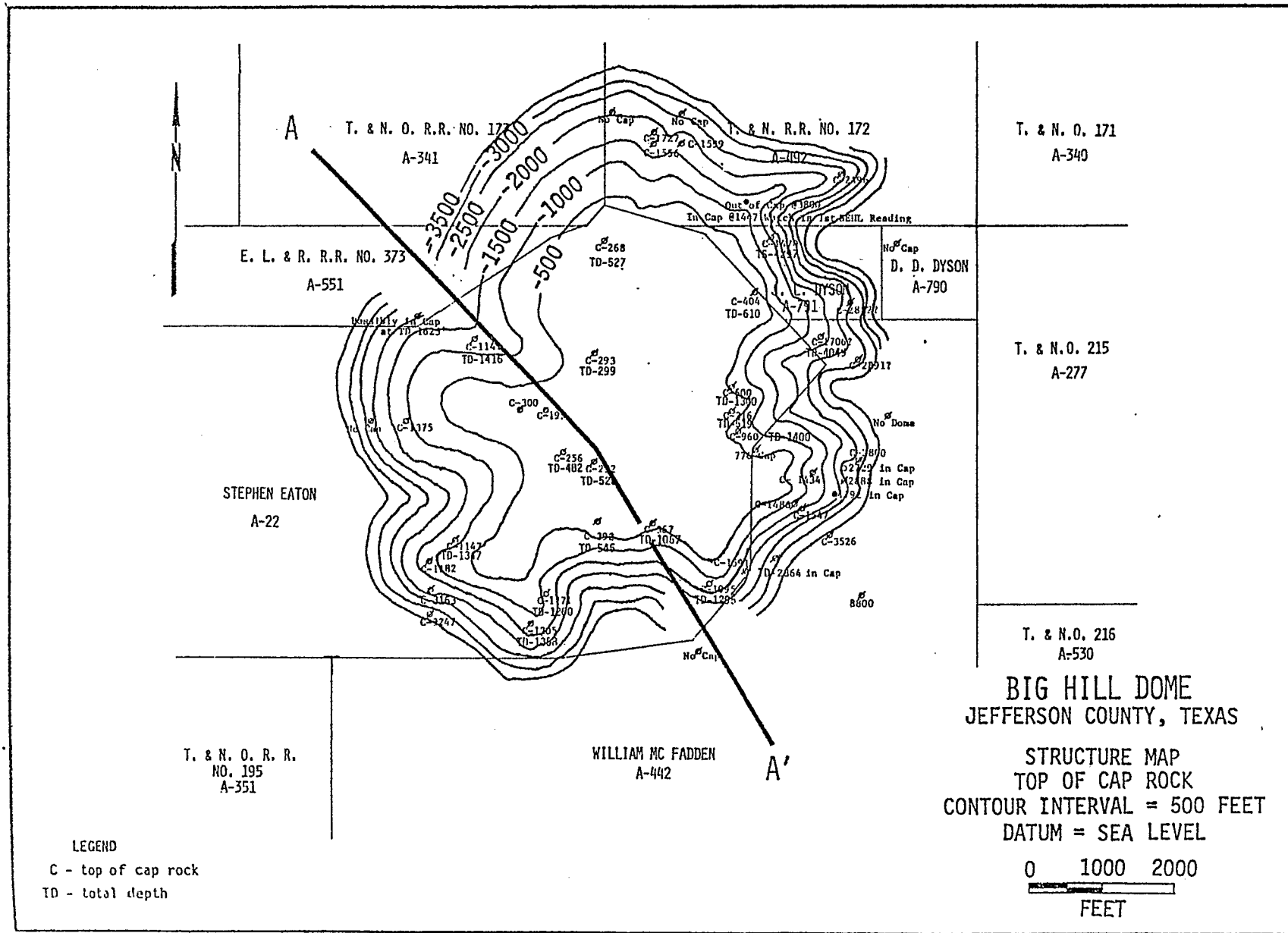

Figure B.3-39 Structure Map - Top of Cap Rock - Big Hill Dome

estimated thickness of Big Hill caprock is two or three times that usually found over Gulf Coast domes and would probably increase the difficulties of drilling.

The shallowest known salt occurs on the west perimeter at 1,600 feet below sea level, and the deepest salt top yet encountered is at 5,475 feet on the south flank. Drilling history suggests that the top of the salt lies between 1,600 to 1,700 feet below sea level.

Surface area enclosed within the 2,000 foot depth to salt contour is 507 acres, and the area confined within the 3,000 foot depth contour is about 613 acres.

However, the salt overhangs that exist on the west, southwest, southeast and east significantly decreases the area of the dome available for solution mined storage cavern construction. If those areas where known salt overhang occurs are excluded from the 2,000 foot contour, only about 382 acres of surface area are available. And in some areas, the extent of the overhang is not fully known because of the lack of drilling data.

B.3.4.1.3 Stratigraphy

Because of the irregular top the thickness of the sediments overlying the dome varies from 200 to 1,000 feet. Beaumont clay and Lafayette gravels (both formations are described in the Vinton stratigraphy discussion) overlie the dome. Unconsolidated and partially consolidated sands and shales of Pliocene, Miocene and Oligocene age extended downward to a depth below 10,000 feet off the flanks of the dome.

The thickness of Miocene age sediments is estimated at 6,000 to 6,500 feet, with the base of the Miocene indicated at about 9,500 feet below sea level. These sediments have been forced upward in the immediate vicinity of the dome by the salt piercement, as shown in the cross section in Figure B.3-37.

B.3.4.1.4 Soil Characteristics

There are three soil types overlying and surrounding Big Hill Dome: Hockley, Crowley, and Morey, Figure B.3-40 is a soil distribution map.

The Hockley silty loam overlies the salt dome site. This soil is gently undulating to nearly level. Slopes range from 1 to 3 percent however slopes of .5 percent and 5 percent do occur. Surface layers range in thickness from 14 to 30 inches. The Ph of this soil is neutral in some areas. The upper subsoil

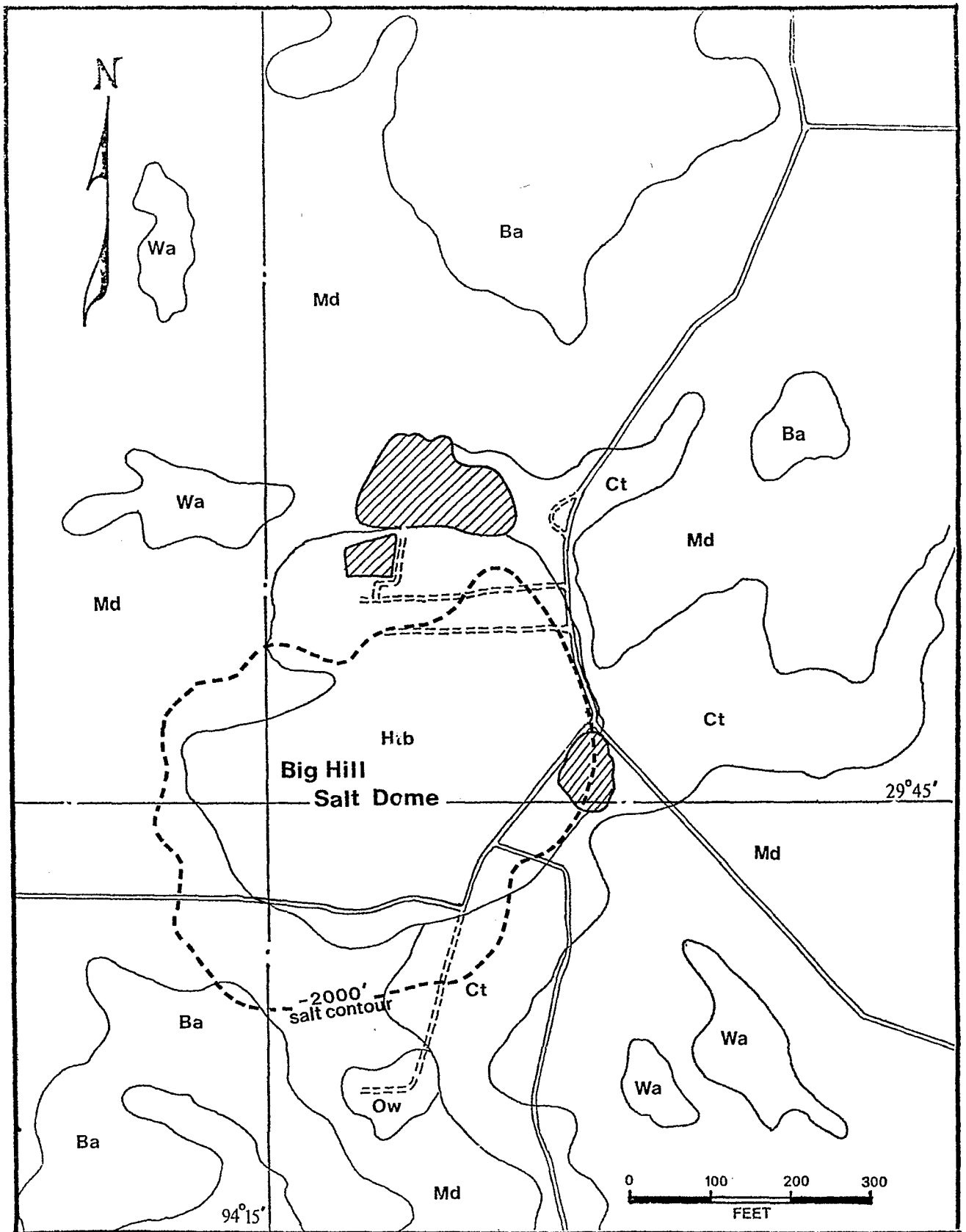

Soil Key:
 Ba - Beaumont clay Ct - Crowley silt loam Htb - Hockley silt loam
 Md - Morey silt loam Ow - Oil-waste land Wa - Waller soils

Figure B.3-40 Big Hill Soil Distribution Map.
 (Source: Crout, et al, 1965).

layers are very pale brown in places. The Hockley soil can hold moderate amounts of moisture for plant use, and it absorbs water readily. In the more nearly level parts of this soil small areas of Crowley silt loam are included in mapping such as on the entire eastern half of the dome outside of the Hockley soil.

The Crowley silt loam which occurs along the eastern flank of the dome is usually level to nearly level. Areas of morey silt loam and Hockley silt loam less than 5 acres in size are mapped as Crowley. The upper 12 inches generally has a granular structure into which water and plant roots can readily enter. The subsoil, however, is much tighter.

The Morey silt loam mapping unit occurs throughout the nearly level coast prairie part of the county. At Big Hill it surrounds the western half of the dome. The surface layer is generally silt loam, but in a few included places, it is clay loam or very fine sandy loam with few to many yellowish-brown mottles. In places the subsoil is olive-gray and mottles occupy from 5 to 20 percent of an exposed surface. In some places red and yellowish-brown mottles are mixed. Reaction of the subsoil ranges from strongly acid to moderately alkaline. Large concretions that contain calcium carbonate are common in the lower subsoil and parent materials.

Low, sandy, circular mounds, 20 to 50 feet in diameter and 1 to 3 feet high, are usually on the surface of the Morey soils. Their surface layer is gray very fine sandy loam 14 to 36 inches thick. Their subsoil is very heavy, blocky, olive-sandy clay that is mottled with various shades of yellow and brown. In most places the sandy mounds occupy from 5 to 15 percent of the mapping unit. In a few places they occupy as much as 20 percent. In some areas the soil at the base of the mounds is high in soluble salt. Where the surface layer is smoothed and salt is exposed on the surface, vegetation will not grow for several years. These spots are referred to as slick spots.

Areas less than 5 acres in size of Beaumont clay, Crowley silt loam, and Waller soils are included with Morey silt loam, in mapping. In most places these included soils occupying less than 5 percent of the mapping unit, but in some places they occupy as much as 10 percent. Also included are sizable areas of a soil that has a more friable upper subsoil than Morey silt loam. Its surface soil ranges from slightly acid to neutral.

Morey silt loam can hold moderate amounts of moisture for plant use. Common surface crusts, plowpans, and the tight subsoil make it very difficult for water to enter the soil.

B.3.4.1.5 Mineral Resources

Since oil was first produced from the Houston Oil Company well on September 1, 1923, production has been developed on all but the east rim of the salt dome. The greatest density of drilling is on the dome's southeast flank.

No attempt has been made to acquire detailed production data, but interpretation of the structure map and geologic cross section suggests that oil and gas occur on the flanks of the dome in Oligocene and Miocene sediments that are faulted or pinched out against the sides of the dome. Numerous traps have apparently been formed by the salt overhang on the southwest and south perimeter of the dome.

No known oil or gas production is located over the top of the dome in the area proposed for the storage facility.

Pure Oil Company has two solution mined LPG storage caverns on the north rim of the salt mass. These caverns, whose capacities are 326,000 and 314,000 barrels, are located along the north rim of the Stephen Eaton A-22 survey (see Figure B.3-38). One of them is reported to have a base at 3,350 and top of salt at 2,288 feet below sea level.

Despite these two caverns no active salt mining at Big Hill is reported.

There is no evidence of sulphur production or exploration at Big Hill.

B.3.4.2 Water Environment

The Big Hill dome is located in the southeastern Texas coastal zone approximately 17 miles west of Sabine Lake. The site is on the southwestern fringe of the Sabine Neches River basin. The land in the immediate vicinity of the dome is dry, but extensive marshlands are encountered approximately one mile south of the site. Annual rainfall in the area averages approximately 47 inches, slightly less than amounts recorded for the Louisiana sites.

The surface water system, which is described in Section B.3.4.2.1, represents the primary source of leaching/displacement water and also the primary site for brine disposal. The subsurface water system, which is discussed in Section B.3.4.2.2, constitutes a secondary source of water.

B.3.4.2.1 Surface Water Systems

The general arrangement of the surface water system in the vicinity of Big Hill is shown in Figure B.3-41. The dome is situated between Taylor Bayou and its tributaries (6-1/2 miles to the north), and the ICW and Spindletop Ditch (4-5 miles to the south). Spindletop Marsh and Salt Bayou Marsh are situated between the dome and the two manmade streams. Surface drainage in the vicinity of the site is generally to the south and east (Robertson, 1977). The Gulf of Mexico lies 4 miles beyond the ICW. A summary of the surface water bodies and their characteristics is provided in Table B.3-17.

Subsequent discussion of the surface water system is divided as follows:

- Taylor Bayou and tributaries
- Intracoastal Waterway and Spindletop Ditch
- Spindletop Marsh and Salt Bayou Marsh
- Salt Bayou, Star Lake and Clam Lake
- Gulf of Mexico

Taylor Bayou and Tributaries

Taylor Bayou is a tidal river which originally emptied into Sabine Lake, but which currently empties into the Sabine-Neches Canal near its southern junction with the ICW. The bayou receives inflow from nine significant tributaries (including

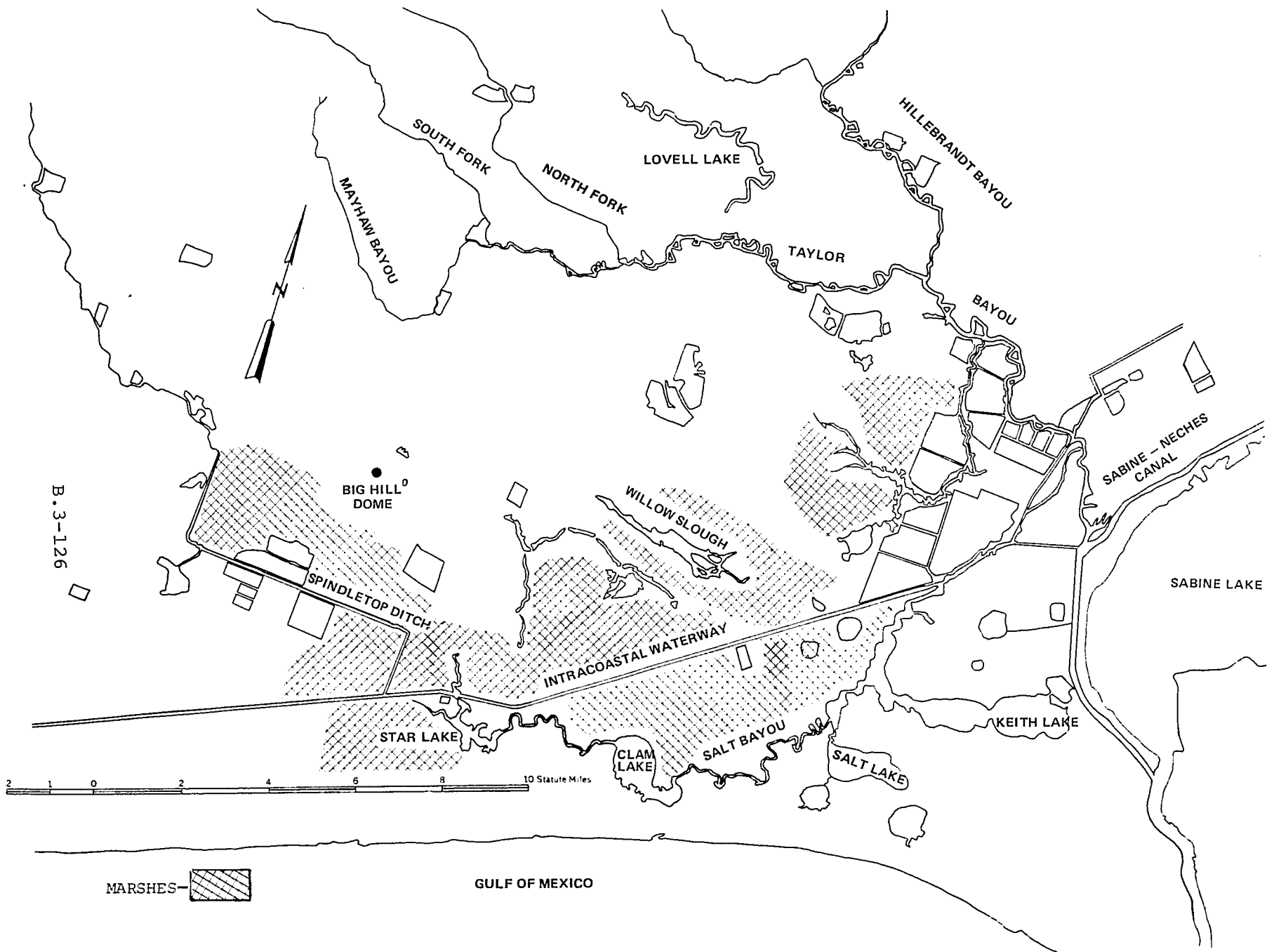

Figure B.3-41 Big Hill Surface Water System

Table B.3-17. Surface Water Bodies in the Vicinity of Big Hill Dome

<u>Body of Water</u>	<u>Distance, Mi</u>	<u>Direction</u>	<u>Direction of Flow</u>	<u>Connections</u>
Big Hill Bayou	13.0	NE	E	Shallow Prong Lake
Big Hill Reservoir	13.5	NE	I*	Shallow Prong Lake
Clam Lake	10.3	SE	I	Lake Bayou (Five Mile Cut)
Coffee Bean Slough	9.0	NE	I	Salt Bayou (Ten Mile Cut)
Hillebrandt Bayou	16.0	NNE	S	Taylor Bayou
Intracoastal Waterway	6.5	S	Generally E	Spindletop Ditch, Salt Bayou, Sabine-Neches Canal
Little Lake	3.7	S	I	-
Lovell Lake	13.5	NNE	I	-
Mayhaw Bayou	5.0	N	NE	South Fork Taylor Bayou
North Fork Taylor Bayou	8.0	N	E	Taylor Bayou
Salt Bayou	5.0	SE	SE	Intracoastal Waterway, Star Lake
Shallow Prong Lake	13.5	NE	E	Big Hill Reservoir, Big Hill Bayou
South Fork Taylor Bayou	6.7	NE	E	Mayhaw Bayou, Taylor Bayou
Spindletop Bayou	7.0	W	SE	Spindletop Ditch
Spindletop Ditch	4.7	S	SE	Intracoastal Waterway
Star Lake	8.0	SE	I	Intracoastal Waterway
Taylor Bayou	12.0	NE	E	Sabine-Neches Canal
Willie Slough Gully	6.0	E	E	-
Willow Slough	6.0	E	E	-

*I means indeterminate flow direction.

Mayhaw Bayou, South Fork, North Fork, and Hillebrandt Bayou) and has a watershed area of approximately 464 miles (Texas Water Quality Board, 1975). The bayou has its headwaters in the agricultural areas of Jefferson County where rice farming and cattle production predominate. The lower portion of the bayou drains more urbanized areas before entering the Sabine-Neches Canal. A salt water barrier is located approximately one mile upstream of the mouth of the bayou.

Heavy BOD discharges by municipalities and industrial users occur in Taylor Bayou particularly during low-flow periods. High BOD loadings also result from agricultural runoff associated with cattle grazing operations. Irrigation for rice causes some herbicide and pesticide runoff.

Volumetric flow data for Taylor Bayou and its tributaries are provided in Appendix D. These data display considerable variations with respect to daily flow. In 1975 the maximum flow rate near LaBelle was 5,380 ft³/sec on June 1 (USGS, Texas 1975). The minimum flow could not be determined, but the data suggests that flow drops to near zero quite frequently.

The Texas State Water Quality Standards for Taylor Bayou are included in Appendix D. According to these standards the bayou above the salt water barrier is intended for recreation (contact and noncontact) and the propagation of fish and wildlife.

Water and sediment quality data were collected at 7 stations along the bayou and its tributaries. The results of a comparison of these data with appropriate standards and criteria are summarized in Tables B.3-18 and B.3-19.

Intracoastal Waterway and Spindletop Ditch

The segment of the ICW under consideration extends from the Sabine-Neches Canal southwestward along the Gulf Coast toward Galveston. The waterway is approximately 250 feet wide with a controlled depth of 12 feet. Flow in the waterway is influenced by winds and tides but generally the direction of flow is to the northeast. Spindletop Ditch joins the ICW approximately 5-1/2 miles southeast of the site. The ditch is roughly 150 feet wide with a depth of less than 6 feet.

The Texas State Water Quality Standards for the ICW are included in Appendix D. According to these standards the waterway is intended for noncontact recreation and the propagation of fish and wildlife.

Table B.3-18 . Summary of Water Quality Analysis

Body of Water	Sample Station ⁺	Date	Violates State Standards	Exceeds EPA* Numerical Criteria	Poses a Possible Problem
Mayhaw Bayou	21	07-24-74			Phosphates
South Fork, Taylor Bayou	20	07-24-74			Phosphates
North Fork, Taylor Bayou	15	07-14-74			Phosphates, Low Dissolved Oxygen
Taylor Bayou	14	07-24-74	Low Dissolved Oxygen	Low Dissolved Oxygen	Phosphates
Hillebrandt Bayou	6	07-24-74	Low Dissolved Oxygen	Low Dissolved Oxygen	Phosphates
Taylor Bayou	2	07-24-74	Low Dissolved Oxygen	Low Dissolved Oxygen	Phosphates
Taylor Bayou	1	07-24-74	Low Dissolved Oxygen	Low Dissolved Oxygen	Phosphates

⁺The location of all sample stations are shown in Figure D.8-1.

* Freshwater aquatic life, provided in Appendix D.3.

Table B.3-19 Summary of Sediment Analysis

Body of Water	Sample Station +	Date	Exceeds Recommended Criteria *
Taylor Bayou	14	7-23-74	COD, TKN, Zinc, and PCB's
"	2	7-23-74	TKN, Zinc, and PCB's
"	1	7-23-74	TKN, Oil and Grease, Lead and Zinc
Hillebrandt Bayou	6	7-23-74	COD, TKN, Lead, Zinc and PCB's

+The location of all sample stations are shown in Figure D.8-1.

*Included in Appendix D.3.

A limited amount of water quality data are available for the ICW and is included in Appendix D. Two of the sampling stations involved were located at the junction of the ICW with the Sabine-Neches Canal and 2-1/2 miles southwestward along the waterway. Samples from other stations in the ICW near the end of Big Hill Road and in Spindletop Ditch were collected and analyzed by the Texas Water Quality Board for use in this report. The results of a comparison of the available data with appropriate state standards and federal criteria are summarized in Table B.3-20 and Table B.3-21.

Spindletop Marsh and Salt Bayou Marsh

Approximately one mile south of Big Hill dome lies Spindletop Marsh. This marsh is part of a large coastal wetlands area which also includes Salt Bayou Marsh to the southeast of the site, and Willow Slough Marsh to the east. These wetlands naturally extend to within 1/2 mile of the Gulf of Mexico, but due to the presence of the ICW and Spindletop Ditch, circulation of water in these marshes has been restricted, especially in the marshes north of the ICW. As a result water quality in these marshes has suffered. One of the contributing factors in the deterioration of water quality is the runoff from rice farms in the area.

Salt Bayou, Star Lake and Clam Lake

Salt Bayou originates in Salt Bayou Marsh approximately 3-1/2 miles southeast of the Big Hill site. The bayou naturally flows to the southeast until it reaches Star Lake. Beyond this lake the bayou flows to the east approximately 3 miles, at which point Clam Lake is encountered. The bayou then continues eastward, ultimately emptying into the ICW. The presence of flood gates at the intersection of the bayou with the ICW near Big Hill restricts the natural flow in the Bayou. Results of water quality sampling of Salt Bayou performed by the Texas Water Quality Board are included in Appendix D. Comparison with state standards and federal criteria are summarized in Table B.3-20 and Table B.3-21.

Shallow Coastal Waters of the Gulf of Mexico near Big Hill

The Gulf of Mexico would be used to dispose of brine from Big Hill, and lies approximately 10 miles southeast of the dome. The proposed brine disposal site lies approximately 5 miles offshore in shallow water 30-35 feet deep. The bottom composition in this area is silty clay (Bureau of Land Management, 1975).

The salinity of the water is affected by the discharge of the Sabine River Basin through Sabine Pass 17 miles to the northeast. In Sabine Pass the salinity is on the order of 28 ppt (Fisher et al, 1973). Similar values have been reported 10 miles to

Table B.3-20 Summary of Water Quality Analysis

Body of Water	Sample Station ⁺	Date	Violates State Standards	Exceeds EPA* Numerical Criteria	Poses a Possible Problem
Intracoastal Waterway (Texas Segment)	Approximately 2 1/2 miles SSW of junction with Sabine-Neches Canal	1971	Low Dissolved Oxygen	Low Dissolved Oxygen	Percent Saturation
ICW	Juntion with Sabine-Neches Canal	1971		Phosphorus	Nitrogen
ICW	B	1977		pH, Phosphorus	Lead
Salt Bayou	C	1977		Phosphorus, Ammonia Nitrogen	Zinc
Salt Bayou	A	1977		Phosphorus	Zinc
Spindetop Ditch	D	1977		Phosphorus, Ammonia Nitrogen	Lead, Zinc

B.3-132

⁺The locations of sample stations are shown in Figure D.5-1 and in Figure D.8-1

* Marine water constituents, provided in Appendix D.3.

Table B.3-21 Summary of Sediment Analysis

Body of Water	Sample Station ⁺	Date	Exceeds Recommended Criteria*
ICW	B	1977	COD, TKN
Salt Bayou	C	1977	COD, TKN
Salt Bayou	A	1977	COD, TKN
Spindletop Ditch	D	1977	COD, TKN, oil and grease

⁺The locations of sample stations are shown in Figure D.8-1

* Marine and Freshwater constituents, provided in Appendix D.3.

the south near the seaward end of the Sabine Bank Channel (U. S. Army Corps of Engineers, Galveston, 1975). Surface salinities at the Big Hill disposal site, as measured from September to December 1977, ranged from 18 to 28 ppt.

As in the case of the Louisiana coastal waters of the Gulf, surface currents in the area are variable, being strongly affected by winds, tides and other conditions. Mean surface currents 30 miles to the west of the disposal site tend to set to the west with a drift of less than 1 knot as shown in Figure B.3-12 (Bureau of Land Management, 1975d). Approximately 50 miles to the southeast of the site the surface current also sets to the west with a slightly greater drift. Winds 45 miles south of the disposal area tend to blow from the southeast at 11.6 knots. Additional detailed oceanographic data are provided in a related report (NOAA, 1972). Finally, a detailed description of site specific physical oceanography determined during a field study for this EIS, is presented in Appendix U.2.

B.3.4.2.2 Subsurface Water Systems

Big Hill is a piercement salt dome which rises to within 200 feet of the surface. The dome penetrates an undetermined thickness of Chicot aquifer, which normally is as deep as -1200 feet msl in the local area (Wesselman, 1971). Fresh water occurs in the Chicot aquifer to a depth of less than -100 feet msl immediately above the dome and to a depth of -200 feet msl less than 2 miles northwest of the dome. Slightly saline water is present beneath the fresh water of the Upper Chicot to a depth of -300 feet msl at Big Hill and to -500 feet msl northwest of the dome at Winnie. Saline water is probably introduced into the shallower sands of the Chicot aquifer by dissolution of salt from Big Hill dome or from vertical movement of deeper saline water around the flanks of the dome (Wesselman, 1971).

The major centers of ground water withdrawal in the Lower Chicot aquifer are at Baytown (40 miles west of Big Hill) and the Beaumont-Port Arthur area (approximately 20 miles northeast of Big Hill) (Wesselman, 1971). The decline in water levels in this aquifer at Beaumont-Port Arthur is sufficient to affect water levels at Big Hill and produce a southeast to eastward movement of ground water from Big Hill.

In the Upper Chicot aquifer the principal center of ground water withdrawal influencing water movement at Big Hill is located at Winnie, about 8 miles northwest of Big Hill, as mapped in 1966, the water level at Winnie was more than 30 feet below sea level due to industrial, municipal, and irrigation pumping. The water level at Big Hill had declined a few feet from the 1941 levels to sea level in 1966 (Wesselman, 1971).

Table B.3-21 Hydraulic Characteristics of the Upper Chicot Aquifer near Big Hill
(Wesselman, 1973)

WELL	DATE	COEFFICIENT OF TRANSMISSIBILITY (GPD PER FT)	COEFFICIENT OF PERMEABILITY (GPD PER FT ²)	COEFFICIENT OF STORAGE	SPECIFIC CAPACITY (GPM PER FT OF DRAWDOWN)	REMARKS
PT-64-15-704	Sept. 22, 1966	21,300	207	-	-	Recovery observation well.
PT-64-15-705	-	21,600	216	-	1.7	Recovery pumped well; 23-hour test.

Sedimentary Sequence Above Big Hill Dome (Wesselman, 1973)

Well PT-64-15-705

Owner: Pure Oil Co.
Driller: Layne-Texas Co.

	THICKNESS (FEET)	DEPTH (FEET)
Topsoil	2	2
Clay	30	32
Shale, blue and seashells	277	309
Sand, cut good	163	472
Shale	8	480

Chemical Analyses from Water Wells Near Big Hill Dome (Wesselman, 1973)

WELL	DEPTH OR PRODUCING INTERVAL (FT)	DATE OF COLLECTION	SILICA (SiO ₂)	IRON (Fe)	CALCIUM (Ca)	MAGNESIUM (Mg)	SODIUM (Na)	POTASSIUM (K)	BICARBONATE (HCO ₃)	SULFATE (SO ₄)	CHLORIDE (Cl)	FLUORIDE (F)	NITRATE (NO ₃)	BORON (B)	DISSOLVED SOLIDS	HARDNESS AS CaCO ₃	SODIUM ADSORPTION RATIO (SAR)	RESIDUAL SODIUM CARBONATE (RSC)	SPECIFIC CONDUCTANCE (MICROMHOS AT 25°C)	pH
705	415	Sept. 23, 1966	--	--	--	--	--	--	--	--	920	--	--	--	--	--	--	--	3,890	--
705	415	Sept. 23, 1966	--	--	--	--	--	--	--	--	960	--	--	--	--	--	--	--	4,010	--
705	415	Sept. 23, 1966	--	--	--	--	--	--	--	--	960	--	--	--	--	--	--	--	4,010	--
705	415	Sept. 23, 1966	18	.04	72	26	782	6.9	660	96	980	.4	1.5	.47	2,310	286	20	5.09	4,090	7.3

Ground water withdrawals at Winnie have two major results. First, the salt water-freshwater interface in the Upper Chicot aquifer are drawn northward toward Winnie. Secondly, as a result of the removal of ground water and the reduction in aquifer pressure, some land subsidence is likely. This adds to the subsidence already caused by oil and gas removal at Big Hill.

The hydraulic characteristics of the Upper Chicot aquifer were determined using two wells at Big Hill. The results are presented in Table B.321.

B.3.4.3 Air Quality

B.3.4.3.1 Existing Air Quality

Since on-site monitoring has not been conducted at the proposed Big Hill expansion site, the regional air quality levels established in Section B.2.3.3 are used to predict the existing air quality at the Big Hill site. Based on these data, the ambient concentrations of NHMC and photochemical oxidant are predicted to be high and might exceed the existing standards. All other pollutants are expected to be in compliance with the applicable standards.

B.3.4.3.2 Projected Air Quality

Projection of SPR activities at Big Hill indicate that the nitrogen oxides, carbon monoxide, and particulate concentration are expected to be in compliance with standards in the following 10 years. However, sulfur oxides and NMHC are expected to exceed the ambient air quality standard due to the increased marine terminal operation. The high NMHC concentration would result in the projection of oxidant level exceeding standards.

B.3.4.4 Background Ambient Sound Levels

Background noise levels in and around the alternative SPR site at Big Hill salt dome expansion are typical of a secluded essentially flat area. The area is similar in geography and surrounding land use to that described for the SPR region. Noise assessment of ambient levels for the region are contained in Section B.2.4.

B.3.4.5 Species and Ecosystems

The proposed Big Hill storage facility and all of its associated pipeline and system components would be located within or off-shore of Jefferson County, Texas. The ecosystems which occur within this area, and which would be potentially impacted by construction and operation of the facility, have been discussed in detail in Section B.2.5.2.4 of this report. The following discussion will break down the proposed components and will discuss which of these ecosystems would be associated with these components. The ecosystem distribution of the Big Hill project area is shown in Figure B.3-42. Aquatic ecosystems for the project area are shown in Figure B.3-43.

Big Hill salt dome is located in southwest Jefferson County in a dry area just north of the band of marshland which borders the coast (see Figure B.3-42). The elevation of the land which surrounds Big Hill is 5 to 10 feet higher than the marshland elevations.

Three pipeline systems would be associated with the facility design, both primary and alternative routes have been proposed for each pipeline. Since these alternative routes would traverse different environmental assemblages. They have been indicated in Figure B.3-43.

B.3.4.5.1 Environmental Setting of the Displacement/ Leaching Water System

Raw water for leaching new caverns and for the displacement of stored oil will be supplied from the ICW which is located 5 miles south of Big Hill dome. Two pipeline routes have been proposed which would connect the storage facility with the ICW. They would follow the two proposed rights-of-way for the brine disposal system through prairie, brackish marsh, and intermediate marshland (see Section B.3.4.5.2), and would impact the same species and biologic assemblages.

Both the primary raw water pipeline (Route #3) and the alternate route (Route #6) would originate in an intake station which would be built on an inlet dredged in the ICW.

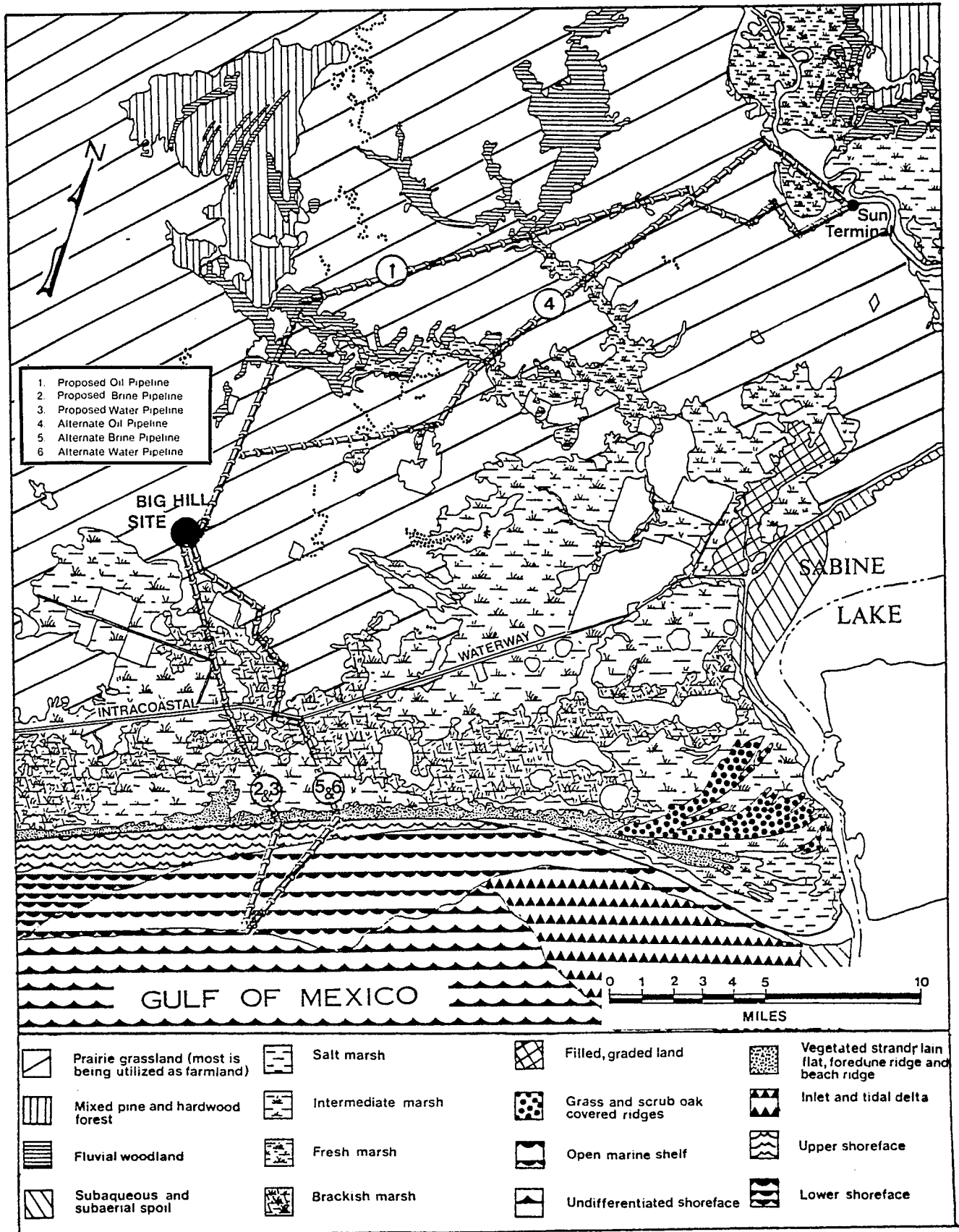

FIGURE B.3-42 ECOSYSTEM DISTRIBUTION—BIG HILL PROJECT AREA

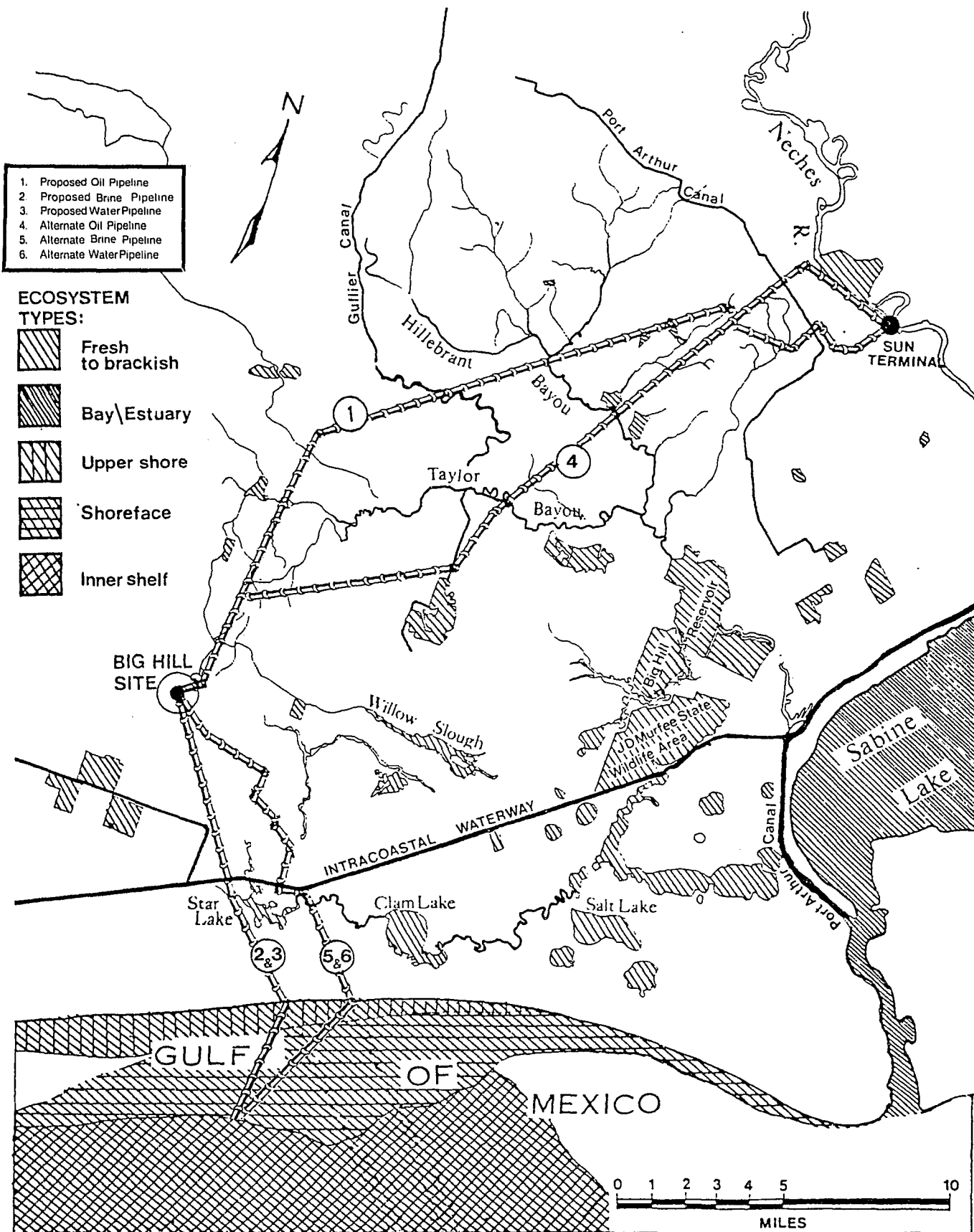

FIGURE B.3-43 AQUATIC ECOSYSTEMS—BIG HILL PROJECT AREA

Source: Fisher 1973

The vegetation along the banks of the ICW is dependent upon several factors. These factors include time since disturbance, drainage and characteristics of the adjacent landscape. The area at which pipeline Route #3 would reach the ICW is an area of brackish marsh. Waterway embankments bordering brackish marsh support vegetation different from the marsh itself, although species common to the marsh are present. Common species include marsh elder, eastern brackcharis, wiregrass (Spartina patens), Bermuda grass (Cyndon dactylon), blackberry, and roseau.

The area surrounding the point at which alternate Route #6 would reach the ICW embankment is a grassland area. The vegetation along this embankment would include bluestem (Andropogon spp.), Indian grass (Sorghastrum spp.), and other species listed in Table I, Appendix K.

Animals which are common to the embankment areas are small rodents and the waterfowl which utilize the surrounding marshlands for wintering or for permanent residence. These species are discussed in Section B.2.5.2.5.

B.3.4.5.2. Environmental Setting of Brine Disposal System

According to the primary facility design, the proposed pipeline, Route 2, for the brine disposal system at Big Hill would cross 9.2 miles of dry land and marsh and 4 miles of open water.

The first 5.2 miles of pipeline would extend in a southeasterly direction from the dome until it intersects with the ICW. The ecosystems affected would be 1.2 miles of prairie grasslands and 4 miles of brackish and intermediate marsh and the dredge disposal areas and spoil banks of the ICW (see Section B.2.5.2). This four miles of marsh crossing include the Salt Bayou and a dirt road. After crossing the ICW, the pipeline would proceed another 3.5 miles over brackish and salt water marshes. During this leg, the pipeline would bisect a branch of Star Lake, a brackish water lake. The last .5 miles of terrestrial brine pipeline would cross State Route 87 on its way to the coastal prairie and beach.

The same plant and animal species discussed in Section B.3.4.5.3 are also found on the segments of prairie grassland in the areas of the brine disposal pipeline.

Two distinct marsh ecosystems (brackish and intermediate) are associated with the primary brine disposal pipeline system. The brackish-water marsh vegetation includes: marsh hay cordgrass (Spartina patens); big cordgrass (S. cynosuroides), and rushes (Juncus spp.). The animals related to this same environment are furbearers such as nutria, muskrat, and mink. Also various waterfowl species utilize this area as a wintering ground. Intermediate marsh vegetation not only includes cordgrass and rushes, but also contains cattails (Typha latifolia), and coastal sacahuista (Spartina spartinae). Similar animals of the brackish-water marsh ecosystems also dwell in the intermediate marshes.

On reaching the Gulf of Mexico, the brine disposal pipeline would extend out 4 miles to a depth of approximately 30 feet. Three distinct open water environments would be traversed in the process. They are: upper shoreface; shoreface; and shelf.

The three open water ecosystem would have similar types of planktonic forms. Diatoms and dinoflagellates would be the prominent phytoplankters, while the zooplankton would be made up of various copepods, ostracods, cladocerans, and meroplankters. These planktonic organisms would be the primary and secondary producers which form the basis of the food chain in the open water environment.

Various clams, urchins, snails, and starfish would be represented in the benthos of these three open water environments. Different species would be found in each sector due primarily to salinity and temperature preferences. The majority of these animals would be sessile adult forms which have planktonic larvae. Commercially important brown and white shrimp (Penaeus aztecus and P. setiferus) and blue crab (Callinectes sapidus) would also be found in these environments. These crustaceans utilize the offshore grounds to spawn, so both adult and immature stages would be found in these waters. Many different species of fish would pass through these ecosystems due to the natural abundance of nutrients and food. Various trophic levels would be represented, such as: Planktonic feeders (menhaden - Brevoortia patronus), benthic feeders (croaker - Micropogon undulatus), and predatory feeders (bluefish - Pomatomus saltatrix).

The alternative brine disposal pipeline route, Route 5, would be slightly longer than the primary route. The alternative is 16.5 miles as opposed to 13.2 miles, but would traverse fewer miles of marshlands.

Like the primary route, the alternative pipeline would start in a southeasterly direction along a light duty road for approximately 1 mile. It would then turn east while still following the course of the road for another mile, crossing a small canal in the process. These first 2 miles would cross a prairie grassland environment. The route would then break away from the road and follow another unimproved dirt road for 2 miles still over prairie grasslands. It then would proceed in a more southerly direction across .5 miles of salt-water marsh. While still following the road, the pipeline would cross 2 more miles of prairie grassland, and then head toward another unimproved dirt road for .5 miles across a brackish-water marsh. At this point, the route proceeds due south along the unimproved dirt road for about .5 miles over prairie grasslands. The pipeline would then cover 4 miles to the Gulf, crossing both brackish and salt water marshes on its way to the Gulf of Mexico. During this stretch, the route crosses the ICW and Salt Bayou. Finally, like the primary route, the pipeline bisects State Route 87 and coastal beach before extending 5 miles into the Gulf. The same 3 open water environments would be affected for the alternative brine disposal pipeline. They are upper shoreface; shoreface, and shelf. The only different ecosystem affected by the alternative brine disposal pipeline would be salt marsh. Vegetation of the salt marsh ecosystem includes cordgrass (Spartina alterniflora), glasswort (Salicornia sp.) and saltwort (Batis maritima). Various species of duck, geese, and other water fowl dwell and feed in these areas. For a detailed description of biologic assemblages and dynamics observed during a field study conducted at the proposed brine disposal sites, for this EIS, see Appendix U.4.

B.3.4.5.3 Environmental Setting of the Site

Big Hill dome is a moderately large dome which lies about 9 miles from the Gulf of Mexico in an area typical of the prairie grassland community (see Section B.2.5.2.4). This area is primarily used for pastureland but farming is being conducted in the area. The dome itself rises more than 25 feet above the surrounding plain to a maximum elevation of 37 feet above sea level and is located approximately one mile north of a band of brackish and intermediate marshes which border the Gulf.

The dome is covered by tall prairie grass species including bluestem (Andropogon spp.), Indiangrass (Sorghastrum spp.) and Johnson grass (Sorghum halepense). Some introduced pasture species may also be present at the site. These would include ryegrass, clover, and dallisgrass. Animal species which are common to the prairie and pasture ecosystems include rodents such as the cotton rat and the plain's pocket gopher, and fowl such as prairie chicken, quail, and bobwhite. The coyote is the main predator in this ecosystem, feeding on rodents and other small mammals.

Roadways exist in the area and on the dome itself. Since the dome is used for grazing, little secondary succession has occurred, but a small stand of oaks is located on the northeast corner of the dome. Agricultural lands are found to the northeast and directly to the west of the dome. A large grassy area lies to the northeast of the dome.

B.3.4.5.4 Oil Distribution System

Crude oil will be transported between Big Hill and the Sun Terminal in Nederland, Texas via one 36-inch pipeline. Two pipeline routes have been proposed. Both routes would travel in a northeast direction and would cross prairie grassland, agricultural, and pastureland ecosystems. The alternative route (#4) is more northern and inland, and crosses the higher and drier woodland ecosystems.

The primary oil distribution pipeline (Route #1) would be 26 miles long. The pipeline would leave the site in a northeast direction and cross approximately 2 miles of prairie and pastureland. Species are those common to the prairie and pasture ecosystems. The route would then cross the Willow Slough Canal, a fresh, rain fed water body which is dry except during periods of high rainfall. The canal feeds into Willow Slough Marsh, which lies to the east of the pipeline route, and which is an extensive intermediate marsh. Species common to all these systems are described in Section B.2.5.2.4.

The pipeline route continues in a northeastern direction, crossing, and paralleling several roads, for almost 9 miles. This entire stretch of the route crosses what was at one time prairie grassland, but which is now predominantly farmland. Rice is the primary crop (see Section B.2.5.2.4). This land is dry with elevations exceeding those of the southern marsh areas. The most significant animal species which are common to these croplands are the waterfowl which winter in the rice fields and in the surrounding marshes. A large man-made water body lies to the east of the pipeline route just south of Route 73.

The route would proceed to cross Taylor Bayou and approximately .5 miles of the fresh water marsh which borders it at this point. At this point, Taylor Bayou is a fresh water stream, with salinities lower than 0.2 ppt (Texas Water Quality Board 1974).

The pipeline route would continue through another band of agricultural land 3.5 miles wide. This band is broken only by a small patch of fluvial woodland (see Section B.2.5.2.4) and a small canal. Pecan, hickory and live oak dominate the fluvial woodland

vegetation. Although this patch of vegetation is too small to support white tailed deer, gray squirrel, raccoon, and swamp rabbits are common.

The route crosses Hillebrant Bayou and one mile of surrounding fresh water marshes near Viterbo Reservoir. Continuing through 5 miles of agricultural lands and 1 mile of industrial development, the route would cross the Port Arthur canal, a fresh water body. The remainder of the route crosses what are primarily industrial and residential areas, with little vegetation except introduced tree species.

The final 2.5 miles of the route would follow the spoil banks of two cutoff channels of the Neches River. This spoil bank is bounded on the north by the McFadden Bend and Smith Bluff cutoffs, and on the south by a large area of freshwater swamp. Fresh swamps are wooded and the most common genera include cypress (Taxodium spp.), tupelo and gum (Nyssa spp), oaks (Quercus spp.), and hickory (Carya spp.). Nutria and mink are furbearers common to the area and are preyed upon by bobcat, red and gray foxes. The species common to this ecosystem are detailed in Section B.2.5.2.4.

The alternative oil distribution pipeline (Route 2) traverses many of the same ecosystems as Route 1. Its course, however, is more northern, or inland and rather than crossing marshlands, it crosses the higher and dryer fluvial woodland ecosystems which are the extension of the Taylor and Hillebrant Bayou marsh-swamp systems. The plant species which dominate the fluvial woodland ecosystem are more mesic than those which are common to swamps. Fluvial woodland species include pecan, hickory and several species of oaks. These species are listed in Appendix K, Table K.7-1, Section B.2.5.2.4.

This pipeline would leave the site and travel in a northeasterly direction through 6.5 miles of agricultural lands. The route would cross South Fork Taylor Bayou, and one mile of the surrounding fluvial woodlands. It would continue through .75 miles of agricultural land and then cross North Fork Taylor Bayou, its associated fluvial woodland ecosystem, and a narrow band of swamp.

The pipeline would parallel existing roadways and pipeline routes for most of the remainder of the route. It would traverse another 3.2 miles of farmland, cross Lovell Lake, which is actually a fresh water slough, and an additional 2.75 miles of agricultural land.

The route would then cross Hillebrant Bayou with its surrounding 1.25 miles of fluvial woodland and swamp.

The final 11 miles of pipeline would cross farmland, industrial development, and residential areas. The route would border oh, but not enter, fresh water marsh at the termination of the route.

B.3.4.6 Natural and Scenic Resources

Big Hill salt dome and its associated pipeline are within a relatively homogeneous land area. Most of the land is either under cultivation or used as grazing land. As such, the scenic value of the area can be described as a rural coastal Texas agricultural setting.

B.3.4.7 Archaeological, Historical and Cultural Resources

There are no recorded archaeological sites within 1/2 mile of the Big Hill salt dome and the proposed oil and brine lines. There are also no sites listed or proposed for inclusion in the "National Register of Historic Places" in Big Hill project area (National Park Service, 1977). A recently completed cultural resources survey of proposed oil and brine lines indicated that because of the great distance of these lines and the numerous environmental zones through which they pass, would make it likely that historic sites would lie near the impact area (Thomas, et al., 1977). During this same survey Big Hill dome was randomly sampled and although no sites were encountered, further testing would be recommended to affirm that no sites were present in the proposed storage site area.

B.3.4.8 Socioeconomic Characteristics

B.3.4.8.1 History and Cultural Patterns

In the early 1500's when Spanish and French explorers arrived along this part of the Texas coast, the region was inhabited by several tribes of Indians, the Attakapas, the Deadoses, and the Arkokisas. Over the course of the 1800's, Mexico won its independence from Spain, and Texas won its independence from Mexico. Sixteen years after its admission to the Union as a state, Texas joined the Confederacy in the Civil War. Not much of the Civil War was fought on Texas soil, but in one noteworthy battle, the Federal Navy gunboats arrived at the Sabine Pass and attacked the Confederate forces in Southeast Texas.

After the Civil War, settlements appeared along the Sabine and Neches Rivers. The railroad connecting the east Texas coast to the interior plains states arrived in the 1890's, marking the start of industrialization in the area. Further impetus toward growth was added when oil was discovered in Jefferson County in 1901.

Marked contrasts appear within the County. The northern sections are highly developed, with urban centers concentrated along the Neches River and Sabine Lake, and suburban areas stretching south and west. The Gulf coast section contains vast expanses of marsh wilderness that remain inaccessible by road. The people of these rural areas share a culture that is distinctively Texan in its progressiveness, individualism, and its enthusiasm for wide open spaces.

B.3.4.8.2 Population

The Big Hill site is in a rural part of Jefferson County. While the county census in 1970 recorded 244,773 people, the part of the county in which Big Hill is located, Sabine Pass subdivision, had a population of 1,486. This was an increase of 12.6 percent over the 1960 population of 1,320 for the subdivision. Over 99 percent of the population of Jefferson County lives in the northern part of the country, away from the Gulf coast. The population is concentrated in the Beaumont-Port Arthur region along the Neches River and Sabine Lake.

The proposed pipeline routes from Big Hill to Nederland would cross the LaBelle subdivision. Unlike the Sabine Pass subdivision which is primarily comprised of marshlands, the LaBelle subdivision is an area of farms, villages, and small

towns. Its population was 2,444 in 1960, and grew at a rate of 41.3 percent to a total of 3,453 in 1970. A sparsely-populated section of the Port Neches-Nederland subdivision would also be crossed by the pipelines. The subdivision, as a whole, is a rapidly-growing area. From a 1960 population of 24,582, it grew 34.6 percent to a 1970 level of 33,086.

Towns within a 10-mile radius of Big Hill are shown in Figure B.3-44. These are: Hamshire, Winnie, and Stowell. Fannett lies just beyond this radius, but is within five miles of the proposed pipeline corridors to Nederland. All of these are unincorporated communities.

Hamshire is a community with a population estimated to be about 350. There is a post office and 5 business establishments in the village.

The population of Winnie was registered as 5,512 by the 1970 census. It is the largest of these communities, and has about 83 commercial establishments and a medical center with a 60 bed capacity.

Stowell is two miles south of Winnie, at the junction of Routes 124 and 65. Both Winnie and Stowell are in Chambers County. Stowell has a population of 1,592, and 6 commercial establishments.

Fannett is a community of about 100 persons which lies on Route 124 about midway between Winnie and Beaumont.

These communities are centers of social and commercial activity for the surrounding rural areas. Farmers of this region of Jefferson and Chambers Counties make their living primarily from growing rice and raising beef cattle.

Population Projections

The proposed storage site at Big Hill and its associated pipelines would lie within the South East Texas Planning Region, which is comprised of Jefferson and Orange counties. Population projections for the region were formulated by the South East Texas Regional Planning Commission in 1972. The Jefferson County subdivisions which would be affected by the proposed

B.3-148

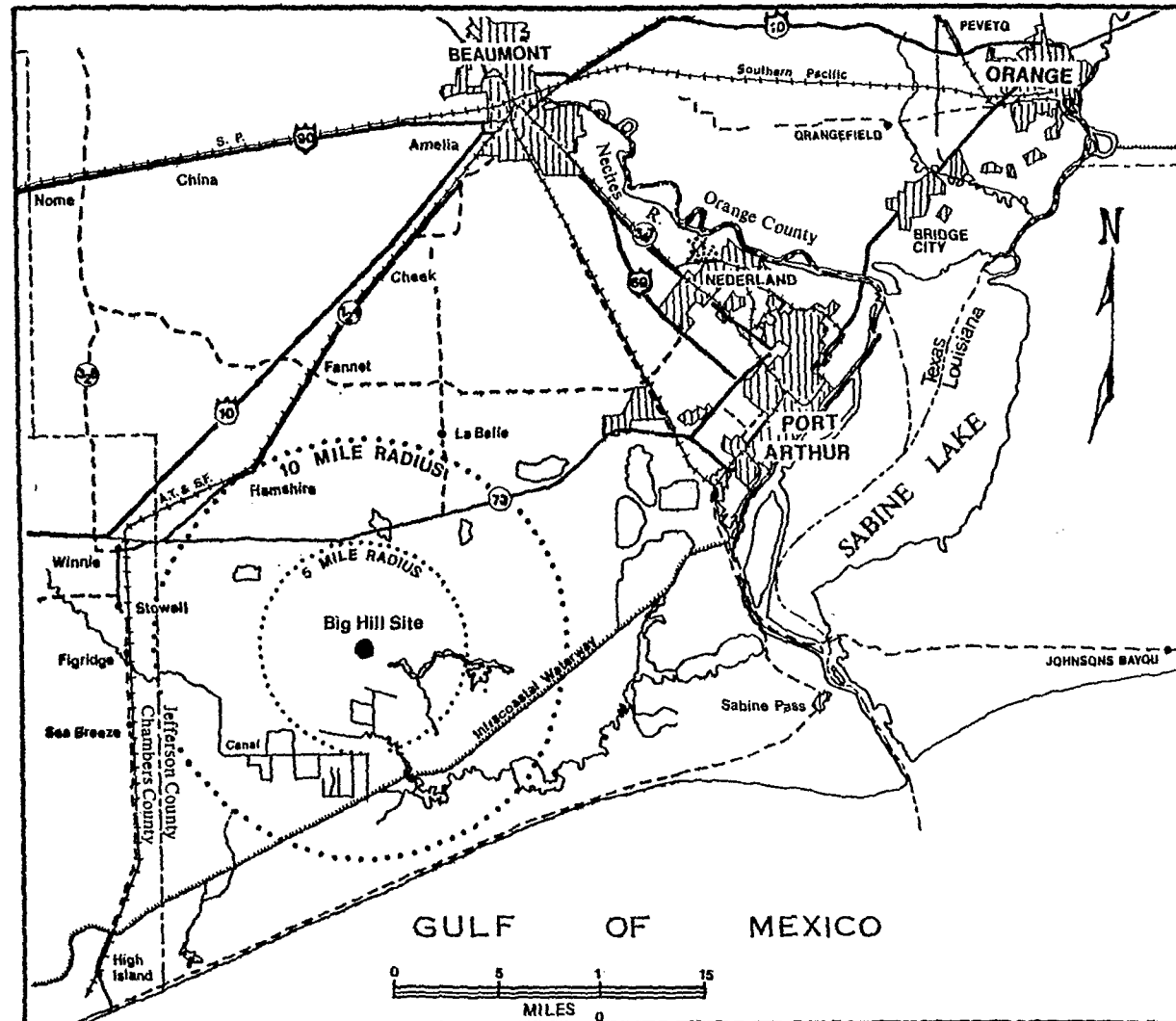

Figure B.3-44 Towns and Cities Around the Big Hill Site

project are as follows:

<u>Subdivisions</u>	<u>1960</u>	<u>1970</u>	<u>1980</u>	<u>1990</u>
Sabine Pass	1,320	1,486	1,600	1,800
LaBelle	2,444	3,453	3,650	3,900
Port Neches-Nederland	24,582	33,086	34,600	37,150

These projections indicate that the rapid growth experienced between 1960 and 1970 is not expected to continue. The figures are locally considered to be conservative and reflective of policy considerations that take into account desirable population density levels.

B.3.4.8.3 Land Use Patterns

The Big Hill site is in an area used for grazing cattle and producing oil and natural gas. Land use patterns in this portion of Jefferson County are not expected to change substantially in the future, due to limitations imposed by the marshy terrain and the lack of major roadways between Routes 73 and 87. There is sufficient land area available north of Route 73 to absorb urban expansion from the Beaumont-Port Arthur metropolitan centers.

Both pipeline routes to Nederland cross a rice farming region. The southeastern route would cross Taylor Bayou within half a mile of the Port Arthur Country Club, and would cross Route 365, which has scattered groups of residential buildings along the highway. The northwest pipeline route would cross through two areas which are currently sparsely populated, but are expected to be more intensively developed as residential land by 1990. These are the areas southeast of Fannett just before the pipeline turns eastward, and the portion of land northeast of the point where the pipeline would cross Hillebrandt Bayou in the Lovell Lake-Hillebrandt area.

Both of these alternate pipeline routes would cross Memorial Highway (Routes 287, 96, and 69) and Twin City Highway (Route 347) which are the main traffic arteries between Beaumont and Port Arthur. The first route continues northeastward to the spoil bank along the Neches River, then follows the bank to the Sun Terminal. The land crossed by this route is expected to be developed for industrial purposes. The second route would turn south and east after crossing the Southern Pacific Railroad tracks and cross through land presently designated as Nederland Extraterritorial Area. Although it is outside the present Nederland City Limits, it is being developed as residential and commercial property.

B.3.4.8.4 Transportation

The northern part of Jefferson County has an extensively developed system of roads and highways. The area south of Big Hill is composed primarily of wetlands and there are practically no roads along a belt 10 to 12 miles inland from the Gulf Coast, except for Texas Highway 87 which runs right along the shore.

Main highway arteries leading toward the site are Interstate 10 and Texas Highway 124 leading southeast out of Beaumont, and Highway 73 leading westward from Port Arthur. The interstate route has a daily average traffic volume of over 14,000 vehicles. Highway 124, which goes through Fannett and Hampshire, bears a daily average of about 2,000 vehicles. The unpaved road leading to Big Hill intersects with Highway 73 where the daily average traffic amounts to about 3,000 vehicles. This unpaved road also provides access to several rural dwellings along the roadway, and the traffic count near its junction with 73 recorded a volume of 175 vehicles daily (Texas Highway Department, 1973).

The salt dome lies about 6 miles north of the Intracoastal Waterway. Approximately 9,500 to 9,800 self-propelled vessels travelled in each direction through this section of the Waterway in 1975 (Corps of Engineers). This compares with the passage of about 7,500 such vessels each way along the Neches River from Beaumont to the Sabine Lake, and 5,600 to 5,700 self-propelled vessels in and out of the Sabine Pass which connects Sabine Lake with the Gulf of Mexico.

There are several landing strips for small planes in the area of Winnie, Texas, about 8 miles west of Big Hill. The major airports served by commercial airlines, however, are located at Nederland and Beaumont, 20 to 30 miles north of the site.

A number of different railroad companies operate in the area around Big Hill, providing primarily freight service. The Atchison, Topeka and Santa Fe Railway has a line running north and south just 8 miles west of the salt dome. The railway goes through Beaumont which is also served by the Kansas City Southern, Missouri Pacific, and Southern Pacific.

There are many pipelines in the area, and a large number of them would be crossed by the proposed pipeline leading from the oil storage site to the terminal in Nederland. A Sun Oil pipeline leads away from the eastern side of the dome northeastward across Highway 73 (Oil and Gas Journal Pipeline Map 1973).

B.3.4.8.5 Housing and Public Services

The nearest community offering a significant number of available housing units is Port Arthur, which is 25 miles northeast of the site. Beaumont is a major metropolitan area only 30 miles from the site, and is considered to be within commuting distance. The vacancy rate of rental units in Port Arthur and Beaumont ranges from 11 to 13, indicating a capacity to absorb a substantial number of people migrating into the region.

(Further details of the housing accommodations in these two cities is given in Table B.3-22 of the regional description, Section B.2.8.).

Although Winnie is in the neighboring county, it is the nearest town of sufficient size to provide commercial services to project workers. It has a health clinic that provides medical services to the surrounding rural settlements. Protective services for the project site, however, would be under the jurisdiction of Jefferson County.

Main highway arteries leading toward the site are Interstate 10 and Texas Highway 124 leading southeast out of Beaumont, and Highway 73 leading westward from Port Arthur. The interstate route has a daily average traffic volume of over 14,000 vehicles. Highway 124, which goes through Fannett and Hamshire, bears a daily average of about 2000 vehicles. The unpaved road leading to Big Hill intersects with Highway 73 where the daily average traffic amounts to about 3000 vehicles. This unpaved road also provides access to several rural dwellings along the roadway, and the traffic count near its junction with 73 recorded a volume of 175 vehicles daily (Texas Highway Department, 1973).

B.3.4.8.6 Economy

The economy of the area around Big Hill is based on agriculture and oil and gas production. The lands bordering the coastal marshes are used as pasture for grazing cattle. Beef production is a major industry throughout Texas, and different regions tend to specialize in a particular facet of the industry, such as the feedlot fattening or the slaughtering of the beef. East Texas, including the Big Hill area, is a region where much of the breeding occurs for the beef herds.

The two alternate pipeline corridors leading to port facilities at Nederland cross extensive rice farming areas. Rice ranks third in value among Texas crops, exceeded by cotton and sorghum. The irrigated rice fields are highly mechanized, and air planes are used for planting, fertilizing, and applying insecticides and herbicides. A record high yield was achieved in 1971 when 5,100 pounds of rice per acre was harvested. The average price per 100 pounds of rice was \$6.44 in 1972, then more than doubled in 1973 to a high of \$14.80. The 1974 price fell to \$11.00 per 100 pounds (Texas Almanac 1976-1977).

Oil has been produced in Jefferson County since the discovery of the Spindletop reserve in 1901. The Spindletop field is still producing. Total crude oil production in the county in 1974 totaled over 5.5 million barrels, averaging about 15,000 barrels per day. Petroleum refining is the major industry in Beaumont and Port Arthur.

Manufacturing, wholesale and retail sales, and large port facilities are concentrated in the urban area in the north-eastern part of the county. Crude petroleum is the major import from both foreign and domestic sources. Gasoline and fuel oil are the main exports.

B.3.4.8.7 Government

The major cities in Jefferson County have home rule. Beaumont received its home rule charter in 1913, Port Arthur in 1915, and Nederland in 1955. All three cities are governed by a city council with a city manager. Each also has a mayor. Construction within the cities must be authorized by a building permit. Fees for the issuance of such permits netted for Beaumont in 1974 over \$28 million, for Port Arthur about \$6.5 million and for Nederland approximately \$1.5 million.

In Texas, each county establishes its own ratio of assessed valuation to actual value and its tax rate for the assessment of property taxes. For Jefferson County, the ratio is set at 15 percent, and the total assessed valuation of all taxable property in 1974 was over \$535 million. Neighboring Orange County had an assessed valuation of about \$190 million, and Chambers County (which is primarily rural) of nearly \$203 million.

Each county is governed by a "commissioners court" which acts as an administrative body, not a judicial court. There are four commissioners in the court, each elected from one of four separate precincts within the county. The commissioners court is headed by a county judge elected by the county population at large.

The State has been divided into 24 regional councils which have the responsibility to establish plans for unified development, efficiency, and the promotion of the economy of their area. Jefferson County is served by the South East Texas Regional Planning Commission, along with Orange County. Chambers County, which lies about 8 miles west of the Big Hill site, is served by the Houston-Galveston Area Council.

REFERENCES

- Allen, O.M., 1975a, Louisiana landings annual summary 1973. National Marine Fisheries Service, NOAA, in cooperation with the Louisiana Wildlife and Fisheries Commission.
- _____, 1975b, Louisiana landings annual summary 1974. National Marine Fisheries Service, NOAA, in cooperation with the Louisiana Wildlife and Fisheries Commission.
- _____, 1976, Louisiana landings annual summary 1975. National Marine Fisheries Service, NOAA, in cooperation with the Louisiana Wildlife and Fisheries Commission.
- American Hospital Association, 1975, American Hospital Association guide to the health care field.
- Andrews, D.I., 1960, The Louann salt and its relationship to Gulf Coast salt domes. Gulf Coast Assoc. Geo. Soc. Transactions, vol. 10, pp. 215-240.
- _____, 1961, Indigneuous Pleistocene production in offshore Louisiana. Gulf Coast Assoc. Geo. Soc. Transactions, vol. 11, pp. 109-119.
- Aycock, D., 1976, U.S. Fish and Wildlife Service, personal communication (November).
- Bailey, S., 1976, Warden - Sydney Island, personal communication (November).
- Barrett, B.B., 1970, Water measurements of coastal Louisiana. Louisiana Wildlife and Fisheries Commission.
- _____, 1971, Cooperative Gulf of Mexico estuarine inventory and study, Louisiana, phase II - hydrology and phase III - sedimentology. Louisiana Wildlife and Fisheries Commission.
- A.H. Belo Corporation, 1977, Texas almanac and state industrial guide 1976-1977. Dallas, Texas.
- Bobo, J.R. and Charlton, J.M. (eds.), 1974, Statistical abstract of Louisiana. Division of Business and Economic Research, College of Business Administration, University of New Orleans, New Orleans, Louisiana.
- Bollich, C., 1976, personal communication (November).

- Boykin, R.E., 1972, Texas and the Gulf of Mexico. Department of Marine Resources Information, Center for Marine Resources, Texas A & M University, College Station, Texas.
- Bureau of Census, 1967, Census of governments 1966-1967. U.S. Department of Commerce, Washington, D.C.
- _____, 1970a, Census of housing. U.S. Department of Commerce, Washington, D.C.
- _____, 1970b, Census of population. U.S. Department of Commerce, Washington, D.C.
- _____, 1972, Census of governments 1971-1972. U.S. Department of Commerce, Washington, D.C.
- _____, 1974, Census of agriculture, preliminary report for Jefferson County, Texas. U.S. Department of Commerce, Washington, D.C.
- Bureau of Land Management, 1975a, Chart of distribution of sediment types northern Gulf of Mexico - 1970. U.S. Department of the Interior, Washington, D.C.
- _____, 1975b, Final environmental statement - proposed increase in oil and gas leasing on the outer Continental Shelf. U.S. Department of the Interior, Washington, D.C., vol. 1.
- _____, 1975c, Tropical storms in the Gulf of Mexico, Atlantic Coast 1954-1975. Visual no. 2, U.S. Department of the Interior, Washington, D.C.
- _____, 1975d, Outer Continental Shelf, Western Gulf of Mexico, surface currents. Visual No. 6. U. S. Department of the Interior, Washington, D.C.
- Bushby, J.D., 1976, Hackberry Waterworks, personal communication (May).
- Calhoun, J., Calhoun, M., and Kempe, H., 1975, Louisiana almanac 1975-1976. Pelican Publishing Company, Gretna, Louisiana.
- Cameron Parish Home Demonstration Club, 1966, Points of interest and historical data on the Johnson Bayou area of Cameron Parish.
- Carsey, J.B., 1950, Geology of Gulf coastal area and Continental Shelf. Bulletin AAPG, vol. 34, no. 3, pp. 361-385.
- Chabreck, R.H., Joanen, T., and Palmisano, A.W., 1968, Vegetative type map of the Louisiana coastal marshes. Louisiana Wildlife and Fisheries Commission, New Orleans, Louisiana.

- Chabreck, R.H., 1970, Marsh zones and vegetative types in the Louisiana coastal marshes. Unpublished Ph.D. dissertation - Louisiana State University, Baton Rouge, Louisiana, 113 pp.
- _____, 1972, Vegetation, water and soil characteristics of the Louisiana coastal region. Bulletin no. 664, Louisiana State University, Agricultural Experiment Station, 72 pp.
- Corcoran, E.F., 1972, Data interpretation report of the study of the distribution and concentration of trace metals and pesticides of the Florida territorial sea of ESCAROSA. ESCAROSA 1-71. Contract #CCC-04-71 between SUSIO and FCCC.
- Crout, J.D., Symmank, D.G., and Peterson, G.A., 1965, Soil survey of Jefferson County, Texas. U.S. Department of Agriculture, Soil Conservation Service.
- Dames and Moore, 1975, Environmental analysis of Louisiana offshore oil port. Prepared for LOOP, Inc., New Orleans, Louisiana.
- Darnell, R.M., 1959, Studies on the life history of the blue crab (Callinectes sapidus) in Louisiana waters. Transactions of the American Fisheries Society, vol. 88, pp. 294-304.
- Daugherty, F.M., 1952, The blue crab investigation, 1949-50. Texas Journal of Science, 1: 77-84.
- Davis, W.B., 1974, The mammals of Texas. Texas Parks and Wildlife Department, Austin, Texas.
- Dickinson, G., 1953, Geological aspects of abnormal reservoir pressure in Gulf Coast Louisiana. Bulletin AAPG, vol. 37, no. 2, pp. 410-432.
- Dunham, F., 1972, A study of estuarine-dependent industrial fishes. Louisiana Wildlife and Fisheries Commission, technical bulletin 4.
- Dyer, J.C., 1917, The Lake Charles Attakapa cannibals, period 1817-1820. Unpublished M.S., Tulane Library, New Orleans.
- Earles, J.M., 1976, Forest statistics for southeast Texas counties. U.S. Department of Agriculture, Forest Service Resource bulletin 50-58,
- Farley, O.H., 1977, Supervisory Fishery Reporting Specialist, personal communication.

- Federal Power Commission, 1975, Draft environmental impact statement, Calcasieu LNG project. Trunkline LNG Co., Docket no. CP 74-138 et al.
- FEA, 1977a, Final environmental impact statement, West Hackberry salt dome. Strategic Petroleum Reserve Office.
- _____, 1977b, Supplement, Final environmental impact statement, West Hackberry salt dome. Strategic Petroleum Reserve Office.
- Fisher, W.L., Brown, L.F., McGowen, J.H., and Groat, C.G., 1973, Environmental geological atlas of the Texas Coastal Zone, Beaumont-Port Arthur Area. Bureau of Economic Geology, University of Texas at Austin, Austin, Texas.
- Gagliano, S.M., 1967, Occupation sequence of Avery Island. Louisiana State University Press, Baton Rouge, Louisiana.
- Gaidry, W.J., III and White, C.J., 1973, Investigations of commercially important penaeid shrimp in Louisiana estuaries. Louisiana Wildlife and Fisheries Commission, technical bulletin 8.
- Gibbens, D., 1977, Louisiana Archaeological Survey and Antiquities Commission, personal communication (February).
- Gibson, J. J., 1976, Archaeological survey of the Mermentau River and Bayous Nezpique and Des Canes, Southwest Louisiana, LaFayette, Louisiana. University of Southwestern Louisiana Press.
- Gifford, F.A., Jr., Pasquill, F., and Markee, E.H., 1960, Use of routine meteorological observations for estimating atmospheric dispersion. Nuclear Safety 2(2) (December).
- Gillespie, M.S., 1971, Section II, Analysis and treatment of zooplankton of estuarine waters of Louisiana. In Perret, W.S. (ed.), Phase IV, Biology Cooperative Gulf of Mexico Estuarine Inventory and Study, Louisiana, Louisiana Wildlife and Fisheries Commission, pp. 109-175.
- Guidry, B., 1976, Sulphur Waterworks, personal communication (May).

- Gunter, G., 1950, Seasonal population changes and distribution as related to salinity of certain invertebrates of the Texas coast, including the commercial shrimp. Publ. Inst. Mar. Sci., University of Texas, Austin, Texas, 2: 7-51.
- _____, 1967, Some relationships of estuaries to the fisheries of the Gulf of Mexico. In Lauff, G.H. (ed.), Estuaries, American Assoc. for Advancement of Science, Washington, D. C., publ. no. 83, pp. 621-638.
- Halbouty, M.T. and Hardin, G.C., Jr., 1956, Genesis of salt domes of Gulf Coastal Plain. Bulletin AAPG, vol. 40, pp. 737-746.
- Halbouty, M.T., 1976, Salt domes Gulf region United States and Mexico. Gulf Publishing Company, Houston, Texas.
- Hales, A.L., Helsley, C.E., and Nation, J.B., 1970, Structural study on Gulf Coast of Texas. Bulletin AAPG, vol. 54, no. 11, pp. 2040-2057.
- Hanna, M.A., 1934, Geology of the Gulf Coast salt domes, problems of petroleum geology. Bulletin AAPG, pp. 629-678.
- Harder, A.H., 1960, Geology and ground-water resources of Calcasieu Parish, Louisiana. U.S. Geol. Survey Water-Supply Paper 1488, 102 pp.
- Harder, A.H. et al., 1967, Effects of ground-water withdrawal on water levels and salt-water encroachment in southwestern Louisiana. Department of Conservation, Louisiana Geological Survey, and Louisiana Department of Public Works, Baton Rouge, Louisiana, Water Resources Bulletin, no. 10.
- Hedgpeth, J.W., 1954, Bottom communities of the Gulf of Mexico. U.S. Fish and Wildlife Service, fishery bulletin, 55(89): 203-214.
- Henley, A.S., 1925, Big Hill salt dome, Jefferson County, Texas. Bulletin AAPG, vol. 9, no. 3, pp. 590-595.
- Hershman, J.M., 1973, Louisiana wetlands prospectus: conclusions, recommendations, and proposals of the Louisiana Advisory Commission on Coastal and Marine Resources. Louisiana Advisory Commission on Coastal and Marine Resources, Baton Rouge, Louisiana.

- Hildebrand, H.H., 1954, A study of the brown shrimp (*Penaeus aztecus*) grounds in the western Gulf of Mexico. Publ Inst. Mar. Sci., University of Texas, Austin, Texas, 3:2, pp. 229-366.
- Holzworth, G.C., 1972, Mixing heights, wind speeds, and potential for urban air pollution throughout the contiguous United States. Environmental Protection Agency, Office of AIR Programs, Research Triangle Park, North Carolina.
- _____, 1974, Meteorological episodes of slowest dilution and contiguous United States. National Environmental Research Center, Office of Research and Development, U.S. Environmental Protection Agency, Research Triangle Park, North Carolina.
- Howe, G.M., 1974, Tornado path sizes. J. Applied Meteorology, Vol. 13.
- Howe, H.V. and McGuirt, J.H., 1935, Salt domes of Cameron and Vermillion Parishes. Louisiana Geological Survey, bulletin 6, pp. 73-166.
- Hutchinson, G.E., 1967, A treatise on limnology, vol. II, introduction to lake biology and the limnoplankton. John Wiley and Sons, Inc., New York.
- Imperial Calcasieu Regional Planning and Development Commission, 1974, Existing land use study.
- _____, 1975, Future land use plan for 1990.
- Jirik, C.J. and Weaver, L.K., 1976, A survey of salt deposits in salt caverns and their relevance to the Strategic Petroleum Reserve. Federal Energy Administration Strategic Petroleum Reserve.
- Jones, P.H. and Turcan, A.N., 1954, Geology and ground water resources of southwestern Louisiana. Louisiana Department of Conservation, Louisiana Geological Survey, bulletin no. 30, Baton Rouge, Louisiana.
- Jones, P.H. et al., 1956, Water resources of southwestern Louisiana. U.S. Geological Survey, water supply paper no. 1364.
- Jones, P.H., 1969, Hydrology of Neogene deposits in the northern Gulf of Mexico Basin. Louisiana Water Resources Research Institute, bulletin GT-2.

- Kehle, R.O., 1968, Notes from a seminar on Gulf Coast structure. Houston, Texas.
- Kelly, J., 1977, Soil Conservation Service Office, personal communication.
- Knox, J.W. and Oakes, J.Y., 1976, Year round grazing with a beef herd. Sixteenth annual livestock producer's day report, vol. 16, Louisiana state University, Animal Science Department, Baton Rouge, Louisiana.
- Krumbein, W.C. and Sloss, L.L., 1963, Stratigraphy and sedimentation. W.H. Freeman and Company, San Francisco, California.
- Kupfer, D.H., 1963, Structure of salt in Gulf Coast domes. Symposium on Salt, Northern Ohio Geological Society, Inc., Cleveland, Ohio, pp. 104-123.
- Lake Charles American Press, 1976, editorial (7 February).
- Lane, J.A. and Tveton, 1974, A birder's guide to the Texas coast. Land Photography, P.O. Box 19401, Denver, Colorado.
- Lansdberg, H., 1969, Physical climatology. Gray Printing Co., Inc., DuBois, Pennsylvania.
- Lantz, K.E., 1970, An ecological survey of factors affecting fish production in a Louisiana natural lake and river. Louisiana Wildlife and Fisheries Commission, Baton Rouge, Louisiana.
- Levine, S. N., 1968, (Ed.) Selected papers on desalination and ocean technology. Dover publications.
- Lott, E., 1977, Rare Plant Study Center, University of Texas at Austin, personal communication (March).
- Louisiana Department of Highways, 1971, 1971 Traffic flow map, Cameron Parish. Traffic and Planning Section.
- Louisiana State Parks and Recreation Commission, 1974, Outdoor recreation plan.
- Louisiana State University, 1974, 1974 Statistical abstract of Louisiana. Division of Business and Economic Research.
- Lowery, G., 1974a, Mammals of Louisiana. Louisiana State University, Baton Rouge, Louisiana.
- _____, 1974b, Louisiana birds. Louisiana State University Press, Baton Rouge, Louisiana.
- Lyles, J., 1976, Lake Charles Water Company, personal communication (May).

- Margry, P., 1876-1886, Decouvertes et etablissements des francais dans l'ouest et dans le sud de l'Amerique septentrionale (1614-1754). Memoires et documents originaux. 6 vols. Paris.
- Markee, E.H., Jr. et al., 1966, Climatology of the National Reactor Testing Station. Environmental Science Services Administration.
- Martinez, J.D., 1976, Geologic reconnaissance of the northeast Texas salt dome basin. In National Waste Terminal Storage Program Progress Report for period April 1, 1975 to September 30, 1976, Office of Waste Isolation, Union Carbide Corporation, Nuclear Division, Oak Ridge, Tennessee.
- Munson, T., 1976, Louisiana State Tourist Development Commission, personal communication (December).
- National Climatic Center, 1975, Local climatological data 1973-1975. Asheville, North Carolina.
- National Park Service, 1977. National register of historic places. U. S. Department of the Interior, Washington, D.C. Federal Register, vol. 42, no. 21, pp. 6198-6362.
- Netherland, Sewell and Associates, Inc., 1976, Geologic study of the interior salt domes of northeast Texas salt dome basin to investigate the suitability for possible storage of radioactive waste material as of May 1976. Prepared for UCC-MD Office of Waste Isolation, no. Y/OWI/SUB-76/99929.
- Newcomb, W.W., Jr., 1961, The Indians of Texas, from prehistoric to modern times. University of Texas Press. Austin, Texas.
- Newton, M.B., Jr., 1972, Atlas of Louisiana. Department of Geoscience, Louisiana State University, Baton Rouge, Louisiana, miscellaneous publication 72-1.
- NOAA, 1968, Climate atlas of the United States. U.S. Department of Commerce, Environmental Science Services Administration, Environmental Data Service.
- _____, 1972, Environmental guide for the U.S. Gulf Coast.
- _____, 1973, Climatological data - Louisiana. U.S. Department of Commerce, Washington, D.C., vol. 78, no. 3.
- _____, 1974a, Climatological data - Louisiana. U.S. Department of Commerce, Washington, D.C., vol. 79, no. 13.

- _____, 1974b, Earthquake history of the U.S. U.S. Department of Commerce, Washington, D.C., publication 41-1.
- _____, 1975a, Tidal current tables 1976: Atlantic coast of North America. U.S. Department of Commerce, Washington, D.C.
- _____, 1975b, Tide tables 1976, high and low predictions, east coast of North and South America including Greenland. U.S. Department of Commerce, Washington, D.C.
- _____, 1976a, Current fisheries statistics, Texas landings, Jan-Aug 1976. U.S. Department of Commerce, Washington, D.C.
- _____, 1976b, Fisheries of the United States. National Marine Fisheries Service, U.S. Department of Commerce, Washington, D.C., Current Fishery Statistics no. 6900.
- _____, 1977, Report to Federal Energy Administration Strategic Petroleum Reserve program salt dome storage, analysis of brine disposal in the Gulf of Mexico, 2: West Hackberry. U.S. Department of Commerce, Environmental Data Service, Washington, D.C.
- Nowlin, W.D., 1971, Water masses and general circulation of the Gulf of Mexico. *Oceanology* 6(2): 28-33.
- NWRC, 1964a, STAR program, Baton Rouge, Louisiana, January 1955 - December 1964, job number 14291. National Climatic Center, Asheville, North Carolina.
- _____, 1964b, STAR program, Galveston, Texas, January 1956 - December 1960, job number 14432. National Climatic Center, Asheville, North Carolina.
- _____, 1964c, STAR program, Lake Charles, Louisiana, January 1966 - December 1970, job number 50886. National Climatic Center, Asheville, North Carolina.
- _____, 1964d, STAR program, New Orleans, Louisiana, January 1967 - December 1971, job number 51018. National Climatic Center, Asheville, North Carolina.
- Oberholser, H.C., 1974, The bird life of Texas. University of Texas Press, Austin, Texas.
- O'Neal, A. and Scova, 1971, The effect of dieldrin on water quality. *World Dredging and Marine Construction*, 7(14), pp. 24-31.
- O'Neil, T. and Linscombe, G., no date, The fur animals, the alligator, and the fur industry in Louisiana. Louisiana Wildlife and Fisheries Commission.

- Parker, T.J. and McDowell, A.N., 1955, Model studies of salt dome tectonics. Bulletin AAPG, vol. 39, no. 12, pp. 2384-2470.
- Pasquill, F., 1962, Atmospheric diffusion. D. van Nostrand, Ltd., pp. 204-214.
- Penfound, W.R. and Hathaway, E.S., 1938, Plant communities in the marshland of southeastern Louisiana. Ecological Monographs 8: 1-56.
- Pennell, 1935, The Scrophulariaceae of eastern temperate North America. Academy of Natural Sciences Phila. Monograph no. 1, p. 383.
- Perret, W.S. et al., 1971, Section I, Fishes and invertebrates collected in trawl or seine samples in Louisiana estuaries. In Perret, W.S. (ed.), Phase IV, Biology, Cooperative Gulf of Mexico Estuarine Inventory and Study, Louisiana, Louisiana Wildlife and Fisheries Commission, pp. 41-105.
- Pollard, J.F., 1973, Experiments to Re-establish historical oyster seed grounds and to control the southern oyster drill. Louisiana Wildlife and Fisheries Commission, technical bulletin no. 6, 82 pp.
- Public Affairs Research Council of Louisiana, Inc., 1973a, Statistical profile of Calcasieu Parish. Baton Rouge, Louisiana.
- _____, 1973b, Statistical profile of Cameron Parish. Baton Rouge, Louisiana.
- Read, M., 1976, President - Sabine Audubon Society, personal communication (November).
- Robertson, P., 1977, Lamar University, personal communication (February).
- Robertson, V., 1977, State forester - Louisiana State Forestry Commission, personal communication (March).
- Rocca, L., 1976, Louisiana State Wildlife and Fisheries Commission, personal communication (May).
- _____, 1977, Louisiana State Wildlife and Fisheries Commission, personal communication (February).

Sales Management, The Marketing Magazine, 1975, issue (21 July).

Schmidt, G.W., 1973, Interstitial water composition and geochemistry of deep Gulf coast shales and sandstones. Bulletin AAPG, 57, pp. 321-337.

Simpson, R.H. and Lawrence, M.B., 1971, Atlantic hurricane frequencies along the U.S. coastline. NOAA technical memorandum NWS SR-58. Southern Region Headquarters, National Weather Service, Fort Worth, Texas.

Slotta, L.S. and Williamson, K.J., 1974, Estuarine impact, related to dredge spoiling. Proceedings of the 6th Dredging Seminar, Texas A & M University.

Smelser, R.A., 1977, Director - Medical Facilities Planning Division, Texas Department of Health Resources, personal communication (March).

Smith, D.A. and Reeve, F.A.E., 1970, Salt piercement in shallow Gulf Coast salt structures. Bulletin AAPG, vol. 54, no. 7, pp. 1271-1289.

Smithsonian Institution, 1975, Report on endangered and threatened plant species of the United States. Government Printing Office, Washington, D.C., House Document no. 94-51.

Soil Conservation Service, 1965, Soil survey - Jefferson County, Texas. U.S. Department of Agriculture, Beaumont, Texas.

_____, 1969, General soil map - Calcasieu Parish, Louisiana. U.S. Department of Agriculture, Alexandria, Louisiana.

_____, 1971, General soil map - Cameron Parish, Louisiana. U.S. Department of Agriculture, Alexandria, Louisiana.

_____, 1975, Procedure for computing sheet and rill erosion of project areas. U.S. Department of Agriculture, Engineering Division and Plant Science Division, Tech. Rel. 51.

South East Texas Regional Planning Commission, 1972, Population projections. Nederland, Texas.

Stickele, W., 1976, personal communication (March).

- Stone, J.H. and Robbins, J.M. (with sections by D.B. Johnson, R.M. Pope, J.G. Gosselink, H.C. Loesch, and J.W. Day, Jr.), 1973, Recommendations for the Environmental Protection Plan. Louisiana Superport Studies, Final Report Submitted to Louisiana Deep Draft Harbor and Terminal Authority under contract no. 168-20-F652/F653.
- Swanton, J.R., 1911, Indian tribes of the lower Mississippi Valley and adjacent coast of the Gulf of Mexico. Bureau of American Ethnology. Bulletin no. 43. Government Printing Office. Washington, D.C.
- _____, 1946, The Indians of the southeastern United States, Bureau of American Ethnology. Bulletin no. 137. Government printing office. Smithsonian Institution. Washington, D.C.
- Tarver, J. W. and Dugas, R.J., 1973, A study of the clam, Rangia cuneata, in Lake Ponchartrain and Lake Maurepas, Louisiana. Louisiana Wildlife and Fisheries Commission, technical bulletin no. 5, 97 pp.
- Tarver, J. W., 1972, Occurrence, distribution, and density of Rangia cuneata in lakes Pontchartrain and Maurepas, Louisiana. Louisiana Wildlife and Fisheries Commission, technical bulletin no. 1.
- Taylor, R.E., 1938, Origin of the caprock of Louisiana salt domes. Department of Conservation, Louisiana Geological Survey, Geological Bulletin no. 11.
- Texas Historical Commission, 1975, Guide to official Texas historical markers.
- Texas State Highway Department, 1973, 1973 Traffic map, Jefferson County. Planning Survey Division.
- Texas Water Quality Board, 1975, Intensive surfacd water monitoring survey for segment 0701 - Taylor Bayou. report no. IMS 16, Austin, Texas.
- Thom, H.C.S., 1968, New distributions of extreme winds in the U.S. J of Structural Division, ASCE, vol. 94, no. 3T7, procedure paper 6038.
- Thomas, J.D., 1975, Benthos. In Gosselink, J.G. et al. (eds.), Environmental Assessment of a Louisiana Offshore Oil Port, Technical Appendices, vol. III, Louisiana State University, Center for Wetland Resources, report for LOOP, Inc.
- Thomas, P.M., Jr., Campbell, L.J., and Montagne, T.D., 1977, Archaeological reconnaissance in West Louisiana and East Texas: Texoma Group Strategic Petroleum Reserve Sites. Institute for Maya and New World Research. Report of Investigations no. 1, New Orleans, Louisiana

- Thompson, S.A. and Eichelberger, O.H., 1928, Vinton salt dome Louisiana. Bulletin AAPG, vol. 12, no. 4, pp. 385-394.
- University of Texas, 1974, Rare and endangered plants native to Texas. Rare Plant Study Center, Austin, Texas.
- U.S. Army Corp of Engineers, 1975a, Draft environmental statement, Gulf Intracoastal Waterway; Petit Anse, Tigre and Carlin Bayous; and Bayou Grosse Tete, Louisiana. New Orleans, Louisiana.
- _____, 1975b, Final environmental statement, Maintenance dredging Sabine-Neches Waterway, Texas. Galveston, Texas.
- _____, 1975c, Waterborne commerce of the United States, part 2: waterways and harbors: Gulf Coast, Mississippi River system and antilles, calendar year 1975.
- U.S. Department of Agriculture, 1973, Rice in the United States: varieties and production. Agriculture Handbook no. 289, Washington, D.C.
- U.S. Department of Commerce, 1967-1969, Climatological data environmental data service.
- _____, 1972, County-City data book.
- _____, 1974, County business patterns.
- U.S. Environmental Protection Agency, 1976a, EPA notice. 41 FR 29481 (16 July).
- _____, 1976b, Hydrocarbon/photochemical oxidant control strategy for the state of Texas. Technical support document, EPA 906/9-76-001.
- U.S. Fish and Wildlife Service, 1974, Birds of Sabine National Wildlife Refuge. U.S. Department of the Interior, Washington, D.C., RF 4358200-2.
- _____, 1975, Threatened or endangered fauna or flora, review of vascular plants and determination of "critical habitat". U.S. Department of the Interior, Washington, D.C. Federal Register, vol. 40, no. 127, pp. 27824-27924.
- _____, 1976, Endangered and threatened species, plants. U. S. Department of the Interior, Washington, D.C. Federal Register, vol. 41, no. 117, pp. 42524-24572.
- U.S. Geological Survey, 1975, Water resources data for Texas, water year 1975. U.S. Geological Survey water-data report TX-75-1, vol. 1.
- Van Hinte, J.E., 1976, 1976 A Jurassic time scale. Bulletin AAPG, vol. 60, pp. 489-497.

- Wagner, B.A., 1976, U.S. Fish and Wildlife Service, personal communication (December).
- Wallace, W.E., 1966, 1966 Edition fault and salt dome map of southern Louisiana. Transactions of the Gulf Coast Association of Geological Societies, vol. XVI.
- Wessleman, J.B., 1973, Ground-water resources of Chambers and Jefferson counties, Texas. Texas Water Development Board, Austin, Texas, report 133.
- White, C. J. and Perret, W. M., 1974, Efforts to reestablish oyster tonging reefs in Calcasieu Lake, Louisiana. Louisiana Wildlife and Fisheries Commission, technical bulletin 11.
- White, C.J., 1976a, Louisiana Wildlife and Fisheries Commission, personal communication (March).
- _____, 1976b, Louisiana Wildlife and Fisheries Commission, personal communication (May).
- Woodmansee, R.A., 1966, Daily vertical migration of Lucifer, planktonic numbers in relation of solar and tidal cycles. Ecology 47: 847-850.
- Wyatt, L.B., 1977, Texas Water Quality Control Board, personal communication (January).

Available from:

**National Technical Information Service (NTIS)
U.S. Department of Commerce
5285 Port Royal Road
Springfield, Virginia 22161**

**Price: Printed Copy: \$20.00
 Microfiche: \$20.00**

Sold in 5 Volume Sets Only.